

BTS E5 ... E20-DS5

Installation and operating manual

Version 01 | November 2022

English

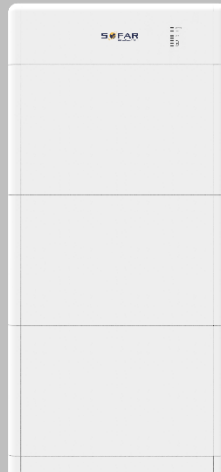

BTS E5-DS5, E10-DS5, E15-DS5, E20-DS5

Table of Contents

1	About this manual	5
1.1	Copyright declaration	5
1.2	Structure of the manual	5
1.3	Scope	6
1.4	Target group	6
1.5	Symbols used	6
2	Basic safety information	8
2.1	Safety information	8
2.2	Symbols and signs	15
3	Product features	18
3.1	Product introduction	18
3.2	BTS battery system components	19
3.3	Product dimensions	20
3.4	Labelling on the device	20
3.5	Battery capacity expansion	21
4	Installation	23
4.1	Installation information	23
4.2	Examination before installation	24
4.3	Connections	28
4.4	Tools	29
4.5	Installation location	31
4.6	Installation of the battery system	33
5	Electrical connections	38

5.1	Safety instructions	38
5.2	Electrical connection	39
5.3	Connecting the PE cable	39
5.4	Connecting the power cables	40
5.5	Connecting the communication cables	42
5.6	Connecting the inverter	44
5.7	Parallel system setup	53
5.8	Replacing the fuse	54
5.9	Installing the protective cover	55
6	Commissioning the battery system	56
6.1	Safety check before commissioning	56
6.2	Initial startup	56
6.3	Setting the parameters	56
6.4	Software update	57
6.5	Shutdown procedure	58
7	Operation of the device	59
7.1	Control panel and display field	59
8	Troubleshooting handling	62
8.1	Troubleshooting	62
8.2	Maintenance	64
9	Manufacturer's warranty and liability terms	67
9.1	Warranty period	67
9.2	Warranty void	67
10	Technical data	69

1 About this manual

This manual contains important safety information that must be observed during installation and maintenance of the device.

Carefully read this manual before use and retain it for future reference!

This manual must be treated as an integral component of the device. The manual must be kept in close proximity to the device, including when it is handed over to another user or moved to a different location.

1.1 Copyright declaration

The copyright of this manual is owned by SOFARSOLAR. It may not be copied – neither partially nor completely – by companies or individuals (including software, etc.) and must not be reproduced or distributed in any form, or with the appropriate means.

SOFARSOLAR reserves the right to final interpretation. This manual may be amended following feedback from users or customers. Please consult our website at <http://www.sofarsolar.com> for the latest version.

The current version was updated on 05/12/2022.

1.2 Structure of the manual

This manual contains important safety and installation instructions that must be observed during installation and maintenance of the device.

1.3 Scope

This product manual describes the installation, electrical connection, commissioning, maintenance and troubleshooting of the BTS E5...20-DS5 energy storage system. The series includes the following models: BTS E5-DS5, BTS E10-DS5, BTS E15-DS5, BTS E20-DS5

1.4 Target group

This manual is intended for specialist electrical engineers who are responsible for the installation and commissioning of the energy storage system in the PV system, as well as the PV system operators.

1.5 Symbols used

This manual contains information on safe operation and uses symbols to ensure the safety of persons and property as well as the efficient operation of the inverter. Please read through the following symbol explanations carefully in order to prevent injury or property damage.

⚠ DANGER

Non-observance will result in death or serious injury.

- Follow the warnings in order to prevent death or serious injury!

⚠ WARNING

Non-observance may result in death or serious injury.

- Follow the warnings in order to prevent serious injury!

⚠ CAUTION

Non-observance may result in minor injury.

- Follow the warnings in order to prevent injury!

ATTENTION

Non-observance may result in property damage!

- Follow the warnings in order to prevent damage to or destruction of the product.

NOTE

- Provides tips essential to the optimal operation of the product.

2 Basic safety information

NOTE

- The installation of the BTS battery system must be in full compliance with national and local laws and regulations.
- SOFARSOLAR is not responsible for any personal injury or property damage caused by improper use.
- If you have any questions or problems after reading the following information, please contact SOFARSOLAR.

This section contains safety information that must be observed at all times when working on or with batteries. To prevent personal injury or property damage and to ensure long-term operation of the batteries, read this section carefully and observe all safety information at all times.

2.1 Safety information

WARNING

- Do NOT carry out repairs on the device yourself; this may lead to injury or property damage.
- Before installing the device or carrying out maintenance on it, you must open the DC switch, for the high voltage may cause serious injury.

Read and understand the instructions within this manual and familiarise yourself with the relevant safety symbols in this chapter before beginning with the installation and commissioning of the device.

Please contact the nearest authorised service centre if any maintenance or repairs are required. Please contact your dealer to obtain information about your nearest authorised service centre. Do NOT carry out repairs on the device yourself; this may lead to injury or property damage.

Before installing the device or carrying out maintenance on it, you must open the DC switch. Not doing this may result in serious injury.

2.1.1 Qualified personnel

Personnel tasked with the operation and maintenance of the device must have the qualifications, competence and experience required to perform the described tasks, while also being capable of fully understanding all instructions contained within the manual. For safety reasons, this battery system may only be installed by a qualified electrician who:

- has received training on occupational safety, as well as the installation and commissioning of electrical systems
- is familiar with the local laws, standards and regulations of the grid operator.
- the installer should have joined into the technical training from Sofarsolar or our partners.

SOFARSOLAR assumes no responsibility for the destruction of property or any injuries to personnel caused by improper usage.

2.1.2 Installation requirements

Please install the battery system according to the information contained in the following sections. Install the battery system at a location where it can be fixed and ensure that the inverter is upright. Choose a suitable

place for the installation of electrical devices. Ensure that there is sufficient space for an emergency exit which is suitable for maintenance. Ensure sufficient ventilation in order to guarantee an air circulation for the cooling of the environment. Air humidity should be less than 90% during assembly.

2.1.3 Transport requirements

ATTENTION

- Battery modules must be placed in the original packaging or other suitable packaging during transport to prevent any damage.
- Please carry out a thorough inspection of the product. If you find any packaging problems that may have caused damage to the battery, or if you find any visible damage to the battery, please inform the responsible shipping company immediately. Contact your installer or SOFARSOLAR for help if necessary.

Products are in good electrical and physical condition when they are shipped out from the factory. The factory packaging is specifically designed to prevent transport damage, i.e. violent shocks, moisture and vibrations. The device must not be installed if the packaging or the product is visibly damaged.

The battery modules are classified as Class 9 dangerous goods according to UN38.3 standards. Therefore, they must be loaded and unloaded in accordance with the laws, regulations and industry standards of the region in which they are transported. Rough handling

may result in short-circuiting or damage to the batteries in the box, which may lead to leakage, rupture, explosion or fire.

NOTE

Ensure any transport takes place in compliance with the following standards:

- Sea transport must take place in full compliance with the IMDG Code.
- Land transport must take place in full compliance with ADR or JT/T617 transport requirements.
- Compliance with the regulatory requirements of the transport authorities of the country of origin, route and destination of the transport.
- Compliance with the IMDG Code and the regulatory requirements of the respective national transport authorities.

2.1.4 Storage requirements

ATTENTION

Can cause damage to property if disregarded!

- Select a dry, tidy area that is well-ventilated.
- Ambient temperature range: -10°C to 45°C .
- Relative humidity: 5 to 70%.
- Place the battery module correctly, not upside down or on its side.
- If the battery module has been stored for a long period of time, recharge the power supply periodically. Battery module power supply requirements: the charging current is less than or equal to 7 A, and the battery module needs to be charged to 50% SOC.

Please refer to chapter 8.2 for recharge requirements during storage.

2.1.5 Labelling on the device

The labels must NOT be concealed by items and foreign objects (rags, boxes, devices, etc.); they must be regularly cleaned and kept clearly visible at all times.

2.1.6 Electrical connection

Observe all applicable electrical regulations when working with the solar inverter.

 **DANGER**

Dangerous DC voltage

- Before establishing the electrical connection, cover the PV modules using opaque material or disconnect the PV generator from the inverter. Solar radiation will cause dangerous voltage to be generated by the PV generator!

 DANGER**Danger through electric shock!**

- All installations and electrical connections may only be carried out by trained electricians!

IMPORTANT**Authorisation for grid feed-in**

- Obtain authorisation from the local power grid operator before connecting the inverter to the public power grid.

NOTE**Voiding of guarantee**

- Do not open the inverter or remove any of the labels. Otherwise, SOFARSOLAR shall assume no guarantee.

2.1.7 Operation** DANGER**

Electric shock

- Contact with the electrical grid or the device's terminals may result in an electric shock or fire!
- Do not touch the terminal or the conductor which is connected to the electrical grid.
- Follow all instructions and observe all safety documents that refer to the grid connection.

CAUTION

Burning due to hot housing

- While the inverter is being operated, several internal components will become very hot.
- Please wear protective gloves!
- Keep children away from the device!

2.1.8 Repair and maintenance

DANGER

Dangerous voltage!

- Before carrying out any repair work, first switch off the AC circuit breaker between the inverter and power grid, and then the DC switch.
- After switching off the AC circuit breaker and the DC switch, wait a minimum of 5 minutes before starting any maintenance or repair work.

IMPORTANT

Unauthorised repairs!

- Following the elimination of any faults, the inverter should be fully functional once more. Should any repairs be required, please contact a local authorised service centre.
- The internal components of the inverter must NOT be opened without the relevant authorisation. Shenzhen SOFARSOLAR Co., Ltd. assumes no responsibility for any resulting losses or defects.

2.2 Symbols and signs

CAUTION

Beware of burning hazards due to the hot housing!

- While the inverter is in operation, only touch the display and the buttons, as the housing can become hot.

ATTENTION

Implement earthing!

- The PV generator must be earthed in accordance with the requirements of the local power grid operator!
- For reasons of personal safety, we recommend that all PV module frames and inverters of the PV system are reliably earthed.

⚠ WARNING





Damage due to overvoltage

- Ensure that the input voltage does not exceed the maximum permissible voltage. Overvoltage may cause long-term damage to the inverter, as well as other damage that is not covered by the warranty!





2.2.1 Symbols on the battery system

Several symbols pertaining to safety can be found on the battery system. Please read and understand the content of these symbols before starting the installation.

Battery distribution unit (BDU)

Symbol	Description
	Beware of high voltage and electric shock.
	Caution! Hot surface
	Earthing point
	Please read the manual before installing the battery system

Battery module

Symbol	Description
	<p>Residual voltage is present in the battery module! Before carrying out any maintenance, you should wait five minutes to ensure that the capacitor has been fully discharged.</p>
	<p>Beware of high voltage and electric shock.</p>
	<p>Caution! Hot surface</p>
	<p>Earthing point</p>
	<p>Please read the manual before installing the battery system</p>

3 Product features

This chapter describes the product features, dimensions and efficiency levels.

3.1 Product introduction

The BTS E5–E20-DS5 is an intelligent battery system composed of BTS 5K battery module(s) and a BTS 5K-BDU (battery distribution unit). The system operates at high input and output DC voltage. Its modular and stacked design enables a flexible configuration based on the user's specific requirements. The storage capacity ranges from 5 to 40 kWh.

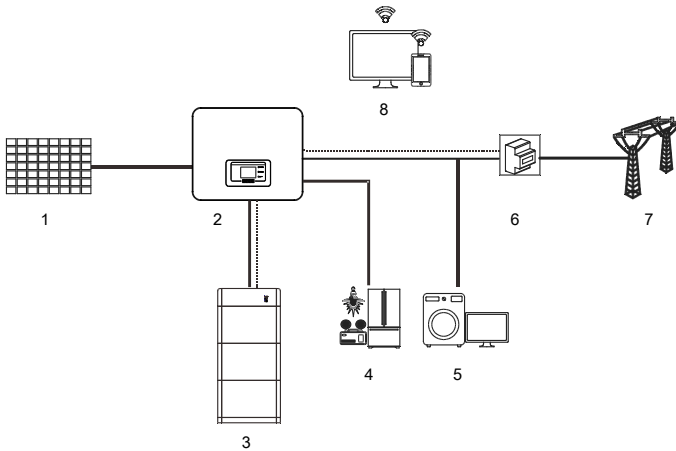

① PV panels	② Hybrid inverter
③ BTS E5...E20-DS5	④ Critical load
⑤ Normal load	⑥ Smart meter
⑦ Grid	⑧ Monitoring platform

The main features include:

- Fully modular design for easy installation and transport
- Balanced current between battery modules for higher available battery capacity
- Expand storage capacity in stages, at any time
- Black start capability to startup the battery without a grid connection
- Low self-consumption of battery power
- User-friendly one-touch start/shutdown function

3.2 BTS battery system components

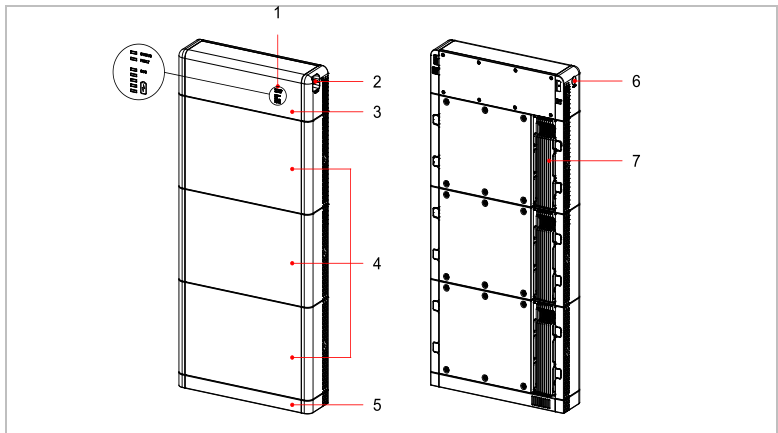

① LED indicator	② DC switch
③ Battery distribution unit	④ Battery module
⑤ Base	⑥ Start button
⑦ Heat sink	

Please refer to below explanation for a full understanding of the BTS battery system naming:

- BTS: Product series name.
- E5/E10/E15/E20: Battery capacity (kWh).
- DS5: Battery module specification (BTS 5K).

3.3 Product dimensions

Please refer to the product dimensions in below table. The dimensions for each setup is given, e.g. 1 battery module in combination with a BDU, 2 battery modules in combination with a BDU, etc.:

Number of BTS 5K	Height (mm)	Width (mm)	Depth (mm)
1	680		
2	1100	708	170
3	1520		

3.4 Labelling on the device

Labelling must not be covered or removed!

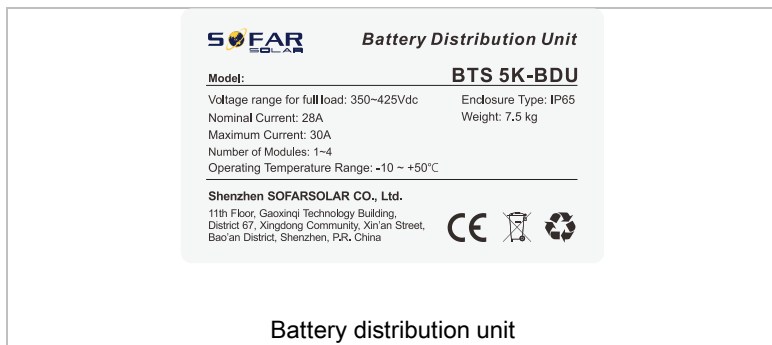

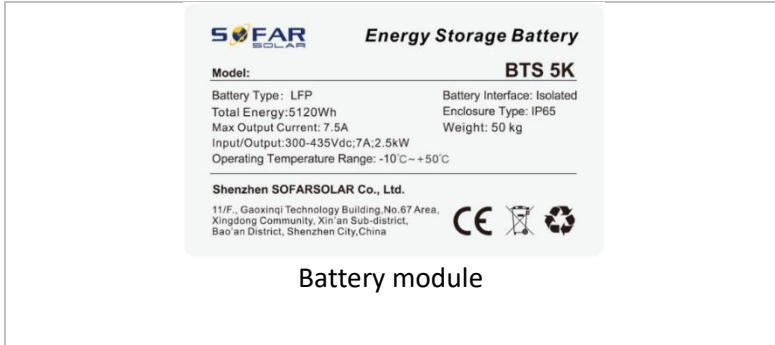

Battery module

3.5 Battery capacity expansion

The BTS battery system series supports capacity expansion. One distribution unit (BDU) can manage up to 4 battery modules (BTS). Up to 2 BDU's can be connected in parallel, with each unit having an independent power connection to the inverter. This way the system capacity can be expanded as follows:

5 to 40 kWh for the inverter HYD 10...20KTL-3PH

5 to 20 kWh for inverters HYD 5...8KTL-3PH

NOTE

- When extending a battery system with more BTS 5K batteries, an extension kit must be used for safety reasons. The optional extension kit include a 2.7m power cable and communication cable, and a base and accessories (SOFAR No. 701.00000068-0)

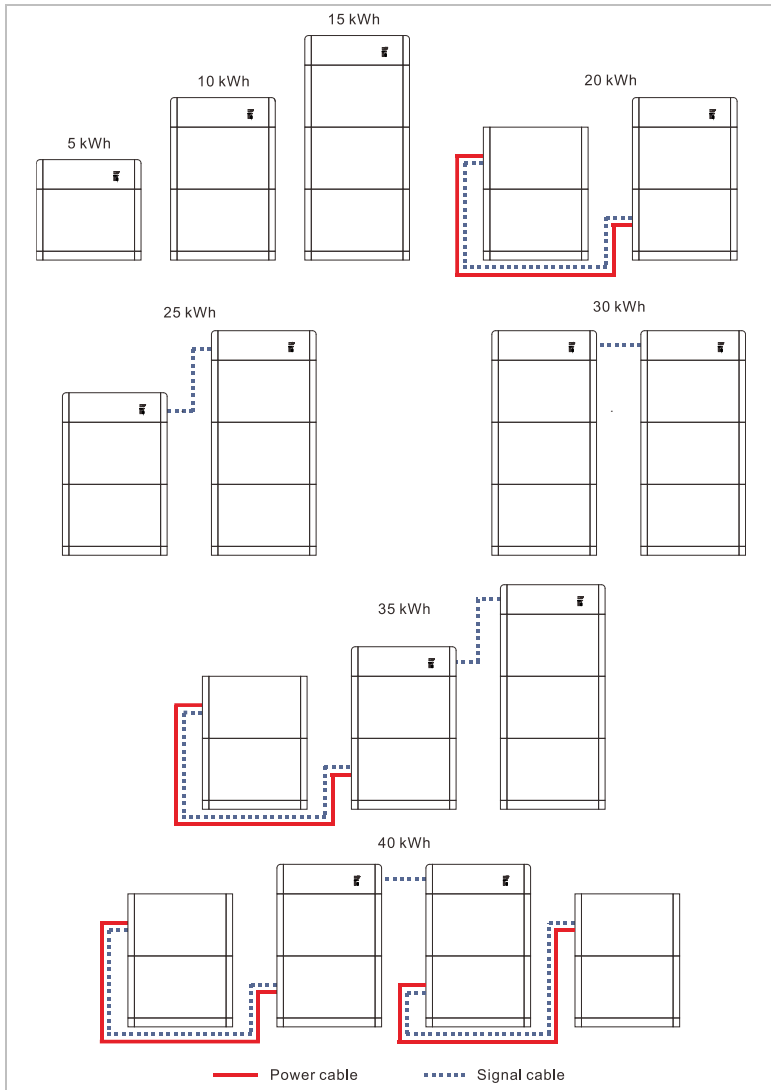

4 Installation

4.1 Installation information

DANGER

Fire hazard

- Do NOT install the battery system on flammable material.
- Do NOT install the battery system in an area in which flammable or explosive material is stored.

CAUTION

Burning hazard

- Do NOT install the inverter in places where it can be accidentally touched. The housing and heat sink may become very hot while the inverter is being operated.

IMPORTANT

Weight of the device

- Take into account the weight of the inverter when transporting and moving it.
- Choose a suitable installation location and -surface.
- Commission a minimum of two persons with the installation of the inverter.
- Do not set down the battery modules upside-down.

4.2 Examination before installation













4.2.1 Checking the external packaging materials

Packaging materials and components may become damaged during transportation. Therefore, the external packaging materials must be examined before installation. Check the external packaging material for damage, e.g. holes and cracks. If you discover any cases of damage, do not unpack the battery modules and battery distribution unit and contact the transport company and/or dealer immediately. It is recommended that the packaging material should be removed within 24 hours before installing the battery system.











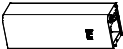



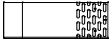

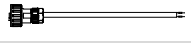
4.2.2 Checking the delivery scope





After unpacking the battery modules and battery distribution unit, check that the delivery items are both intact and complete. In the event of any damage or missing components, contact the wholesaler. Please refer to below lists for all delivery items that are delivered with the battery modules and the battery distribution unit.

Scope of delivery BTS 5K







No.	Image	Description	Quantity
01		Battery module	1
02		Protective cover	2
03		Power cable	2
04		Communication cable	1
05		Anti-tip bracket A	2
06		Side connector	2
07		Anti-tip bracket B	2
08		PE cable	1
09		M6*14 hexagon screw	4
10		M4*10 SEMS screw	10
11		M6*60 expansion bolt	2
12		Termination resistor	1
13		Quality certificate	1

Scope of delivery BTS 5K-BDU (Battery distribution unit)

No.	Image	Description	Quantity
01		Battery distribution unit	1
02		Protective cover left side	1
03		Protective cover right side	1
04		Floor base	1
05		Floor base protective cover	2
06		BDU parallel communication cable	1
07		BMS communication cable	1
08		M6*14 hexagon screw	3
09		M4*10 SEMS screw	10
10		M6*60 expansion bolt	4
11		Battery positive input terminal housing	1
12		Battery negative input terminal housing	1
13		Battery positive input terminal metal core	1
14		Battery negative input terminal metal core	1
15		Anti-tip bracket A	2
16		Side connector	2

17		Anti-tip bracket B	2
18		Manual	1
19		Warranty card	1
20		Quality certificate	1

Scope of delivery BTS 5K Extension Kit (SOFAR No. 701.00000068-0)

No.	Image	Description	Quantity
01		Floor base	1
02		Power cable	2
03		Communication cable	1
04		PE cable	1
05		Manual	1
06		Warranty card	1
07		Quality certificate	1

4.3 Connections

⚠ CAUTION

Damage during transportation

- Please check the product packaging and connections carefully prior to installation.

Battery distribution unit

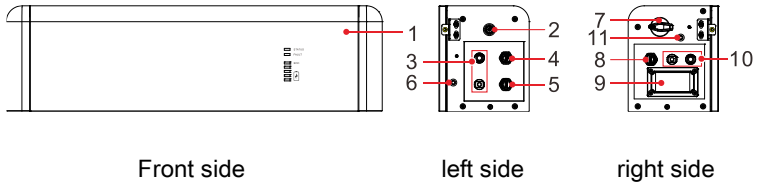

①	BDU	②	Start button
③	BAT power in	④	Link port
⑤	COM in	⑥	Grounding screw
⑦	DC switch	⑧	COM out
⑨	Fuse	⑩	BAT power out
⑪	Grounding screw		

Battery module

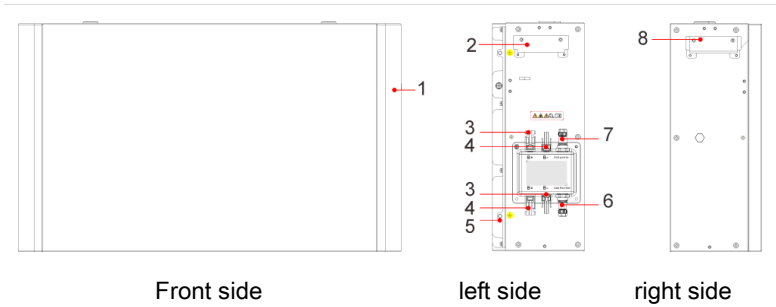









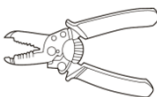

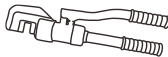
①	Battery module	②	Left handle
③	Output port B+	④	Output port B-
⑤	Grounding	⑥	Link port out
⑦	Link port in	⑧	Right handle

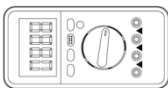
4.4 Tools

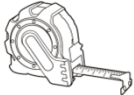
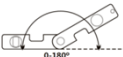
Prepare the tools required for the installation and the electrical connection.

No.	Tool	Model	Function
01		Hammer drill Recommended drill: 8 mm	Used to drill holes in the wall.
02		Screwdriver 4 mm	Removal and installation of screws and wiring

No.	Tool	Model	Function
03		Removal tool	Removal of battery module / distribution unit output terminals
04		Wire stripper	Used to strip the wire
05		Sleeve	Used to installed the support bracket
06		Crimping tool	Used to crimp the OT connectors
07		Heat gun	Used to coat
08		Multimeter	Used to check the wiring and earthing
09		Marker	Used for marking
10		Measuring tape	Used to measure distances
11		Spirit level	Used to align the wall bracket

No.	Tool	Model	Function
12		ESD gloves	for the installer
13		Safety goggles	for the installer
14		Anti-dust respiratory mask	for the installer

4.5 Installation location

Choose a suitable position for the installation of the BTS energy storage system. Ensure that the following requirements have been fulfilled:

- Select a dry, tidy area that is well-ventilated
- Ambient temperature range: -10°C to 50°C
recommended: 10°C to 40°C
- Relative humidity: 5 to 95% (non-condensing)
- No flammable or explosive materials should be present in the vicinity.
- Maximum height: 4000 m above sea level

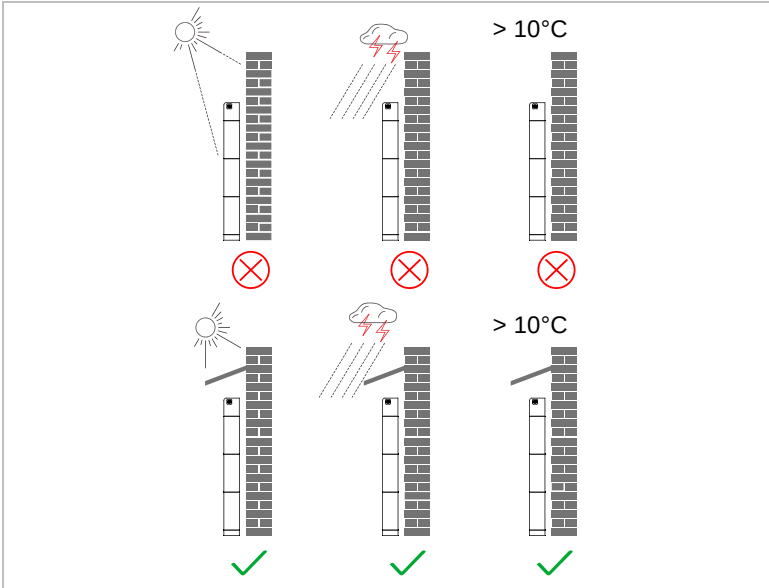

To ensure sufficient space for installation and heat dissipation, please refer to the following clearance distances:

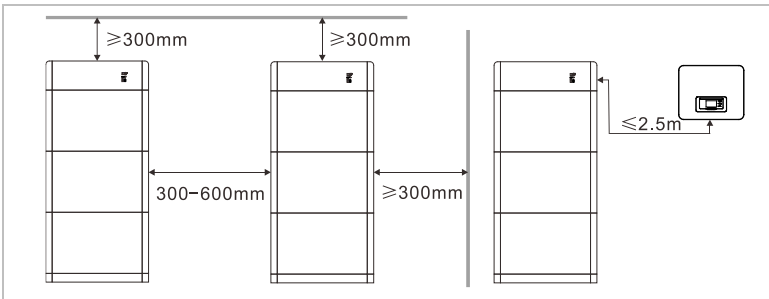

4.6 Installation of the battery system

4.6.1 Floor base

1. Place the base bracket onto a stable ground close to the wall, keeping a distance of 10 to 25 mm, and mark the hole. Put the wall bracket aside and drill the holes.

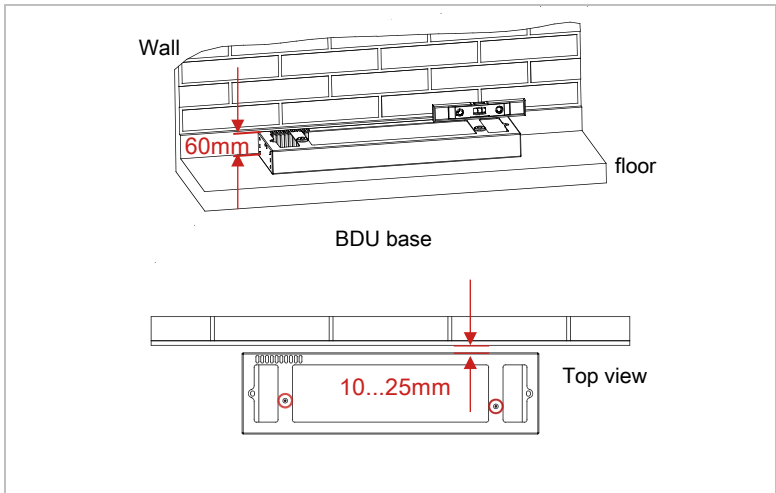

2. Put the base bracket aside and drill the holes (M8 drill bit, 60–65 mm). Then fasten the base to the wall using the M8 screws.

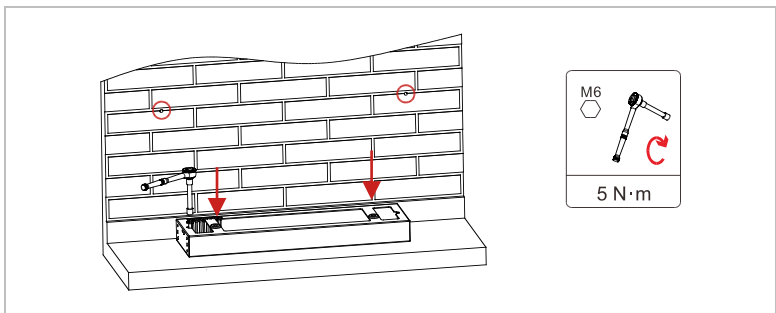

NOTE

- If the holes cannot be drilled on the ground, the battery modules must be secured to the wall.

3. Mark the holes for the battery modules and BDU according to the diagram below:

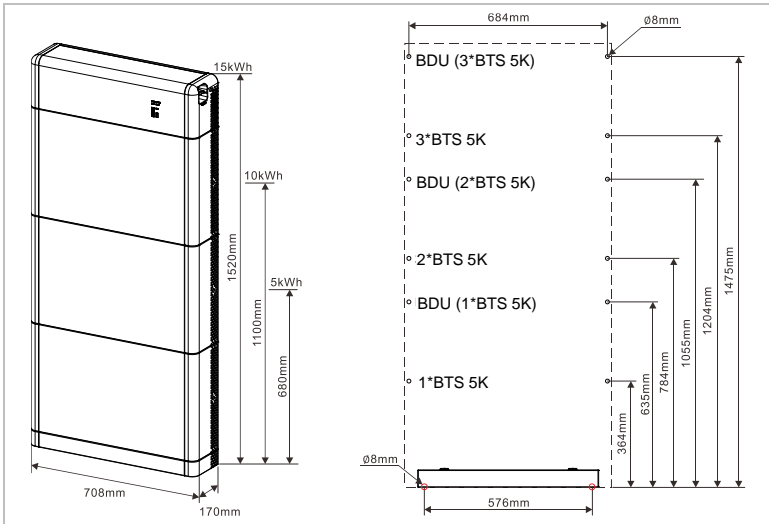

4.6.2 Installing the battery system

- 1 Place the first battery module on the floor base.

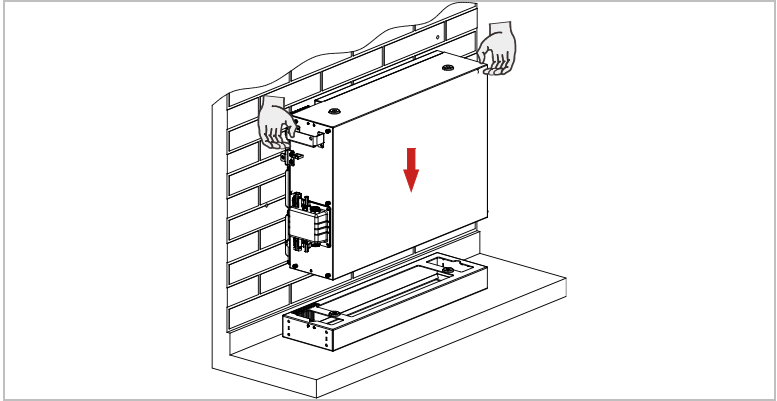

- 2 Secure the module using both side connectors and fasten them with the six M4 screws. in the wall bracket.

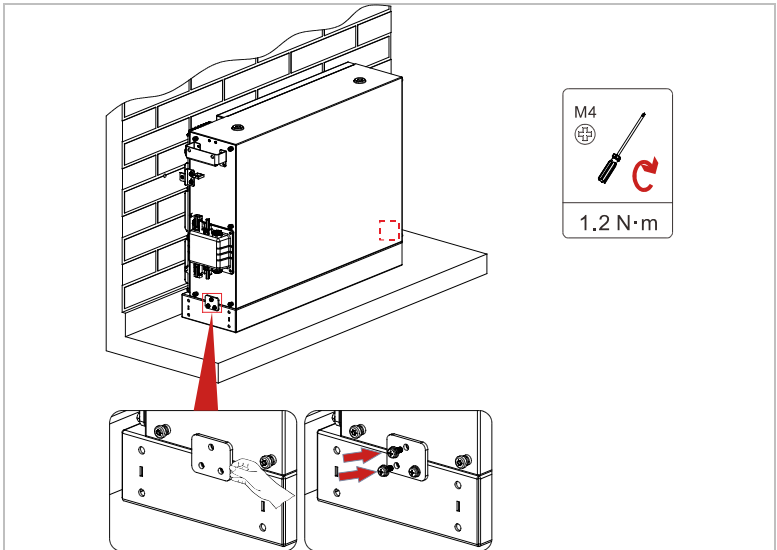

- 3 Install the remaining battery modules and the BDU. Ensure that the side connectors are firmly fastened before installing the next unit.

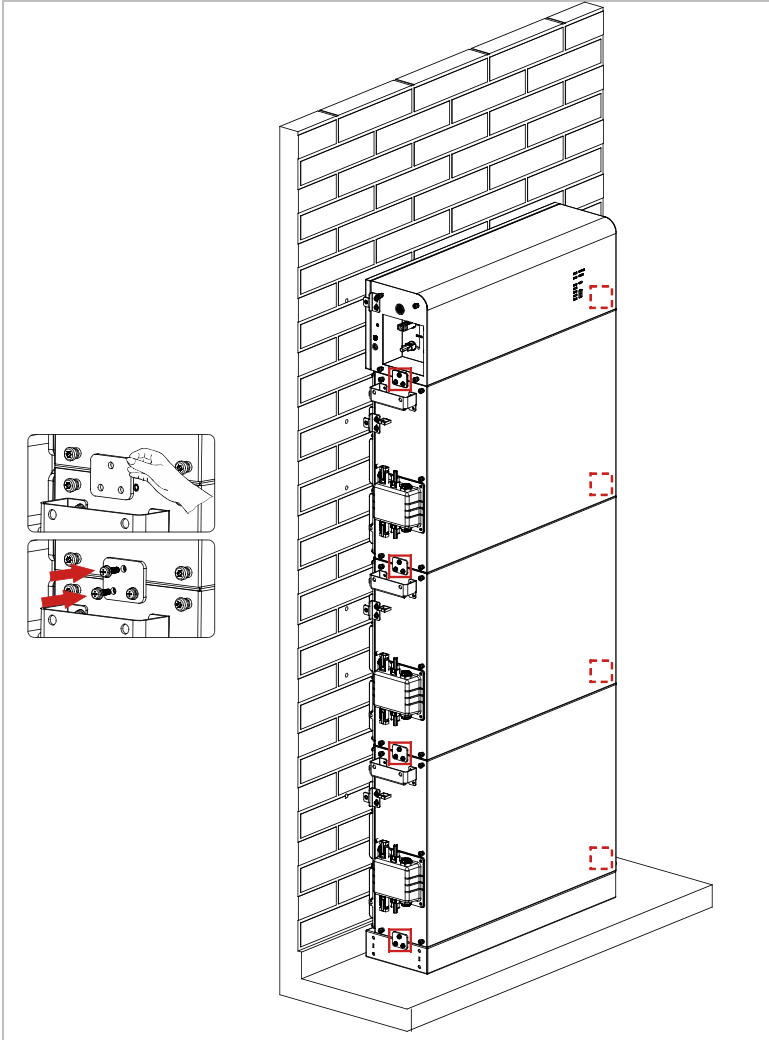

4.6.3 Anti-tip bracket

1. Drill the holes with a hammer drill (\varnothing 8mm, depth range 60-65 mm).
If any error was made, reposition and redrill the holes.
2. Install the anti-tip bracket B to the wall, and fasten the expansion bolt.
3. Adjust anti-tip bracket A to ensure that the connection holes of anti-tip bracket A and anti-tip bracket B are aligned.
4. Fix both anti-tip bracket A and anti-tip bracket B with M6*16 screws.

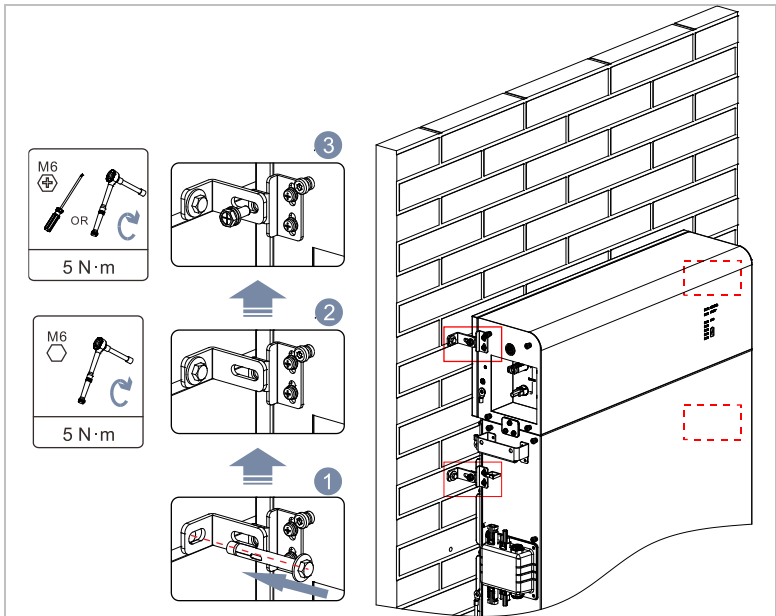

5 Electrical connections

5.1 Safety instructions

This topic describes the electrical connections of the BTS E5–E20-DS5 smart battery system. Read this section thoroughly and carefully before connecting the cables.

ATTENTION

- The installation and maintenance of the battery system must be carried out by a professional electrical engineer.
- During installation and maintenance, operators should wear rubber gloves and protective gloves.
- Before establishing any electrical connection, ensure that the protective earthing is both connected and adequate.

DANGER

Electrical voltage at the DC connections

- Before establishing any electrical connection, ensure that the DC switch and start button of the battery distribution unit are OFF before establishing the electrical connection and that no output voltage is applied to the battery module.
- Ensure that the positive and negative output polarity of the battery is correct before making any electrical connections.

NOTE

- Damage to the equipment caused by incorrect wiring by the operator is not covered by the product warranty.

5.2 Electrical connection

The electrical connection is established as follows:

1. Connect PE cable
1. Connect power cable
2. Connect communication cable

5.3 Connecting the PE cable

NOTE

- The grounding cable can be found in the accessories of the BTS 5K battery module.

Follow the instructions in below diagram. Connect the grounding points of the BDU and battery modules, as well as the grounding points between the different battery modules, with the supplied grounding wire. Ensure that all points are connected securely and reliably.

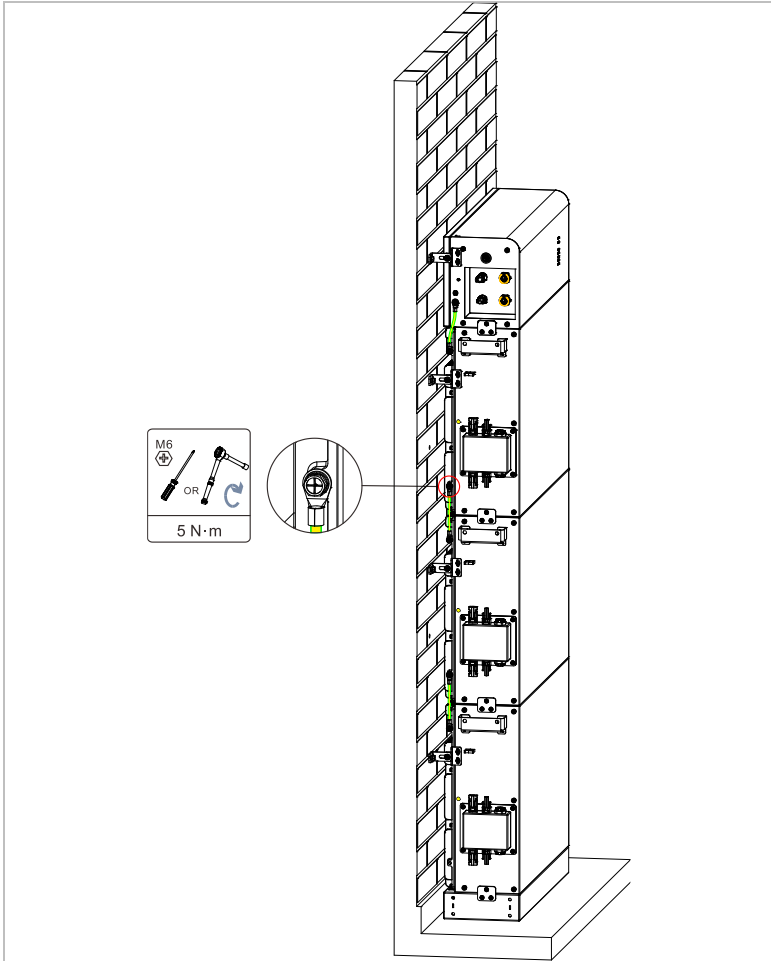

5.4 Connecting the power cables

NOTE

- The power cables can be found in the accessories of the BTS 5K battery module.

Please follow below steps and the diagram:

1. Connect the BAT IN port of the BDU to the positive and negative terminals (B+, B-) of the battery modules.
2. Connect the positive and negative terminals (B+, B-) between the battery modules from top to bottom. Secure all cables using cable ties and ensure that the connections are secure and reliable.

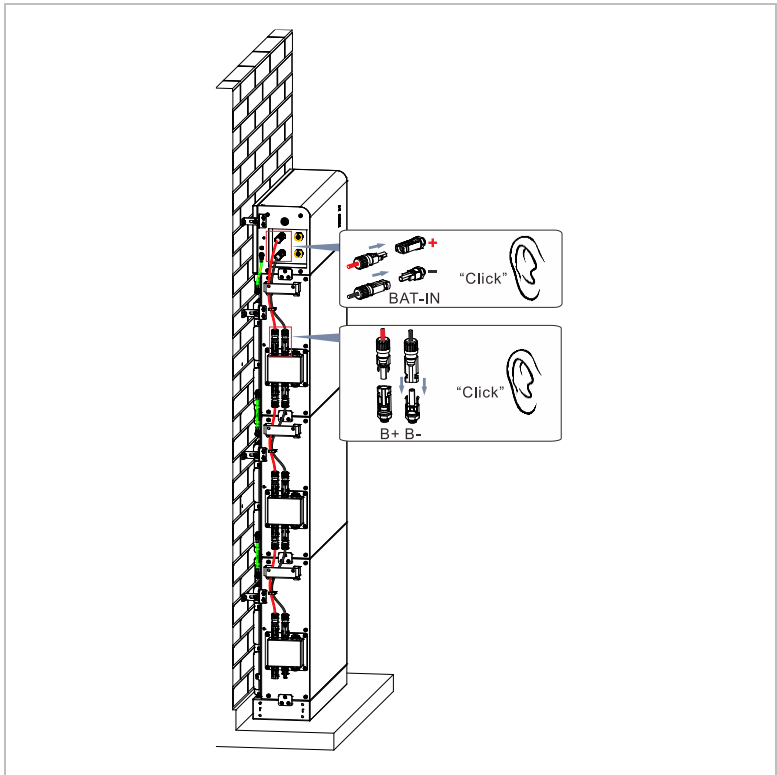

5.5 Connecting the communication cables

NOTE

- The communication cables can be found in the accessories of the BTS 5K battery module.

Please follow below steps and the diagram:

1. First connect the BDU (COM IN) to the top battery module (Link Port In) with the communication cable. Then connect the remaining battery modules by connecting the Link Port Out to the Link Port In of the other modules. Lock the cable by rotating it clockwise to ensure a secure and reliable connection, and finally secure them with cable ties.

2. To ensure reliable battery communication, a terminal resistor must be installed on the Link Port Out of the last battery module in the system. Rotate the nut clockwise to ensure a proper connection.

NOTE

- Not installing a termination resistor may cause battery communication failure.
-

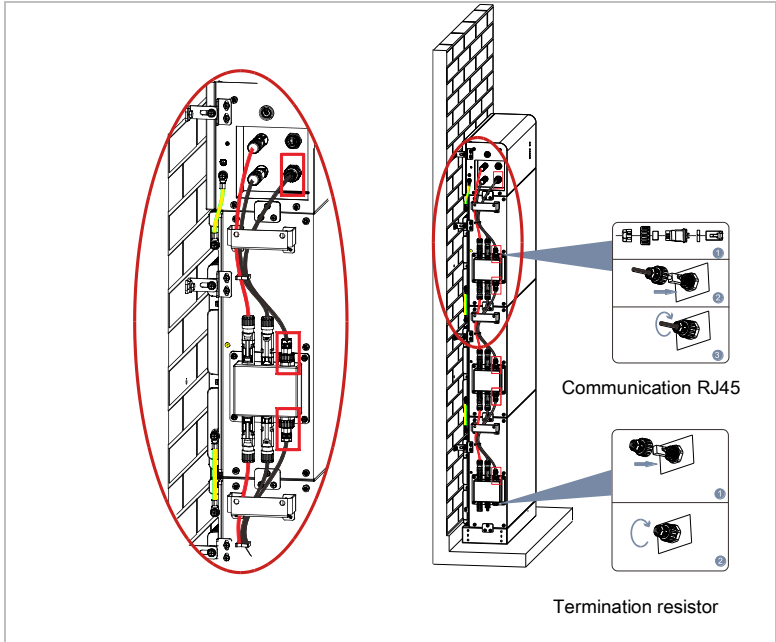

A single 20 kWh battery system must be installed in two rows. Connect the power cables (B+, B-) and communication cable (Link Port In) from the top battery module of the first row (without the BDU) to the bottom battery module of the other row (B+, B- and Link Port In).

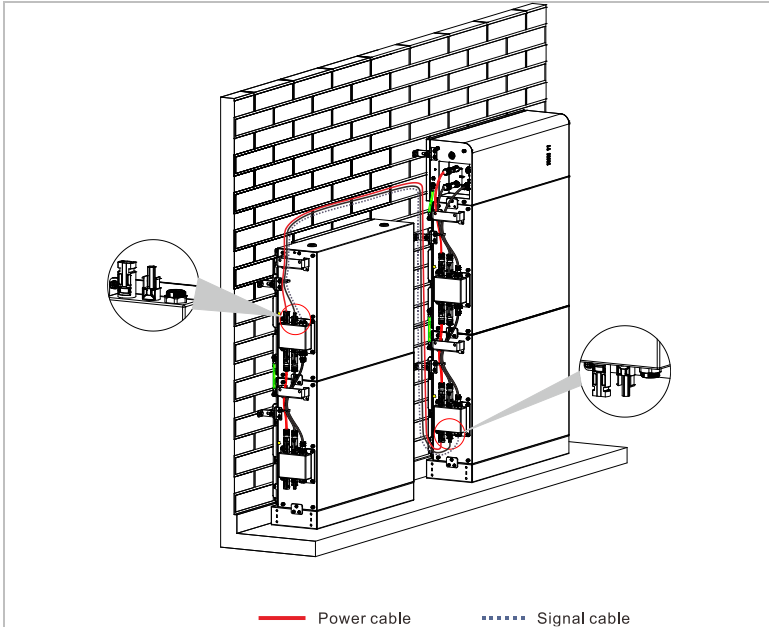

NOTE

- When extending a battery system with more BTS 5K batteries, an extension kit must be used for safety reasons. The optional extension kit include a 2.7m power cable and communication cable, and a base and accessories (SOFAR No. 701.00000068-0)

5.6 Connecting the inverter

Below diagram is an example of how to connect the BTS battery system to SOFARSOLAR's HYD 5...20KTL-3PH, where N and PE are separated (TNC-S, TNS)

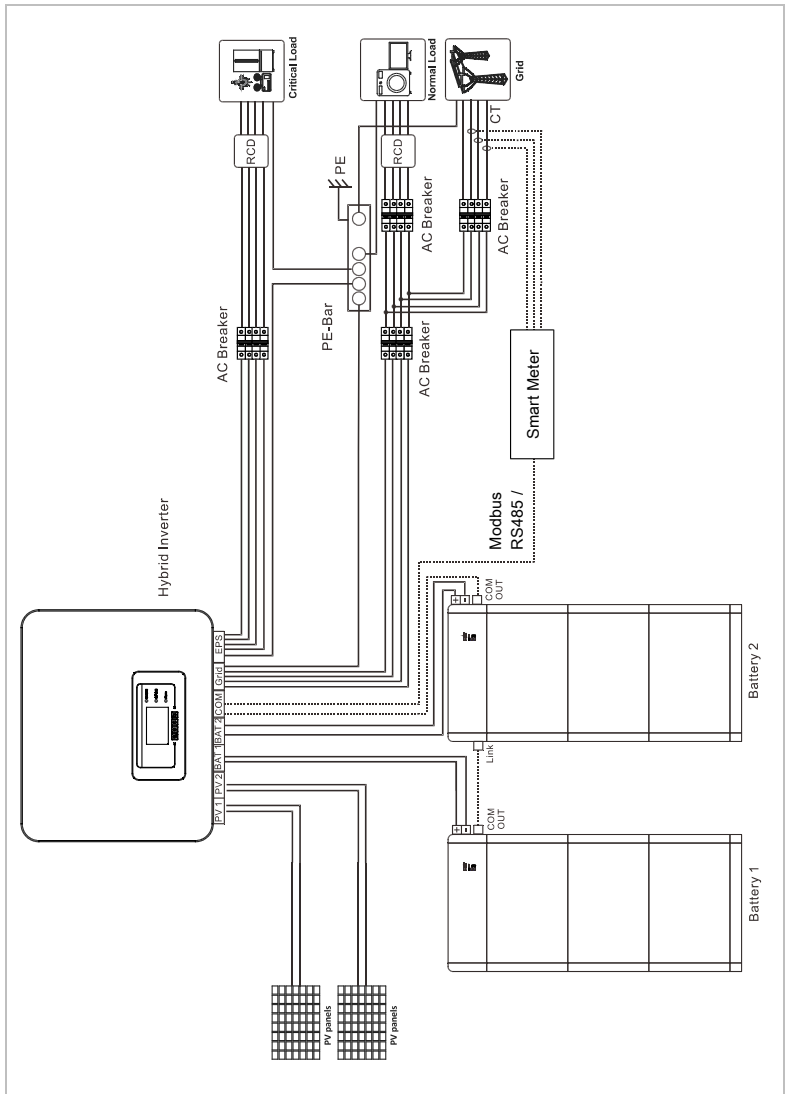

Below is the schematic connection diagram of a system where the neutral line and ground line are connected together (TNC)

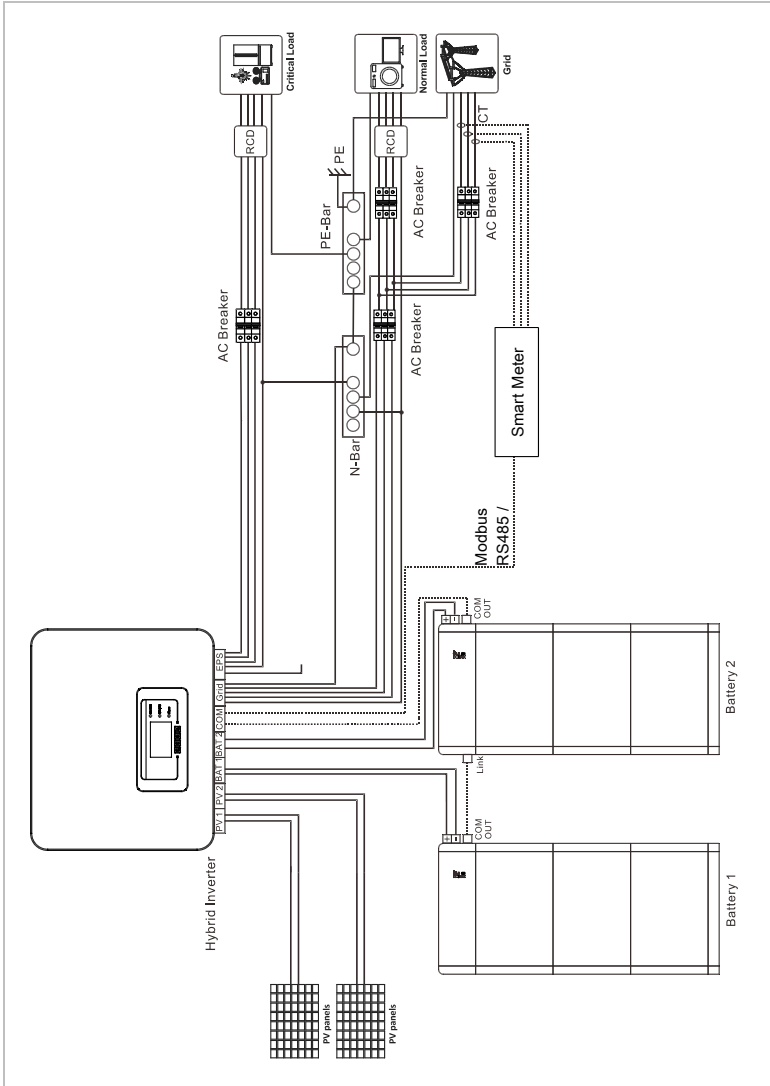

NOTE

- In certain regions there are specific local safety requirements of the power grid. Ensure to comply with all local safety requirements.
- According to the Australian safety regulations, the neutral cables on the grid-connected side and EPS side must be connected together. Otherwise the EPS cannot be used.

5.6.1 Connecting the PE cable

Please follow below steps and the diagram:

1. Crimp the OT terminals by following below diagram.

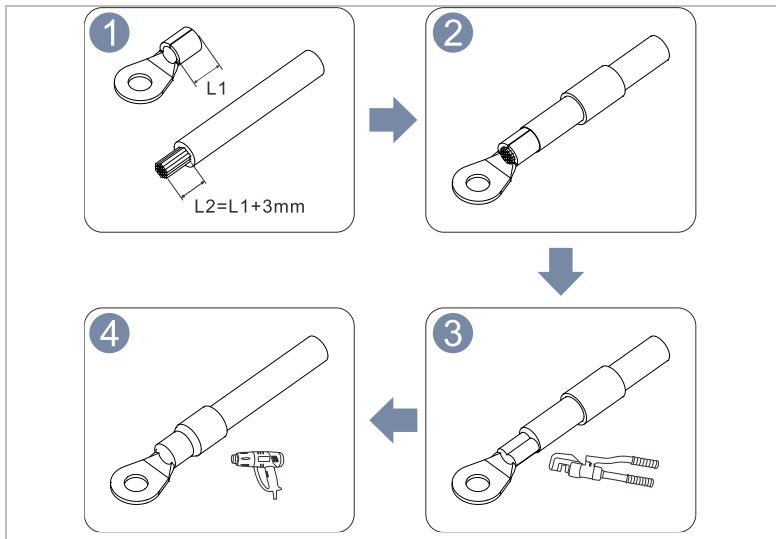

ATTENTION

- Avoid scratching the core of the cable when stripping it.
 - The grounding cable must be $\geq 4\text{mm}^2$ and meet the requirements for outdoor use.
 - The cavity formed by crimping the conductor of the OT terminal should be completely covered with the wire core and the core should be tightly bonded to the OT terminal without loosening. The pulling force after crimping should be in accordance with UL486A and UL310.
2. Install the grounding cable by connecting it from the right side of the BDU to an external earth protection point, as shown in below picture.

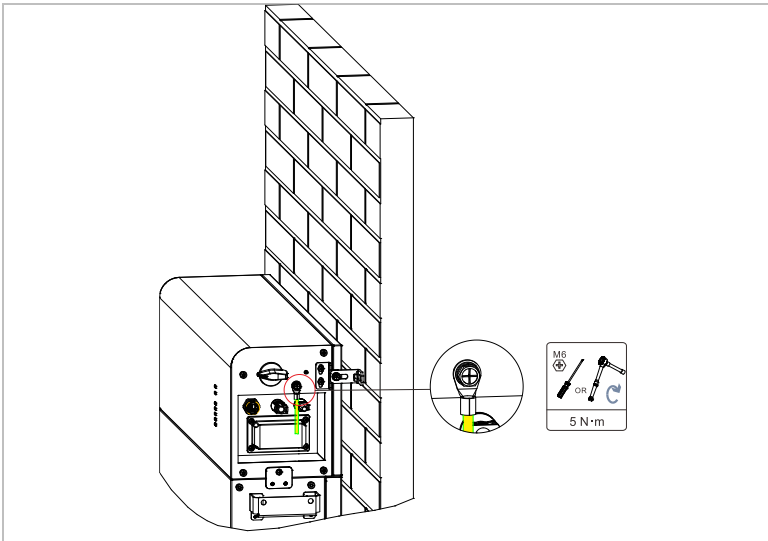

5.6.2 Connecting the DC power cables

NOTE

- The recommended power cable specifications: 4...6mm².

Please follow below steps and the diagram:

1. Select a proper cable type based on the specifications above. Remove the cable glands from the positive and negative connectors. It is recommended to use different colours to distinguish between the positive and negative connectors.
2. Use a wire stripper to strip off the insulation layer of both the positive and negative power cables. Please refer to below diagram for the exact length.

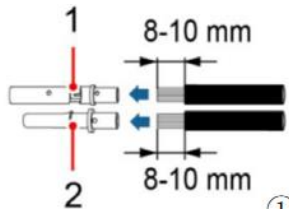

- ① Positive metal contact ② Negative metal contact

3. Insert the stripped cables into the positive and negative metal terminals. Use the crimping pliers to press the cable to the metal core of the terminals, to ensure that the cable is firmly crimped.

4. Guide the crimped cables through the locking nuts and into the corresponding plastic shells until a click is heard. The click indicates that the metal cores are now in place. Tighten the locking nuts.

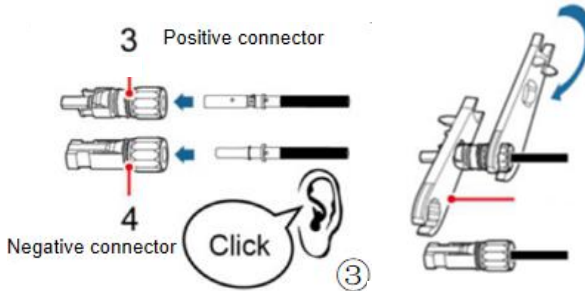

③ Positive connector

④ Negative connector

5. Use a multimeter to check the positive and negative poles. After confirming that they are correct, the cables can be connected from the B+/B- input terminals to the corresponding BAT inputs of the inverter. Ensure a secure and reliable connection.

To remove the connectors from the battery module or the BDU, use the removal tool as shown below.

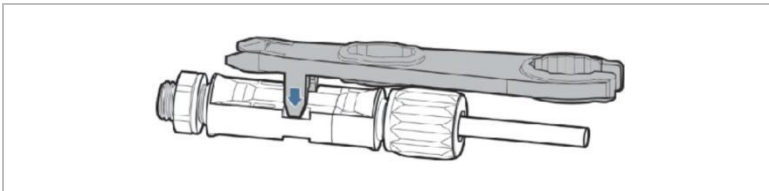

NOTE

- To avoid cable breakage, it is recommended not to use hard DC input cables, such as armoured cables.
- Before assembling the DC connector, ensure that the cable polarity is correct and label the positive and negative cables properly.
- After crimping the positive and negative metal terminals, pull back on the DC input cable to ensure that the cable is tightly connected.
- If the capacity of a single battery system is more than 15 kWh, the batteries should be installed and connected in two columns.

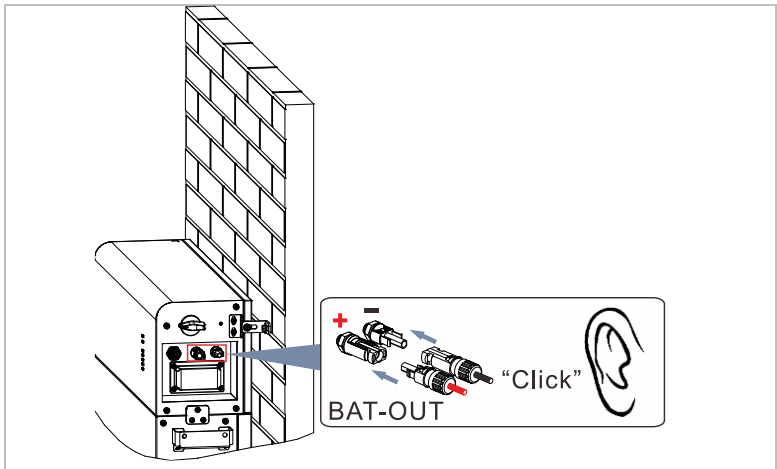

5.6.3 Connecting the BMS communication cable

Connect the supplied communication cable from the COM OUT Port of the BDU to the inverter's BMS communication ports CAN-H and CAN-L respectively according to the label definition.

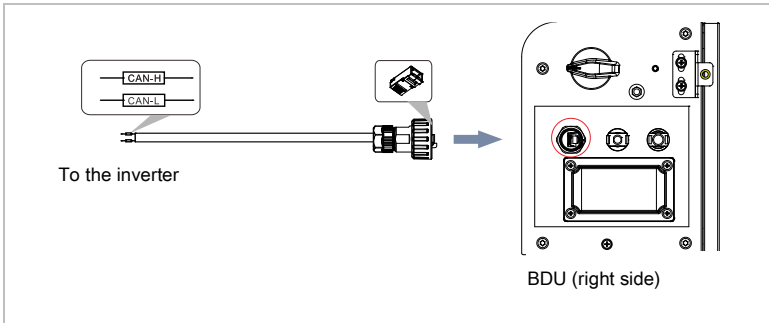

The pin definitions of the COM OUT Port of the BDU are given below:

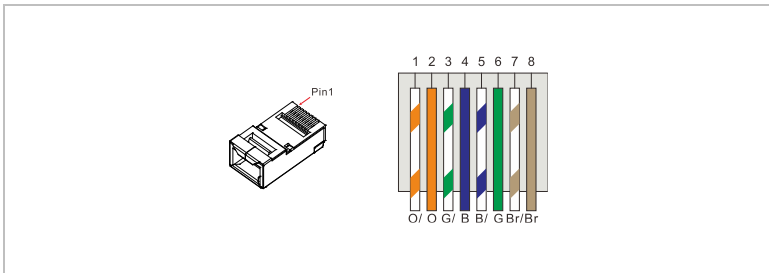

COM Port	Function	Communication Cable BTS	„Link In“ connector Battery
HYD 5..20KTL-3PH			
Pin 7	CAN0_H	Blue	Pin 4
Pin 8	CAN0_L	Blue-white	Pin 5

5.7 Parallel system setup

The BTS battery system supports the parallel operation of up to two systems. Follow below diagram for the correct wiring:

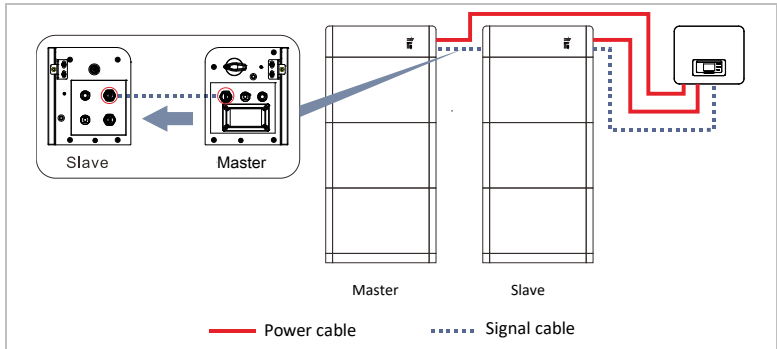

The power cables are connected from the BDUs to the inverter separately. The communication cables determine which system acts as the Master or Slave system: the Slave system is directly connected to the inverter. The parallel communication cable is then used to connect the Master system's COM OUT Port to the Slave system's Link Port.

NOTE

- When extending a battery system with more BTS 5K batteries, an extension kit must be used for safety reasons. The optional extension kit include a 2.7m power cable and communication cable, and a base and accessories (SOFAR No. 701.0000068-0)

5.8 Replacing the fuse

If the BDU's fuse is damaged, a professional engineer can replace it.

Please follow below steps:

1. To shut down the battery system, set both the DC switch and start button at the BDU to OFF. All LED indicators of the BDU are now OFF. **Please wait for 5 minutes to ensure that the remaining battery power is completely discharged before proceeding to the next step.**
2. Loosen the four fuse cover screws with a screwdriver and remove the cover.

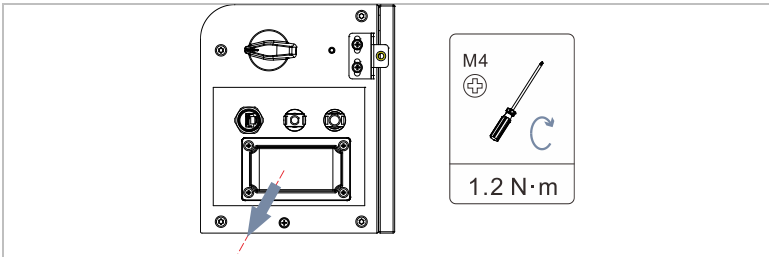

3. Open the fuse box backwards and replace the damaged fuse with a new one. Close the fuse box until a click is heard, which indicates that the fuse box is securely in place.

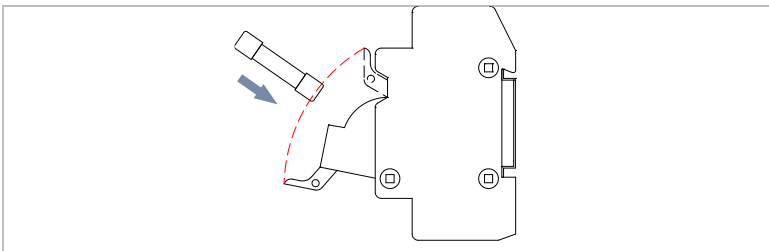

No	Brand	Model	Specifications
1	Sino	RS309-MF-14C40A	Rated voltage: 750 Vdc
2	Bussmann	FWP-40A14Fa	Rated current: 40 A Packaging dimensions: 51*14.3 mm
3	FRZ	FRB-C14-63A	

5.9 Installing the protective cover

After completing and double checking the electrical wiring, the protective cover can be installed. Please follow below steps:

1. Install the protective covers on both sides of the base.
2. Install the protective covers on both sides of the battery modules and BDU.
3. Tighten the covers with the screws.

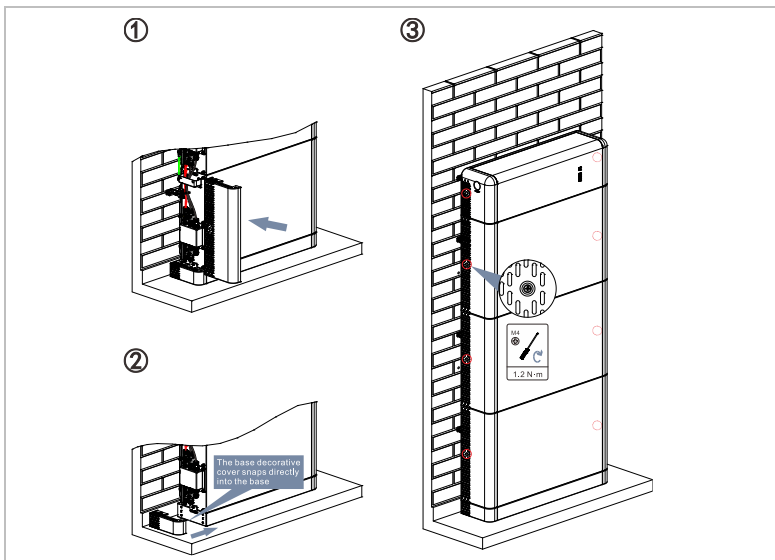

6 Commissioning the battery system

6.1 Safety check before commissioning

Ensure below points before turning the battery system on:

- The battery modules, BDU and base are all securely mounted.
- Each BAT+ /BAT- wire is firmly connected with the correct polarity, and the voltage is in the accessible range.
- The DC switch and start button of the BCU are OFF.
- Ensure that the communication cables and terminal resistors are connected correctly and securely.
- Unused terminals or connections are sealed with plugs.
- Cables are logically arranged in a tidy manner, without any damage.

6.2 Initial startup

1. Turn the DC switch of the BDU to ON.
2. Press and hold the start button of the BDU for 5 seconds, until the LED's turn on. Observe the LED indicators on the BDU to check the running status.

6.3 Setting the parameters

If the BTS battery system is connected to the SOFARSOLAR HYD inverter series, the battery parameters can be set as follows:

- 1 Enter the "Advanced Settings" menu by entering the password 0715.

- 2 According to your battery setup, set the following Battery Parameters (Battery 1 and Battery 2 if connected):
 - a. Battery type: BTS 5K
 - b. Discharge Depth
 - c. Full Charge Time

- 3 “Auto Config. Address” will detect the number and addresses of the connected batteries automatically within 2-3 Minutes.
 If the “Auto Config. Address” fails, a software update might be required on the inverter or the battery. The battery can be updated from the inverter following the below steps.

6.4 Software update

Step 1: Format a USB memory stick with FAT 32 file format, and copy all files from the firmware update Zip folder to the stick.

Attention: the files must be kept in the original folders from the Zip file, normally called “firmware” and “safety” folder in the root folder of the stick.

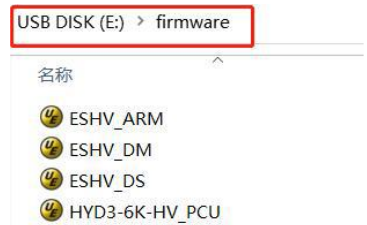

Step 2: Open USB cover and plug in USB stick

Step 3: The screen with USB icon will be displayed:



Step 4: Press Back key to enter menu, and Select “Software Update” with Enter

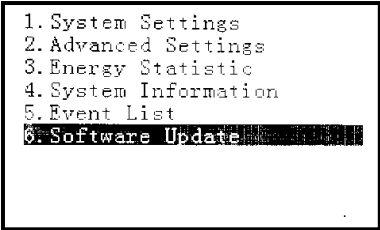

Step 5: Enter password 0715

Adjust password by up and down key for next character please press Enter

Step 6: Select the update you want to perform:

PCS HYD inverter firmware

BMS Battery management system in BTS battery

PCU DC/DC converter in BTS battery

BDU Control firmware in BDU

Software update will be performed for DSP1, DSP2 and ARM processor for the inverter (PCS).



6.5 Shutdown procedure

- 1 Press the start button for 5 seconds to turn the BDU OFF.
- 2 Turn the DC switch of the BDU to OFF. All the LED indicators on the BDU are now OFF. Before carrying out any maintenance, you should wait five minutes to ensure that the capacitor has been fully discharged.

7 Operation of the device

This chapter describes how to interpret the LED indicators of the BTS E5–E20-DS5 smart battery system.

7.1 Control panel and display field

7.1.1 Indicator lights

Below diagram shows all indicator lights on the BTS smart battery system. Please note that the LED's L1 ... L5 are counting from bottom to top:

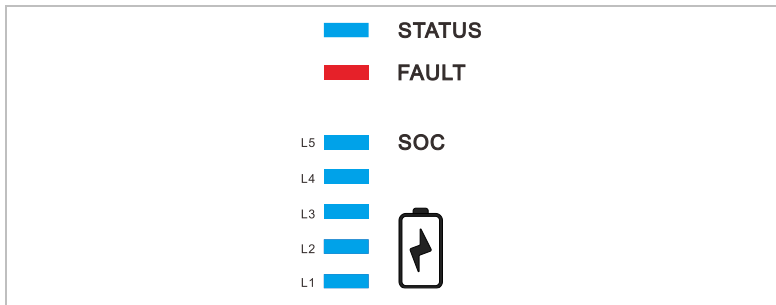

Please refer to below tables for more details.

STATUS LED	Description
Off	System is turned off
Green light flashing	Standby
Blue light flashing	Updating
Blue light on	Charging

STATUS LED	Description
Green light on	Discharging

SOC LED	Colour	Description
L1	Blue*	6...25% SOC
L2	Blue*	26...50% SOC
L3	Blue*	51...75% SOC
L4	Blue*	76...95% SOC
L5	Blue*	96...100% SOC

*flashing while charging according to the SOC, steady light when discharging

NOTE

- If the SOC goes below 6%, all lights are turned off.

In case of a fault status, the FAULT LED is flashing. In case of a fault status, the FAULT LED is on. Please refer to below table for the LED's L1 to L5 indication of each status:

SOC LED	Description
L1	High temperature
L1 + L2	Battery cell temperature differential abnormal
L1 + L2 + L3	Inverter internal fault
L1 + L2 + L3 + L4	Software version inconsistent

SOC LED	Description
L1 + L2 + L4	Terminal connection abnormal
L1 + L3	Communication fault
L1 + L3 + L4	Fuse damaged
L1 + L4	Sampling fault
L2	Low temperature
L2 + L3	Battery voltage difference too high
L2 + L4	Battery cell fault
L2 + L3 + L4	BMS internal fault
L3	Overvoltage
L4	Undervoltage
L5	Overcurrent
L3 + L4	Ambient temperature abnormal
All lights	Other alarm

8 Troubleshooting handling

8.1 Troubleshooting

This section contains information and procedures pertaining to the remedying of potential problems with the BTS smart battery system.

For specific details about the alarm and fault information displayed by the indicator lights, please refer to the paragraph 7.1. In case of an alarm or fault, an alarm report will be uploaded to the inverter. The report can then be read through the inverter display or the monitoring system.

If the BTS battery system is connected to SOFARSOLAR's HYD inverter series, the fault information can be found by entering the "Event List" in the main menu. Below list applies only to a system with a SOFARSOLAR HYD inverter series connected:

ID No.	Event Name	Solution
157	Battery 1 communication is faulty	Check whether the communication cable or port of the battery module is faulty.
158	Battery 2 communication is faulty	
159	Battery 3 communication is faulty	
160	Battery 4 communication is faulty	
177	BMS overvoltage alarm	The lithium battery is faulty. Shut down the inverter and lithium battery. Wait for 5 minutes and start the inverter and lithium battery. If the problem is not solved, contact technical support.
178	BMS undervoltage alarm	
179	BMS high temperature alarm	
180	BMS low temperature alarm	
181	BMS overcurrent alarm	
182	BMS short circuit alarm	
183	BMS version inconsistency	refer to chapter 6.4 Software update. If it doesn't solve the problem, please contact technical support.
184	BMS CAN version inconsistency	
185	BMS CAN version is too low	
801	The charging soft start failed	Restart the battery. If the problem is not solved, contact technical support.
802	The discharging soft start failed	
807	PCU version inconsistency	technical support.
808	Radiator 1 high temperature alarm	

809	The ambient temperature overheats	Turn off the system and wait for two hours. If the problem is not solved, contact technical support.
813	Charging prohibition alarm	Check the installation and the indicated faulty component. Restart the battery system. If the problem is not solved, contact technical support.
814	Discharging prohibition alarm	
815	Battery imbalance alarm	the problem is not solved, contact technical support.
928	Battery reverse polarity	
929	Fusing failure	

If the battery's indicator lights do not indicate any faulty status, please check whether the installation meets all battery operating requirements:

- Has the battery been installed in a clean, dry, well-ventilated area?
- Is the DC switch set to ON?
- Are the cables sufficiently dimensioned and short enough?
- Are the input connections, output connections and the wiring all in good condition?
- Are the configuration settings for the relevant installation correct?
- Is the communication correctly connected and undamaged?

8.2 Maintenance

Batteries do not generally require daily or routine maintenance, but the radiator should be kept free from dust, dirt, etc.

ATTENTION

- Before performing any maintenance work, turn the battery system off and wait at least 5 minutes. Ensure that the capacitor inside the battery is discharged.

8.2.1 Cleaning the battery module

Clean the battery using an air blower and a dry, soft cloth or a soft bristle brush. Do NOT clean the battery with water, corrosive chemicals, cleaning agents etc.

8.2.2 Cleaning the heat sink

In order to help guarantee correct long-term operation of the battery system, make sure that there is sufficient space for ventilation around the heat sink. Check the heat sink for blockages (dust, snow etc.) and remove them if present. Please clean the heat sink using an air blower and a dry, soft cloth or a soft bristle brush. Do NOT clean the heat sink with water, corrosive chemicals, cleaning agents etc.

8.2.3 Recharge requirements during storage

When the battery is stored for a long time, you need to perform regular maintenance. Refer to below table for the specific requirements according to each time period:

Environment temperature	Environment relative humidity	Storage time	SOC
< -10°C	/	Off limits	/
-10°C...25°C	5%...70%	≤12 months	30%...60%
25°C...35°C	5%...70%	≤6 months	30%...60%
35°C...45°C	5%...70%	≤3 months	30%...60%
> 45°C	/	Off limits	/

8.2.4 Recharge requirements during storage

Please recharge the deeply discharged (90% DOD) batteries in a timeframe in accordance with the following table, otherwise the deeply discharged battery modules will be damaged.

Environment temperature	Storage time	Note
-10°C...25°C	≤15 days	/
25°C...45°C	≤7 days	30%...60%
-10°C...45°C	≤12 hours	/

9 Manufacturer's warranty and liability terms

9.1 Warranty period

For details about the warranty period and its calculation method for SOFARSOLAR battery products, please refer to SOFARSOLAR's Warranty Agreement.

9.2 Warranty void





If equipment failure is caused by any of the below reasons, warranty shall not be covered:

- The "warranty card" has not been sent to the distributor/dealer or Shenzhen SOFARSOLAR Co., LTD.;
- Alterations made to the equipment or replacement of parts without the consent of Shenzhen SOFARSOLAR Co., LTD.;
- Failure of the product due to the use of non-qualified materials;
- Modification or attempted repair and erasure of product serial numbers or silkscreens by people other than SOFARSOLAR employees;
- Incorrect installation, commissioning and/or usage;
- Non-compliance with safety code regulations (certification standards, etc.);
- Damage caused by improper storage by the distributor or end user;
- Transport damage (including scratches caused by movement of the inner packaging during transport). Please file the claim directly with the transport company or insurance company as soon as possible,

and collect proof of the cause of damage, such as the unloading of the container/packaging;

- Failure to follow product user manuals, instructional installation manuals and maintenance guidelines;
- Improper use or misuse of the device;
- Poor ventilation of the device;
- Failure to follow product maintenance procedures in accordance with relevant standards;
- Failure or damage due to natural disasters or similar events (e.g. earthquake, lightning, fire, etc.).

10 Technical data

Datasheet	BTS E5-DS5	BTS E10-DS5	BTS E15-DS5	BTS E20-DS5
System Parameters				
System				
Battery type	LFP			
Battery distribution unit	BTS 5K-BDU			
Number of battery distribution units	1			
Battery module	BTS 5K			
Number of battery modules	1	2	3	4
Battery total energy (kWh) ¹	5.12	10.24	15.36	20.48
Usable energy (kW) ²	4.75	9.5	14.25	19
Rated power (kW)	2.5	5	7.5	10
Rated voltage (V)	400			
Voltage range for full load (V)	350 – 425			
Rated charge/discharge current (A)	7	14	21	28
Degree of protection	IP65			
Ambient temperature range ³	-10°C – 50°C			
Allowable relative humidity range	5 – 95%			
Max. operating altitude ⁴	4000 m			
Weight (kg)	59	110	161	212
Dimension (mm)	708*170*680	708*170*1100	708*170*1520	708*170*900 / 1100

Installation	Floor stand
Cooling	Natural
Display	LED indicators
Communication	CAN
Compatible inverters	Please refer to the BTS E5- 20-DS5 configuration list
Battery Module	
Model	BTS 5K
Battery module energy (kWh) ¹	5.12
Depth of discharge	90.0%
Rated power (W)	2500
Dimension (mm)	708*170*420
Weight (kg)	50
Battery Distribution Unit	
Model	BTS 5K-BDU
Max. charge/discharge current (A)	35
Dimension (mm)	708*170*200
Weight (kg)	7.5
Standard	
Certificates	UN 38.3, IEC 62619, IEC 62040-1, SAA, etc.





Shenzhen SOFARSOLAR Co., Ltd.
11/F, Gaoxingqi Technology Building,
District 67, XingDong Community, XinAn Street,
Bao'An District, Shenzhen, China

SofarSolar GmbH
Krämerstrasse 20
72764 Reutlingen
Germany

Email: service.uk@sofarsolar.com

Web: www.sofarsolar.com