



## User manual

# Solar Grid-tied Inverter

Product Model: SOFAR 3K~6KTLM-G3



---

---

## Contents

Preface.....	I
1. Basic safety information.....	1 -
1.1. Safety instructions.....	1 -
1.2. Symbols and signs.....	4 -
2. Product characteristics.....	6 -
2.1. Product dimensions.....	6 -
2.2. Function characteristics.....	8 -
2.3. Efficiency curve.....	10 -
3. Installation.....	11 -
3.1. Installation Process.....	11 -
3.2. Checking Before Installation.....	11 -
3.3. Tools.....	14 -
3.4. Determining the Installation Position.....	15 -
3.5. Moving the SOFAR 3K~6KTLM-G3.....	16 -
3.6. Installing SOFAR 3K~6KTLM-G3.....	17 -
4. Electrical Connections.....	19 -
4.1. Outlines of this chapter.....	19 -
4.2. Connecting PGND Cables.....	20 -
4.3. Connecting DC Input Power Cables.....	22 -
4.4. Connecting AC Output Power Cables.....	24 -
4.5. Com interface connection.....	27 -
4.6. WIFI/GPRS.....	33 -
5. Commissioning of inverter.....	35 -
5.1. Safety inspection before commissioning.....	35 -
5.2. Start inverter.....	35 -
6. Operation interface.....	36 -
6.1. Operation and Display Panel.....	36 -
6.2. Standard Interface.....	37 -
6.3. Main Interface.....	39 -
6.4. Update Software online.....	45 -
7. Trouble shooting.....	46 -
7.1. Trouble shooting.....	46 -
7.2. Maintenance.....	53 -
8. Technical data.....	54 -
8.1. Input parameters (DC).....	54 -
8.2. Output parameters (AC).....	55 -
8.3. Efficiency,Protection and Communication.....	56 -
8.4. General Date.....	57 -
9. Quality Assurance.....	58 -

## Notice

This manual contains important safety instructions that must be followed during installation and maintenance of the equipment.

### **Save these instructions!**

This manual must be considered as an integral part of the equipment. The manual must always accompany the equipment, even when it is transferred to another user or field.

### **Copyright Declaration**

The copyright of this manual belongs to Shenzhen SOFARSOLAR Co., Ltd. Any corporation or individual should not plagiarize, partially copy or fully copy it (including software, etc.), and no reproduction or distribution of it in any form or by any means. All rights reserved.

SOFARSOLAR reserves the right of final interpretation. This manual is subject to change according to user's or customer's feedback. Please check our website at <http://www.sofarsolar.com> for latest version.

The current Version updated at 20210414.

# *Preface*

## **Outline**

Please read the product manual carefully before installation, operation or maintenance. This manual contains important safety instructions and installation instructions that must be followed during installation and maintenance of the equipment.

## **Scope**

This product manual describes the installation, electrical connections, commissioning, maintenance and troubleshooting of SOFAR 3K~6KTLM-G3 inverters:

3KTLM-G3    3.6KTLM-G3    4KTLM-G3  
4.6KTLM-G3    5KTLM-G3    5KTLM-G3-A    6KTLM-G3





Keep this manual where it will be accessible at all times.

## **Target Group**

This manual is intended for qualified electrical technical personnel who are responsible for inverter installation and commissioning in the PV power system and PV plant operator.

## **Symbols Used**

This manual provides safety operation information and uses the symbol in order to ensure personal and property security and property security and use inverter efficiently when operating the inverter. You must understand these emphasized information to avoid the personal injury and property loss. Please read the following symbols used in this manual carefully.

	Danger indicates a hazardous situation which, if not avoided, will result in death or serious injury.
Danger	
	Warning indicates a hazardous situation which, if not avoided, could result in death or serious injury.
Warning	
	Caution indicates a hazardous situation which, if not avoided, could result in minor or moderate injury.
Caution	
	Attention indicates potential risks which, if not avoided, may lead to equipment fault or property damage.
Attention	
	Note provides tips that are valuable for the optimal operation of the product.
Note	

# *1. Basic safety information*

	If you have any question or problem when you read the following information, please contact Shenzhen SOFARSOLAR
Note	Co., Ltd.

## **Outlines of this chapter**

### **Safety instruction**

It mainly introduce the safety instruction when install and operate the equipment.

### **Symbols and signs**

It mainly introduce the safety symbols on the inverter.

## **1.1. Safety instructions**

Read and understand the instructions of this manual, and be familiar with relevant safety symbols in this chapter, then start to install and troubleshoot the equipment.

According to the national and state requirements, before connecting to the electrical grid, you must get permission from the local electrical grid operation can only be performed by qualified electrical engineer.

Please contact the nearest authorized service center if any maintenance or repair is needed. Contact your distributor for the information of the nearest authorized service center. Do NOT repair it by yourself, it may cause injury or property damage.

Before installing and maintaining the equipment, you should turn the DC switch OFF to cut off the high voltage DC of the PV array. You can also turn the switch in the PV combiner box OFF to cut off the high voltage DC. Otherwise, serious injury may be caused.

### **Qualified persons**

The customer must make sure the operator has the necessary skill and training to do his/her job. Staff in charge of using and maintaining the equipment must be skilled, aware and mature for the described tasks and must have the reliability to correctly interpret what is described in the manual. For safety reason only a qualified electrician, who has received training and / or has demonstrated skills and knowledge in construction and in operation of this unit, can install this inverter. Shenzhen SOFARSOLAR Co., Ltd does not take any responsibility for the property destruction and personal injury because of any incorrect use.

## Installation requirements

Please install inverter according to the following section. Fix the inverter on an appropriate objects with enough load bearing capacity (such as walls, PV racks etc.), and ensure that inverter is vertical placed. Choose a place suitable for installing electrical devices. And assure there is enough fire exit space, convenient for maintenance. Maintain proper ventilation to ensure enough air cycle to cool the inverter.

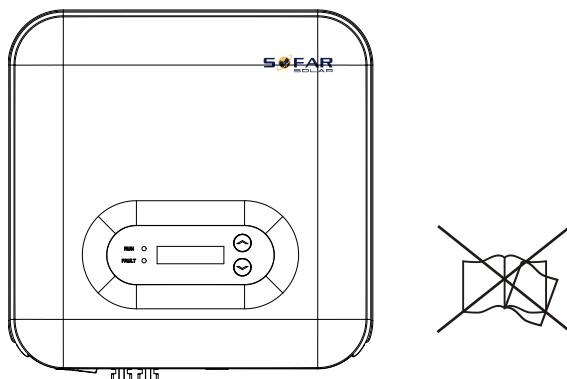





## Transport requirements

If you find packing problems that may cause the damage of the inverter, or find any visible damage, please immediately notice the responsible transportation company. You can ask solar equipment installation contractor or Shenzhen SOFARSOLAR Co.Ltd for help if necessary.



Transport of the equipment, especially by road, must be carried out with by suitable ways and means for protecting the components (in particular, the electronic components) from violent shocks, humidity, vibration, etc.

### Electric connection

Please comply with all the current electrical regulations about accident prevention in dealing with the solar invert.



	<p>Before the electrical connection, make sure to use opaque material to cover the PV modules or to disconnect PV array DC switch. Exposure to the sun, PV array will produce a dangerous voltage!</p>
<p style="background-color: red; color: white; text-align: center;">Danger</p>	<p>All installation accomplished only by professional electrical engineer! Must be trained; Completely read the manual operation and understand relevant matter.</p>
	<p>All installation accomplished only by professional electrical engineer! Must be trained; Completely read the manual operation and understand relevant matter.</p>
<p style="background-color: orange; color: white; text-align: center;">Warning</p>	<p>Get permission from the local electrical grid operator, complete all electrical connections by professional electrical engineer, then connect inverter to electrical grid.</p>
	<p>Get permission from the local electrical grid operator, complete all electrical connections by professional electrical engineer, then connect inverter to electrical grid.</p>
<p style="background-color: blue; color: white; text-align: center;">Attention</p>	<p>It's forbidden to remove the tamper evident label, or open the inverter. Otherwise Sofarsolar will not provide warranty or maintenance!</p>
	<p>It's forbidden to remove the tamper evident label, or open the inverter. Otherwise Sofarsolar will not provide warranty or maintenance!</p>
<p style="background-color: green; color: white; text-align: center;">Note</p>	

### Operation

	<p>Touching the electrical grid or the terminal of the equipment may lead to electrocution or fire! Don't touch the terminal or conductor connected to the electrical grid. Pay attention to any instructions or safety documents related to grid connection.</p>
<p style="background-color: red; color: white; text-align: center;">Danger</p>	<p>Some internal components will be very hot when inverter is working. Please wear protective gloves! Keep it away from kids !</p>
	<p>Some internal components will be very hot when inverter is working. Please wear protective gloves! Keep it away from kids !</p>
<p style="background-color: blue; color: white; text-align: center;">Attention</p>	



## Maintenance and repair



	<p>Before any repair work, turn OFF the AC circuit breaker between the inverter and electrical grid first, then turn OFF the DC switch.</p> <p>After turning OFF the AC circuit breaker and DC switch, wait for 5 minutes at least before carrying out any maintenance or repair work.</p>
<b>Danger</b>	
	<p>Inverter should work again after removing any faults. If you need any repair work, please contact with the local authorized service center.</p> <p>Can't open the internal components of inverter without authorized. Shenzhen SOFARSOLAR Co., Ltd. does not take any responsibility for the losses from that.</p>
<b>Attention</b>	

## EMC / noise level of inverter

Electromagnetic compatibility (EMC) refers to that one electrical equipment functions in a given electromagnetic environment without any trouble or error, and impose no unacceptable effect upon the environment. Therefore, EMC represents the quality characters of an electrical equipment. The inherent noise-immune character: immunity to internal electrical noise. External noise immunity: immunity to electromagnetic noise of external system. Noise emission level: influence of electromagnetic emission upon environment.









	<p><b>Electromagnetic radiation from inverter may be harmful to health!</b></p> <p>Please do not continue to stay around the inverter in less than 20 cm when inverter is working.</p>
<b>Danger</b>	

## 1.2. Symbols and signs

	<p>Caution of burn injuries due to hot enclosure!</p> <p>You can only touch the screen and pressing key of the inverter while it's working.</p>
<b>Caution</b>	
	<p>PV array should be grounded in accordance to the requirements of the local electrical grid operator!</p> <p>We suggest that all PV module frames and inverter are reliably grounded to protect the PV system and personnel security.</p>
<b>Attention</b>	
	<p>Ensure input DC voltage &lt; Max. DC voltage .Over voltage may cause permanent damage to inverter or other losses, which will not be included in warranty!</p>
<b>Warning</b>	

## Signs on the inverter

There are some symbols which are related to security on the inverter. Please read and understand the content of the symbols, and then start the installation.

	<p>There is a residual voltage in the inverter! Before opening the equipment, operator should wait for five minutes to ensure the capacitor is discharged completely.</p>
	<p>Caution, risk of electric shock.</p>
	<p>Caution hot surface.</p>
	<p>Comply with the Conformite Europeenne (CE) certification.</p>
	<p>Grounding point.</p>
	<p>Please read this manual before install SOFAR 3K~6KTLM-G3.</p>
	<p>This indicates the degree of protection of the equipment according to IEC standard 70-1 (EN 60529 June 1997).</p>
	<p>Positive pole and negative pole of the input voltage (DC).</p>
	<p>RCM (Regulatory Compliance Mark) The product complies with the requirements of the applicable Australian standards.</p>

## 2. Product characteristics

### Outlines of this chapter

#### Product dimensions

It introduces the field of use, and the overall dimensions of SOFAR 3K~6KTLM-G3 inverters.

#### Function description

It introduces how SOFAR 3K~6KTLM-G3 inverters work and the function modules inside.

#### Efficiency curves

It introduces the efficiency curves of in the inverter.

### 2.1. Product dimensions

SOFAR 3K~6KTLM-G3 is a dual MPPT grid-tied PV inverter which converts the DC power generated by PV arrays into sine wave single-phase AC power and feeds it to the public electrical grid, AC circuit breaker (refer to Section 4.4) and DC switch used as disconnect device, and the disconnect device shall be easily accessible.

Figure2-1 PV Grid-tied System

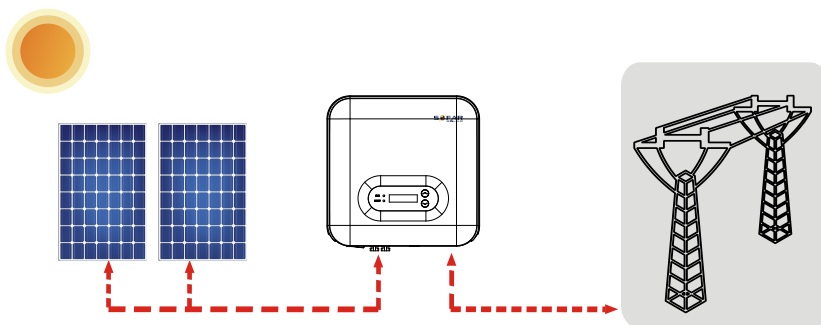

SOFAR 3K~6KTLM-G3 inverters can only be used with photovoltaic

modules that do not require one of the poles to be grounded. The operating current during normal operation must not exceed the limits specified in the technical specifications. Only the photovoltaic modules can be connected to the input of the inverter (do not connect batteries or other sources of power supply).

The choice of optional parts of inverter should be made by a qualified technician who knows the installation conditions clearly.

Overall dimensions:L×W×H=349mm×344mm×164mm

Figure 2-2 Front view and left view dimensions of SOFAR 3K~6KTLM-G3

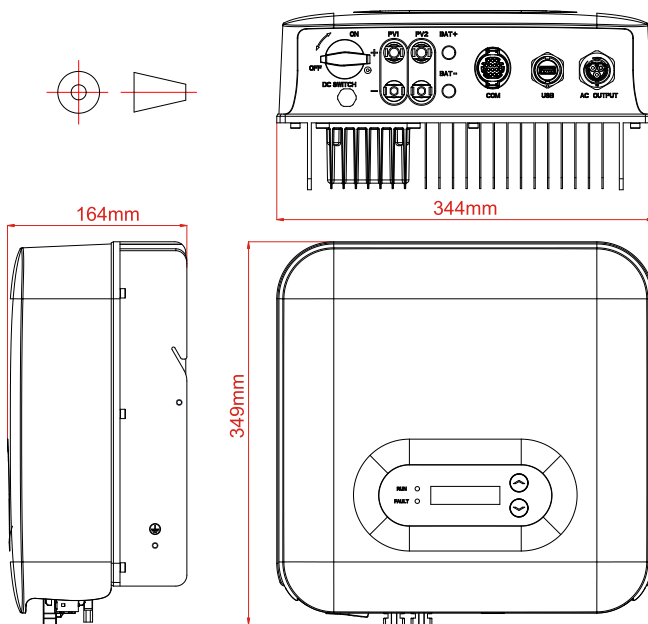
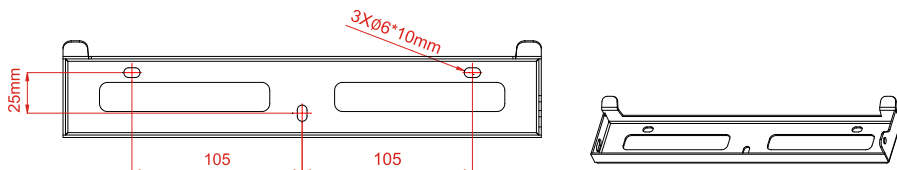
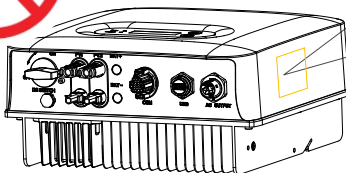



Figure 2-3 Bracket dimensions of SOFAR 3K~6KTL-G3



◆ Labels on the equipment

The labels must NOT be hidden with objects and extraneous parts (rags, boxes, equipment, etc.); they must be cleaned regularly and kept visible at all times.



SOFAR Solar Grid-tied Inverter	
Model No.	SOFAR 6KTLM-G3
Max. DC Operating Voltage	600V
Operating MPPT Voltage Range	80~570V
Max. Input Current	24.0A
Max. P.V. DC	24.0A
Nominal Grid Voltage	230V
Max. Output Current	23A
Nominal Grid Frequency	50/60Hz
Nominal Output Power	6000W
Max. Output Power	6000VA
Power Factor	1.00@0.95~0.99
Ingress Protection	IP65
Operating Temperature Range	-30°C~+65°C
Protection Class	Class I
Inverter Topology	Non-Isolated
Manufacturer	Shenzhen SOFAR SOLAR CO., LTD
Address	#01, Building 4, An'angya Industrial Park, Qianhai 4th, Kongsing Community, Shenzhen, Shenzhen District, Shenzhen, China
SALES OFFICE	VOICENTRA 1-1, 1009 2904048, AS4777
	852-2516-8517/77
	

## 2.2. Function characteristics

DC power generated by PV array is filtered through Input Board before entering into Power Board. Input Board also offer functions such as insulation impedance detection and input DC voltage / current detection. DC power is converted to AC power by Power Board. AC power is filtered through Output Board then AC power is fed into the grid. Output Board also offer functions such as grid voltage / output current detection, GFCI and output isolation relay. Control Board provides the auxiliary power, controls the operation state of inverter and shows the operation status by Display Board. Display Board displays fault code when inverter is in abnormal operation conditions. At the same time, Control Board can trigger the relay so as to protect the internal components.

### Function module

#### A. Energy management unit

This control can be used to switch the inverter on/off through an external (remote) control.

#### B. Feeding reactive power into the grid

The inverter is able to produce reactive power and can therefore feed it into the grid through the setting of the phase shift factor. Feed-in management can be controlled directly by the grid company through a dedicated RS485 serial interface.

### C. Limiting the active power fed into the grid

The inverter, if enabled can limit the amount of active power fed into the grid by the inverter to the desired value (Expressed as a percentage).

### D. Self power reduction when grid is over frequency

When the grid frequency is higher than the limited value, inverter will reduce output power which is necessary for the grid stability.

### E. Data transmission

The inverter or a group of inverters may be monitored remotely through an advanced communication system based on RS-485 serial interface, or remotely via the WIFI/GPRS.

### F. Software update

Support usb flash drive local upgrade software and WIFI/GPRS remote upgrade software.

## Electrical block diagram

Figure2-4 Electrical block diagram

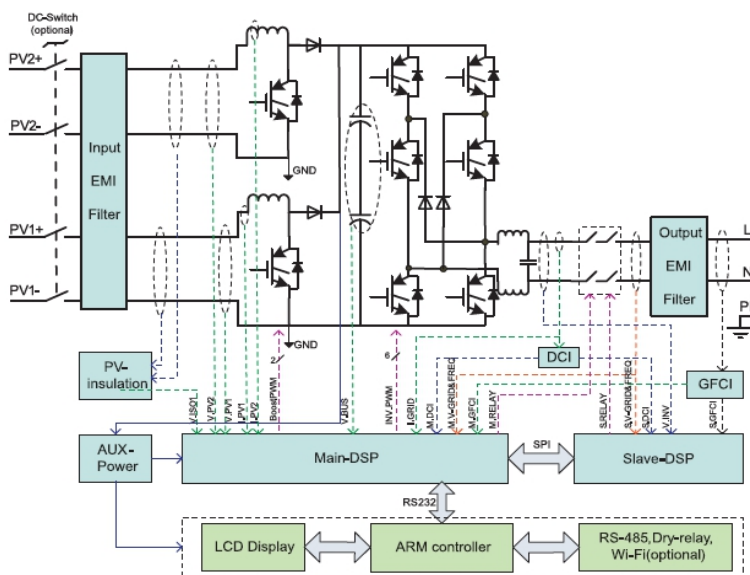

## 2.3. Efficiency curve

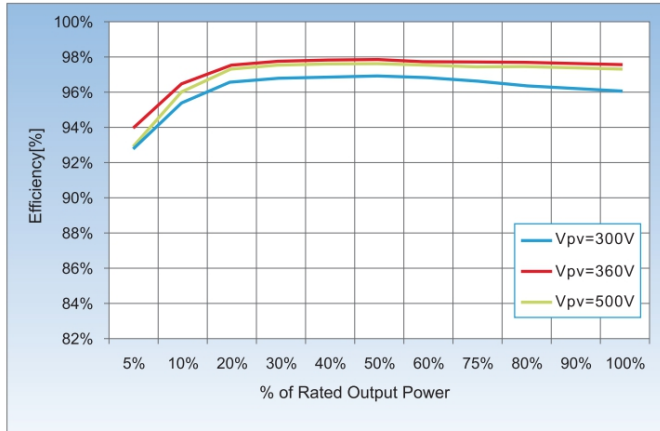



# 3. Installation

## Outlines of this chapter

This topic describes how to install the SOFAR 3K~6KTLM-G3 .

### Installation notes

 <b>Danger</b>	<p>Do NOT install the SOFAR 3K~6KTLM-G3 on flammable material.</p> <p>Do NOT install the SOFAR 3K~6KTLM-G3 in an area used to store Flammable or explosive material.</p>
 <b>Caution</b>	<p>The enclosure and heat sink are very hot while the inverter is working, therefore do NOT install the SOFAR 3K~6KTLM-G3 in places where you might touch them inadvertently.</p>
 <b>Attention</b>	<p>Consider the weight of SOFAR 3K~6KTLM-G3 when transporting and moving the inverters.</p> <p>Choose an appropriate mounting position and surface.</p> <p>Assign at least two persons to install the inverter.</p>

## 3.1. Installation Process

Figure 3-1 Installation flowchart

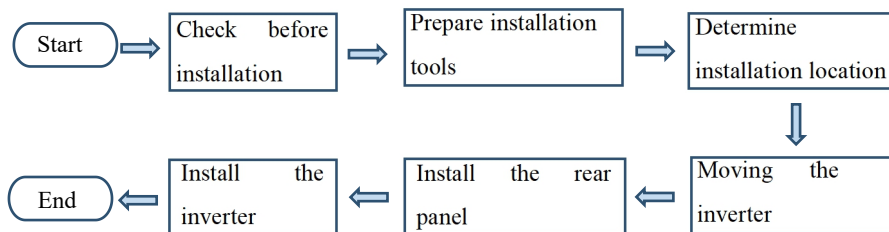

## 3.2. Checking Before Installation

### Checking Outer Packing Materials

Packing materials and components may be damaged during transportation.







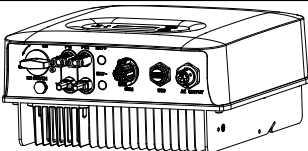
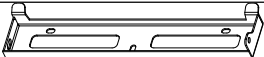
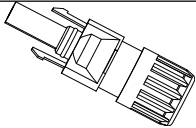
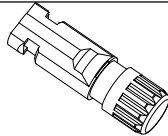
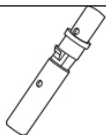

Therefore, check the outer packing materials before installing the inverter. Check the outer packing materials for damage, such as holes and cracks. If any damage is found, do not unpack the SOFAR 3K~6KTLM-G3 and contact the dealer as soon as possible. You are advised to remove the packing materials within 24 hours before installing the SOFAR 3K~6KTLM-G3 inverter.

### Checking Deliverables

After unpacking the inverter, check whether deliverables are intact and complete. If any damage is found or any component is missing, contact the dealer.

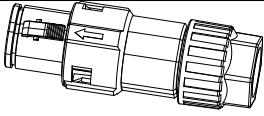
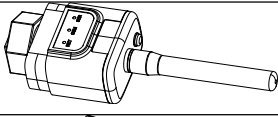
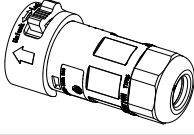
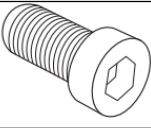
Table3-1 Shows the components and mechanical parts that should be delivered.

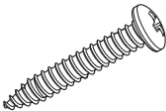

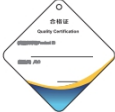



NO.	Picture	Description	Quantity
1		3K~6KTLM-G3	1pcs
2		Rear panel	1pcs
3		PV+ input terminal	2pcs
4		PV- input terminal	2pcs
5		Metal terminals secured to PV+ input power cables	2pcs
6		Metal terminals secured to PV- input power cables	2pcs

7		COM 16pin Communication Terminal	1pcs
8		USB acquisition stick (WIFI/GPRS/Ethernet)	1pcs (Optional)
9		AC output terminal	1pcs
10		M6 Hexagon screws	2pcs
11		Expansion bolts	3pcs
12		Self-tapping screw	3pcs
13		Manual	1pcs
14		The warranty card	1pcs
15		Registration Form	1pcs

### 3.3. Tools

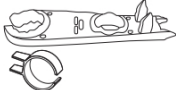
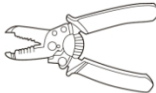
Prepare tools required for installation and electrical connections.

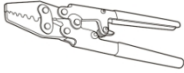
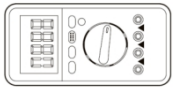
Table 3-2 Shows the tools required for installation and electrical connections.

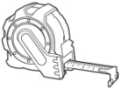
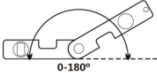
NO.	Tool	Model	Function
1		Hammer drill Recommend drill dia. 6mm	Used to drill holes on the wall.
2		Screwdriver	Wiring
3		Cross screwdriver	Remove and install AC terminal screws
4		Removal tool	Remove PV terminal
5		Wire stripper	Strip wire
6		5mm Allen Wrench	Turn the screw to connect rear panel with inverter.
7		Crimping tool	Used to crimp power cables
8		Multi-meter	Used to check grounding
9		Marker	Used to mark signs
10		Measuring tape	Used to measure distances
11		Level	Used to ensure that the rear panel is properly installed

12		ESD gloves	Operators wear
13		Safety goggles	Operators wear
14		Anti-dust respirator	Operators wear

### 3.4. Determining the Installation Position

Determine an appropriate position for installing the SOFAR 3K~6KTLM-G3 inverter. Comply with the following requirements when determining the installation position:

Figure3-2 Installation Requirements

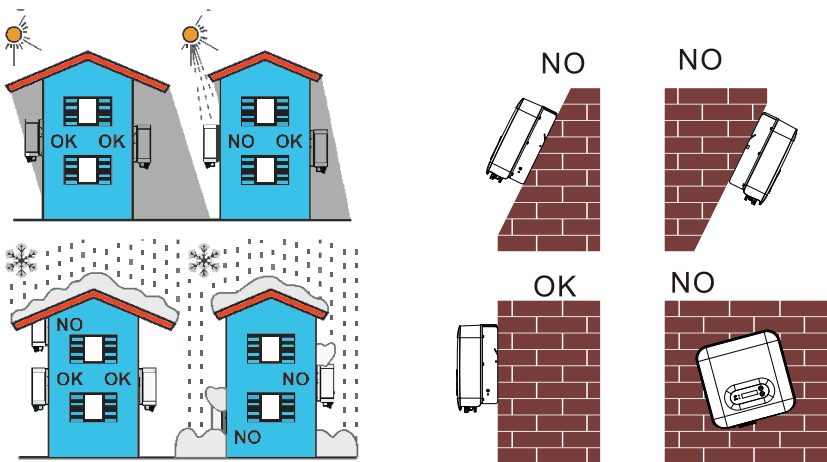

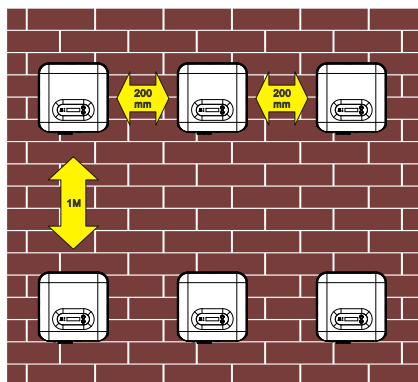
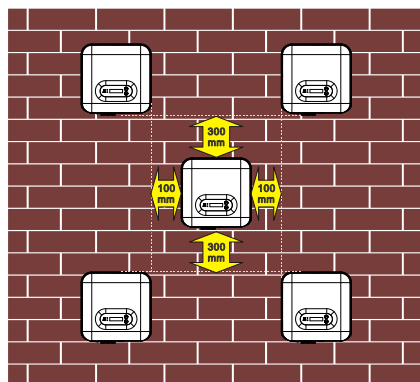
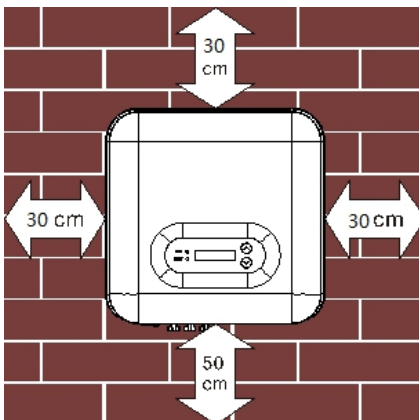
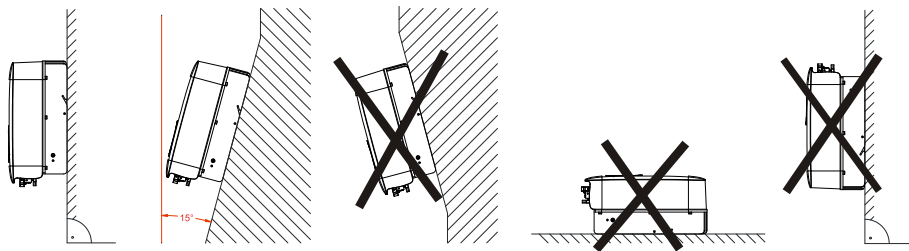

### 3.5. Moving the SOFAR 3K~6KTLM-G3

This topic describes how to move the to the installation position  
Horizontally SOFAR 3K~6KTLM-G3.

**Step 1** Open the packaging, insert hands into the slots on both sides of the inverter and hold the handles, as shown in Figure 3-3 and Figure 3-4.

Figure 3-3 Moving the inverter (1)

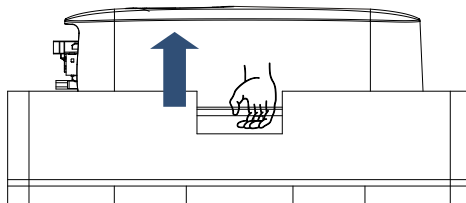
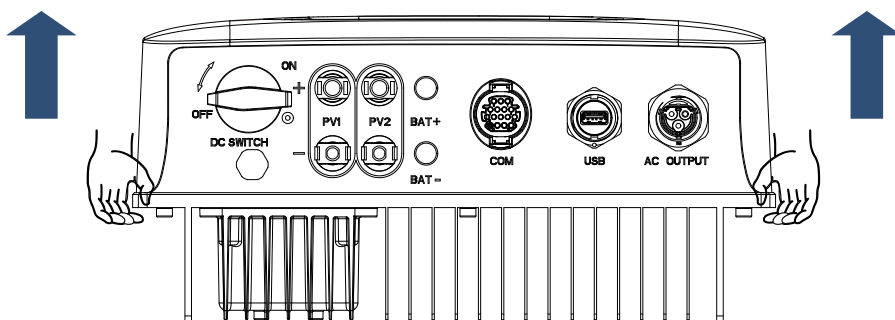



Figure 3-4 Moving the inverter (2)



**Step 2** Lift the SOFAR 3K~6KTLM-G3 from the packing case and move it to the installation position.

 <p><b>Attention</b></p>	<p>To prevent device damage and personal injury, keep balance when moving the inverter because the inverter is heavy.</p> <p>Do not put the inverter with its wiring terminals contacting the floor because the power ports and signal ports are not designed to support the weight of the inverter. Place the inverter horizontally.</p> <p>When placing the inverter on the floor, put foam or paper under the inverter to protect its shell.</p>
---	---

### 3.6. Installing SOFAR 3K~6KTLM-G3

**Step 1** Determine the positions for drilling holes, ensure the hole positions are level, then mark the hole positions using a marker pen, use the hammer drill to drill holes on the wall. Keep the hammer drill perpendicular to the wall, do not shake when drilling, so as not to damage the wall. If the error of the hole

positions is too big, you need to reposition.

**Step 2** Insert the expansion bolt vertically into the hole, pay attention to the insertion depth of the expanding bolt (should be deep enough).

**Step 3** Align the rear panel with hole positions, fix the rear panel on the wall by tightening the expansion bolt with the nuts.

Figure 3-5

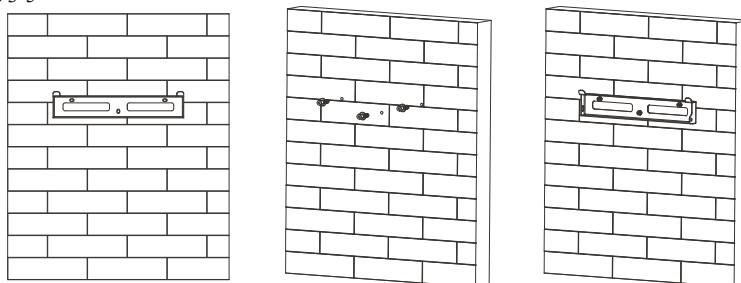

**Step 4** Hook the inverter to the rear panel. Using an M6 screw to secure the inverter to the rear panel to ensure safety.

**Step 5** You can secure the inverter to the rear panel and protect it from stealing by installing an anti-theft lock (this action is optional).

Figure 3-6

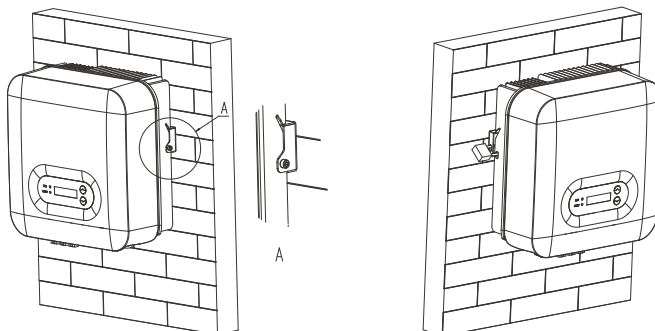



## 4. Electrical Connections

### 4.1. Outlines of this chapter

This topic describes the SOFAR 3K~6KTLM-G3 inverter electrical connections. Read this part carefully before connecting cables.

**NOTE:** Before performing electrical connections, ensure that the DC switch is OFF. Since the stored electrical charge remains in a capacitor after the DC switch is turned OFF. So it's necessary to wait for at least 5 minutes for the capacitor to be electrically discharged.

	Installation and maintenance of inverter, must be operated by professional electrical engineer.
<b>Attention</b>	
	PV modules generate electric energy when exposed to sunlight and can create an electrical shock hazard. Therefore, before connecting DC input power cable, cover PV modules using opaque cloth
<b>Danger</b>	
	For SOFAR 3K~6KTLM-G3, open-circuit voltage(Voc) of module arrays connected in series must be $\leq 550V$ .
<b>Note</b>	

The connected PV modules must have an IEC 61730 Class A rating

IscPV(absolute maximum)	22.5A/22.5A	
Maximum output over current protection	SOFAR 3KTLM-G3	15A
	SOFAR 3.6KTLM-G3	16A
	SOFAR 4KTLM-G3	20A
	SOFAR 4.6KTLM-G3	23A
	SOFAR 5KTLM-G3	25A
	SOFAR 5KTLM-G3-A	21.7A
	SOFAR 6KTLM-G3	29A

The decisive voltage class(DVC)

**NOTE:** The DVC is the voltage of a circuit which occurs continuously between any



two live part in the worst-case rated operating condition when used as intended.

Interface	DVC
PV input interface	DVCC
AC output interface	DVCC
USB interface	DVCA
Com interface	DVCA

## PV terminal and DC switch parameters

PV terminal		DC switch	
Rated insulation voltage	1000V	Rated insulation voltage	800V
Rated operational current	39A	Rated impulse withstand voltage	8KV
Protection class	IP68	Rated operational current	25A
Maximum temperature limit	105°C	Icw	700A 1S
		Icm	4xle
		Ithe	50A

## 4.2. Connecting PGND Cables

Connect the inverter to the grounding electrode using protection ground (PGND) cables for grounding purpose.

	<p>The inverter is transformer-less, requires the positive pole and negative pole of the PV array are NOT grounded. Otherwise it will cause inverter failure. In the PV power system, all non current carrying metal parts (such as: PV module frame, PV rack, combiner box enclosure, inverter enclosure) should be connected to earth.</p>
Attention	

### Prerequisites:

The PGND cables are prepared (  $\geq 4\text{mm}^2$  outdoor power cables are recommended for grounding purposes),the color of cable should be yellow-green.

### Procedure:

**Step 1** Remove the insulation layer with an appropriate length using a wire

stripper, as shown in Figure 4-1.

Figure4-1 Preparing a ground cable (1)

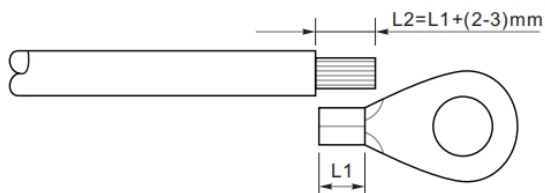

**Note:** L2 is 2 to 3mm longer than L1

**Step 2** Insert the exposed core wires into the OT terminal and crimp them by using a crimping tool, as shown in Figure 4-2.

Figure4-2 Preparing a ground cable (2)

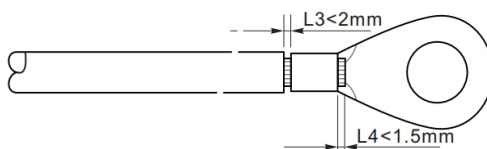

**Note 1:** L3 is the length between the insulation layer of the ground cable and the crimped part. L4 is the distance between the crimped part and core wires protruding from the crimped part.

**Note 2:** The cavity formed after crimping the conductor crimp strip shall wrap the core wires completely. The core wires shall contact the terminal closely.

**Step 3** Install the crimped OT terminal, flat washer using M6 screw, and tighten the screw to a torque of 6 N.m using an Allen wrench.

Figure4-3 Ground terminal composition

1. Tapped hole
2. OT Terminal
3. M6 screw

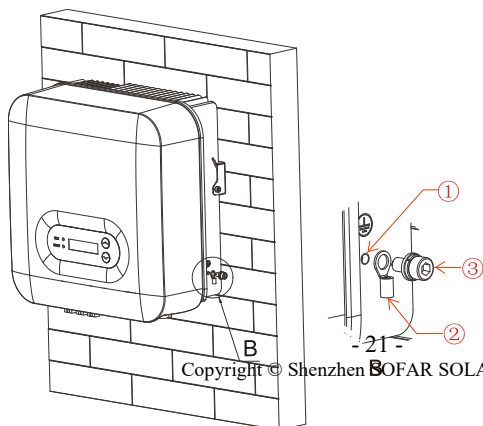

## 4.3. Connecting DC Input Power Cables

Table 4-1 Recommended DC input cable specifications

Cross-Sectional Area (mm <sup>2</sup> )		External Cable Diameter(mm)
Range	Recommended Value	
4.0~6.0	4.0	4.5~7.8

**Step 1** Remove cable glands from the positive and negative connectors.

**Step 2** Remove the insulation layer with an appropriate length from the positive and negative power cables by using a wire stripper as show in Figure 4-4.

Figure 4-4 Connecting DC input power cables

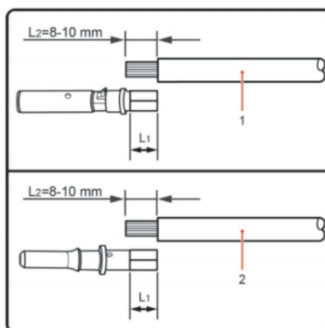

1.Positive power cable 2.Negative power cable

**Note:** L2 is 2 to 3 mm longer than L1.

**Step 3** Insert the positive and negative power cables into corresponding cable glands.

**Step 4** Insert the stripped positive and negative power cables into the positive and negative metal terminals respectively and crimp them using a clamping tool. Ensure that the cables are crimped until they cannot be pulled out by force less than 400 N, as shown in Figure 4-5.

Figure 4-5 Connecting DC input power cables

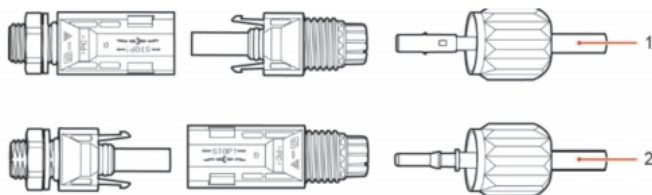

1.Positive power cable 2.Negative power cable

**Step 5** Insert crimped power cables into corresponding housings until you hear a "click" sound. The power cables snap into place.

**Step 6** Reinstall cable glands on positive and negative connectors and rotate them against the insulation covers.

**Step 7** Insert the positive and negative connectors into corresponding DC input terminals of the inverter until you hear a "click" sound, as shown in Figure 4-6.

Figure 4-6 Connecting DC input power cables

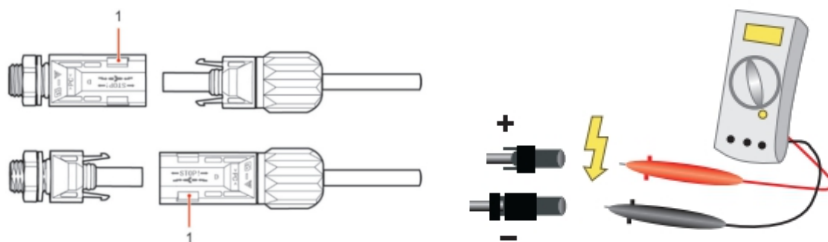

1.Bayonet

**Note:** Please use the multimeter to confirm the positive and negative poles of the photovoltaic array!

**Follow-up Procedure**

To remove the positive and negative connectors from the inverter, insert a removal wrench into the bayonet and press the wrench with an appropriate strength, as shown in Figure 4-7.

	<p>Before removing the positive and negative connectors, ensure that the DC SWITCH is OFF.</p>
<p><b>Caution</b></p>	

Figure 4-7 Removing a DC input connector

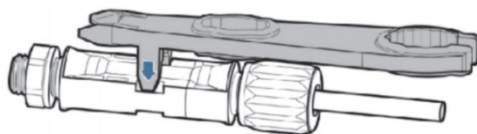

## 4.4. Connecting AC Output Power Cables

Connect the SOFAR 3K~6KTLM-G3 to the AC power distribution frame or power grid using AC output power cables.

	It is not allowed for several inverters to use the same circuit breaker. It is not allowed to connect loads between inverter and circuit breaker.
<b>Caution</b>	AC breaker used as disconnect device, and the disconnect device shall remain readily operable.

### Context

All the AC output cables used for the inverters are outdoor three-core cables. To facilitate the installation, use flexible cables. Table 4-2 lists the recommended specifications for the cables.

Figure 4-8 NOT allowed: connect loads between inverter and circuit breaker

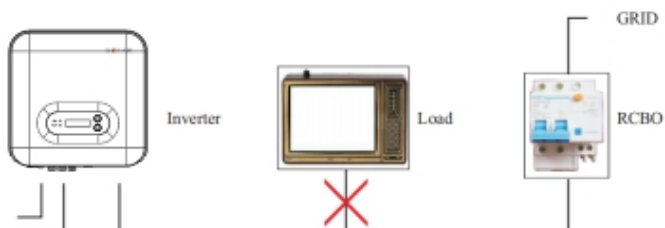
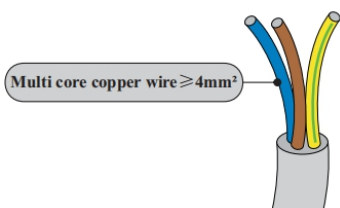

Table4-2 Recommended AC output cable specifications

Model	3KTLM-G3	3.6KTL-M-G3	4KTLM-G3	4.6KTLM-G3	5KTLM-G3	5KTLM-G3-A	6KTLM-G3
Cable (Copper)	≧6mm <sup>2</sup>	≧6mm <sup>2</sup>	≧6mm <sup>2</sup>	≧10mm <sup>2</sup>	≧10mm <sup>2</sup>	≧10mm <sup>2</sup>	≧10mm <sup>2</sup>
Breaker	20A	25A	25A	32A	32A	32A	32A

### Multi core copper wire



AC cable should be correctly sized to ensure the power loss in AC cable is less than 1% of the rated power. If the resistance of the AC cable is too high, it will cause a huge increase in the AC voltage, which may lead to a disconnection of the inverter from the

electrical grid. The relationship between power loss in AC cable and wire length, wire cross sectional area is shown in the following figure:

Figure 4-9 Wire length, wire cross sectional area and wire power loss

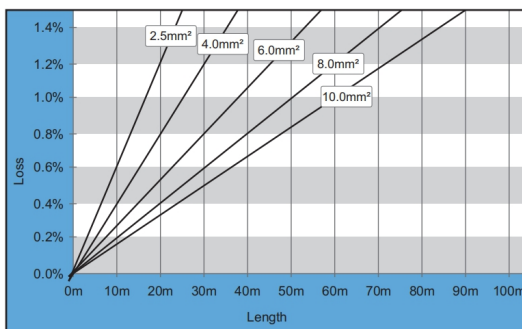

Inverter is equipped with IP66 AC connector, and the AC output cable needs to be wired by the customer. The appearance of AC connector is shown in figure 4-10.

Figure 4-10 AC connector

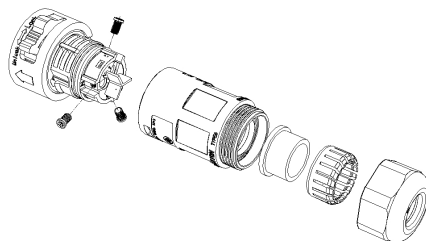

**Step 1** Select appropriate cables according to Table 4-2, Remove the insulation layer of the AC output cable using a wire stripper according to the figure shown below:

A:15-25mm B:6~8mm

**Step 2** Disassemble the AC connector according to the figure shown below: insert the AC output cable (with its insulation layer stripped according to step 1) through the waterproof locking cable gland.

**Step 3** Connect AC output cable as per the following requirements:

Connect the yellow-green wire to the hole labeled "PE", fasten the wire using a Cross screwdriver;

Connect the brown wire to the hole labeled "L", fasten the wire using a Cross screwdriver;

Connect the blue wire to the hole labeled "N", fasten the wire using a Cross screwdriver.

**Step 4** Insert the AC connector and hear "click", then tighten the waterproof nut at the instantaneous value, as shown in the figure below, to ensure that the cable is firmly connected.

Figure 4-11

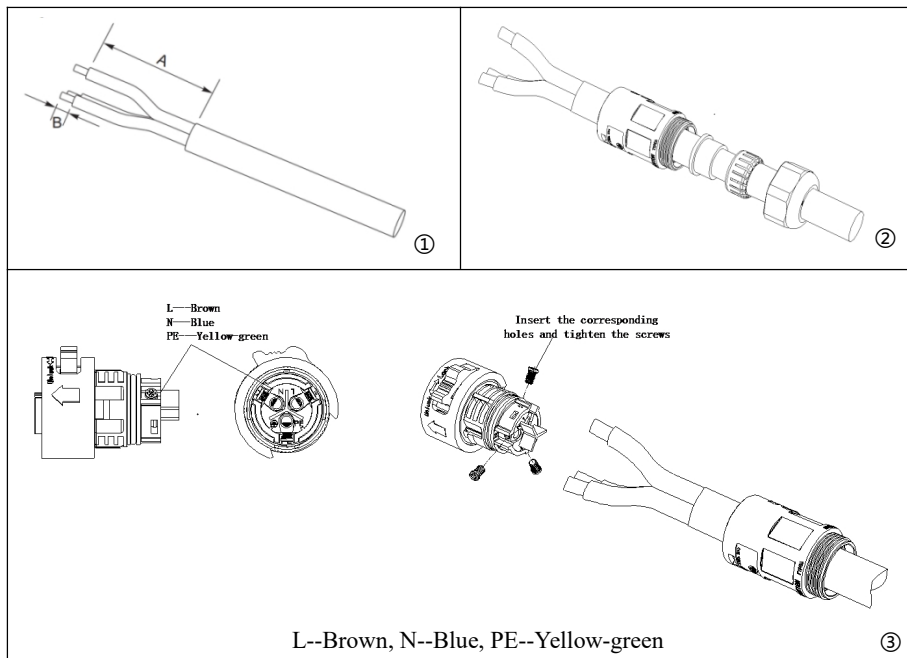

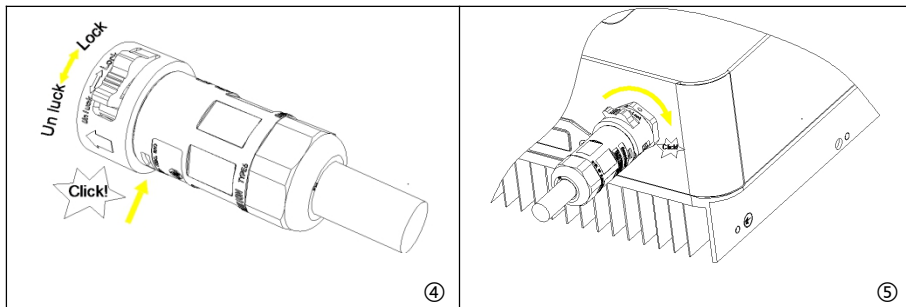

**Removing the AC connector** Hold the button to unlock and rotate the knob counterclockwise to the unlock position, then pull out the AC connector.

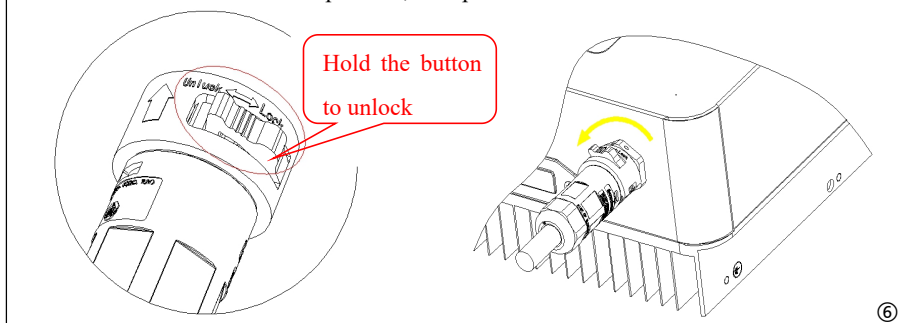

Caution

Make sure the grid is disconnected before removing the AC connector.

## 4.5. Com interface connection

The com interface location of the SOFAR 3K~6KTLM-G3 is shown in the figure below.

Figure 4-12



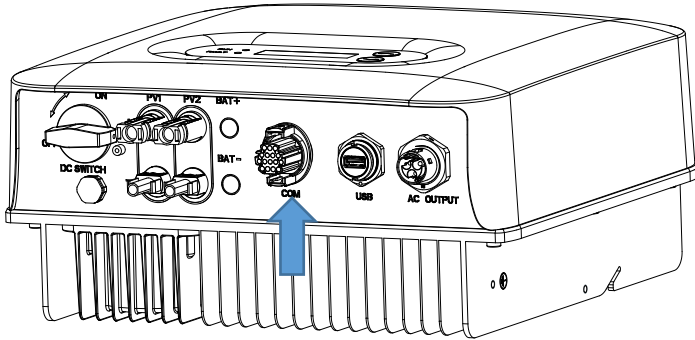

Figure 4-13 COM interface

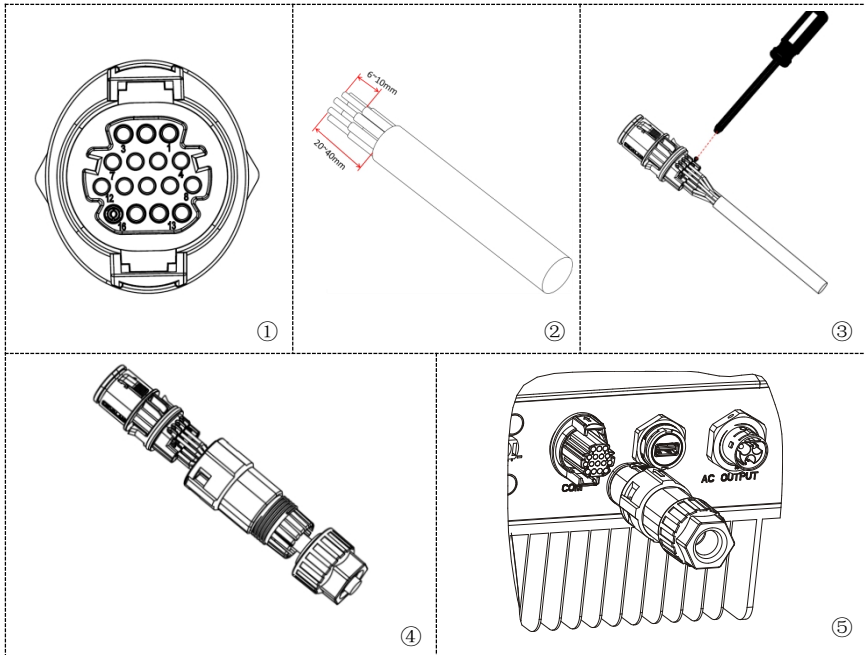

Table 4-3 Com interface

PIN	Definition	Function	Note
1	485_TX+	RS485 differential signal +	Wired monitoring or inverter cascade monitoring
2	RS485-B	RS485 differential signal +	Meter communication
3	485_TX-	RS485 differential signal -	Wired monitoring or inverter cascade monitoring
4	RS485-A	RS485 differential signal -	Meter communication
5	CT+	The current sensor outputs a positive electrode	Used to connect current sensor of power grid
6	CT-	The current sensor outputs a negative electrode	
7~10	NC	/	/
11	DRM0	The logic interface pin definitions and circuit connections are as follows: Logic interface pin are defined according to different standard requirements	
12	GND		
13	DRM8		
14	DRM7		
15	DRM6		
16	DRM5		

#### 4.4.1 Logic interface

(a) Logic interface for AS/NZS 4777.2:2015, also known as inverter demand response modes (DRMs).

The inverter will detect and initiate a response to all supported demand response commands within 2 s. The inverter will continue to respond while the mode remains asserted.

Table 4-3 Function description of the DRMs terminal

Pin NO.	Function
16	DRM1/5
15	DRM2/6
14	DRM3/7
13	DRM4/8
12	GND
11	DRM0

NOTE: Supported DRM command: DRM0, DRM5, DRM6, DRM7, DRM8.

(b) Logic interface for VDE-AR-N 4105:2018-11, is in order to control and/or limit the inverter's output power.

The inverter can be connected to a RRCR (Radio Ripple Control Receiver) in order to dynamically limit the output power of all the inverters in the

installation.

Figure 4-14 Inverter – RRCR Connection

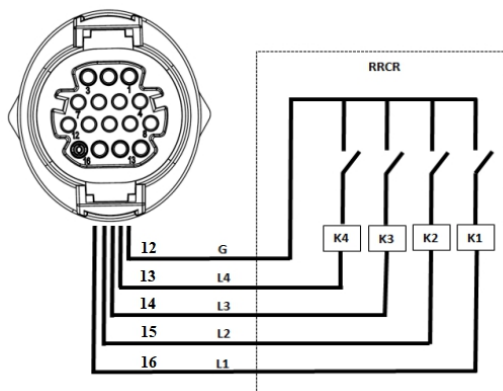

Table 4-4 Function description of the terminal

Pin NO.	Pin name	Description	Connected to (RRCR)
16	L1	Relay contact 1 input	K1 - Relay 1 output
15	L2	Relay contact 2 input	K2 - Relay 2 output
14	L3	Relay contact 3 input	K3 - Relay 3 output
13	L4	Relay contact 4 input	K4 - Relay 4 output
12	G	GND	Relays common node

Table 4-5 The inverter is preconfigured to the following RRCR power levels

Relay status: close is 1, open is 0

L1	L2	L3	L4	Active Power	Cos( $\varphi$ )
1	0	0	0	0%	1
0	1	0	0	30%	1
0	0	1	0	60%	1
0	0	0	1	100%	1

(c) Logic interface for EN50549-1:2019, is in order to cease active power output within five seconds following an instruction being received at the input interface.

Figure 4-15 Inverter – RRCR Connection

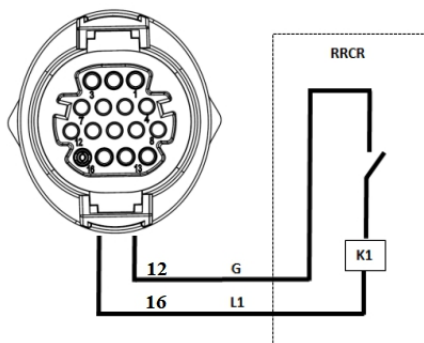

Table 4-6 Function description of the terminal

Pin NO.	Pin name	Description	Connected to (RRCR)
16	L1	Relay contact 1 input	K1 - Relay 1 output
12	G	GND	K1 - Relay 1 output

Table 4-7 The inverter is preconfigured to the following RRCR power levels.

Relay status: close is 1, open is 0

L1	Active Power	Power drop rate	Cos( $\varphi$ )
1	0%	<5 seconds	1
0	100%	/	1

**Step4** Insert the terminal as per the printed label, and then tighten the screws to fix the waterproof cover, rotate the cable gland clockwise to fasten it securely.

#### 4.4.2 RS485 interface

By RS485 interface, transfer the inverter power output information, alarm information, operation state to the PC terminal or local data acquisition device, then uploaded to the server.

If only one SOFAR 3K~6KTLM-G3 is used, use a communication cable, refer to section 4.5.2 for COM pin definition, and select RS485 port to connect.

Figure 4-16 A single SOFAR 3K~6KTLM-G3 connecting communications

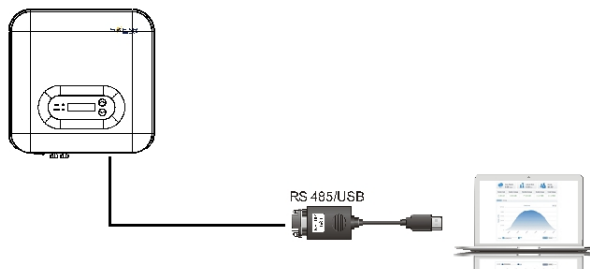

If multiple SOFAR 3K~6KTLM-G3 are used, connect all SOFAR 3K~6KTLM-G3 in daisy chain mode over the RS485 communication cable. Set different Modbus address (1~31) for each inverter in LCD display.

Figure 4-17 Multi SOFAR 3K~6KTLM-G3 connecting Communications

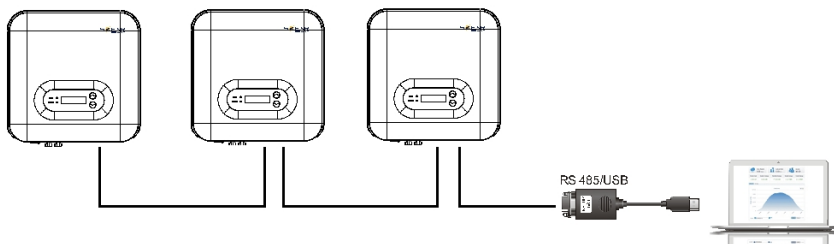

### 4.4.3 CT interface

Figure 4-18

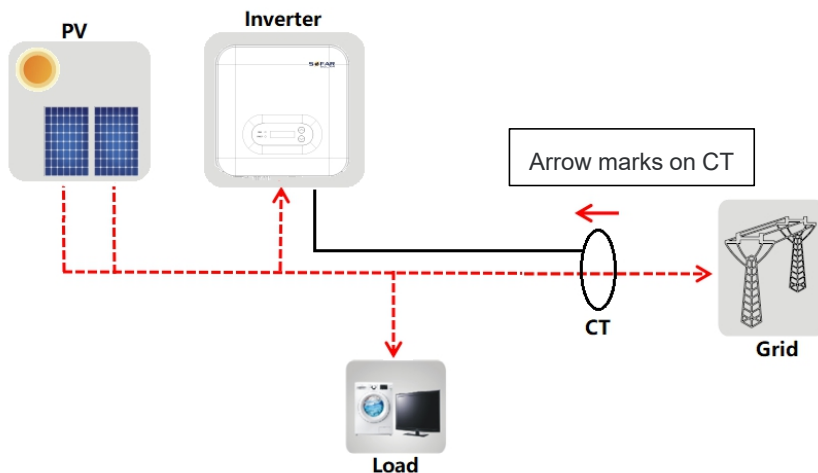

## 4.6. WIFI/GPRS

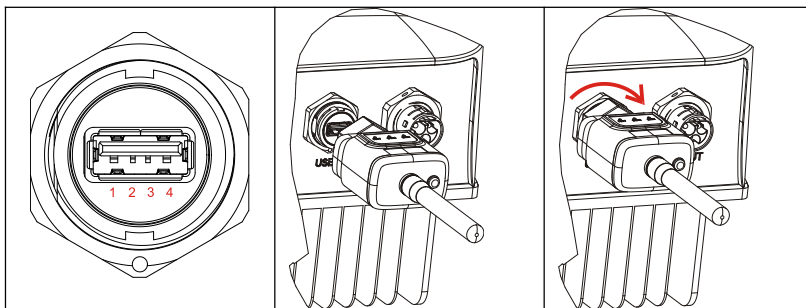

Figure 4-19 Connect one USB acquisition stick (WIFI version) to wireless router

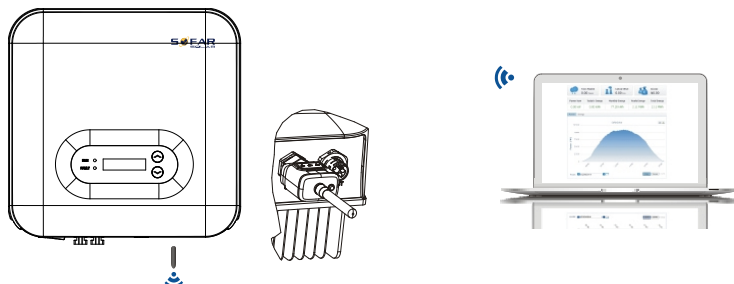
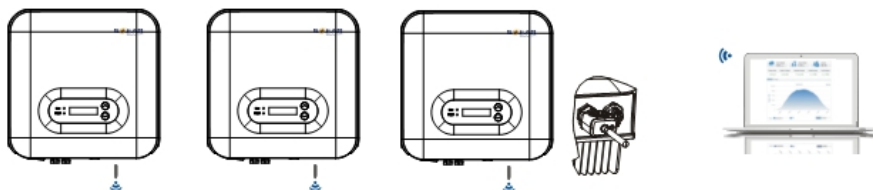

Figure 4-20 Connect multiple USB acquisition stick (WIFI version) to wireless router



### NOTE

The length of the RS485 communication cable should be less than 1000 m.

The length of the WIFI communication cable should be less than 100 m.

If multiple SOFAR 3K~6KTLM-G3 are connected to the monitoring device over an RS485/USB converter, a maximum of 31 inverters can be connected in a daisy chain.

The operation information (generated energy, alert, operation status) of the inverter can be transferred to PC or uploaded to the server via WiFi/GPRS. Users can choose to use web or APP for monitoring and viewing according to their needs. They need to register an account and bind the device with the WiFi/GPRS SN number. The SN number of the WiFi/GPRS shall be affixed to the package box and the WiFi/GPRS.

Web: <https://home.solarmanpv.com> (Recommended browser: Chrome58、Firefox49、IE9 and above version) .

APP: Android: Go to Android Market and search “SolarMAN”.

IOS: Go to App Store and search “SolarMAN”.

SolarMAN-3.0-Web User Manual, Please visit the

<https://doc.solarmanpv.com/web/#/7>.

SolarMAN-App User Manual, Please visit the <https://doc.solarmanpv.com/web/#/14>.

## 5. Commissioning of inverter

### 5.1. Safety inspection before commissioning

**Attention**

Ensure that DC and AC voltages are within the acceptable range of the inverter.

### 5.2. Start inverter

**Step 1:** Turn ON the DC switch.(optional)

**Step 2:** Turn ON the AC circuit breaker.

When the DC power generated by the solar array is adequate, the SOFAR 3K~6KTLM-G3 inverter will start automatically. Screen showing “normal” indicates correct operation.

**NOTE:** Choose the correct country code. (refer to section 6.3 of this manual)

**Notice:** Different distribution network operators in different countries have different requirements regarding grid connections of PV grid connected inverters.

Therefore, it's very important to make sure that you have selected the correct country code according to requirements of local authority. Please consult qualified electrical engineer or personnel from electrical safety authorities about this.

Detection methods of isolated islands:ROCOF.

Shenzhen SOFAR SOLAR Co., Ltd. is not responsible for any consequences arising out of incorrect country code selection.

If the inverter indicates any fault, please refer to Section 7.1 of this manual — trouble shooting for help.

**NOTE:**The inverter can monitor the power grid in real time,The protection can be realized when the power grid is abnormal, so that the inverter is separated



from the power grid.

## 6. Operation interface

### Outlines of this chapter

This section introduces the display, operation, buttons and LED indicator lights of SOFAR 3K~6KTLM-G3 Inverter.

### 6.1. Operation and Display Panel

#### Buttons and Indicator lights



#### Button:

“ ^ ” Short press UP button = go up

“ ^ ” Long press UP button = exit menu or current interface

“ v ” Short press DOWN button = go down

“ v ” Long press DOWN button = enter menu or current interface

#### Indicator Lights:

RUN (Green)

ON: “ Normal ” state

Flash: “ Wait ” or “ Check ” state

FAULT (Red)

ON: “ Fault ” or “ Permanent ” state

## 6.2. Standard Interface

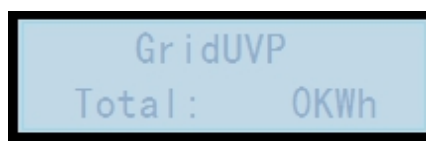
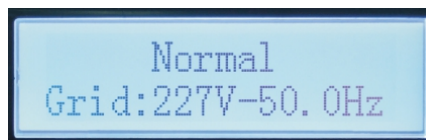
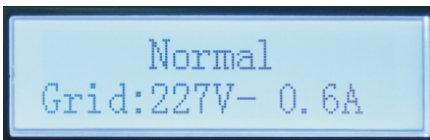
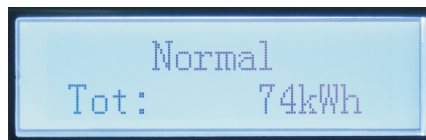
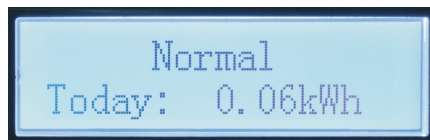
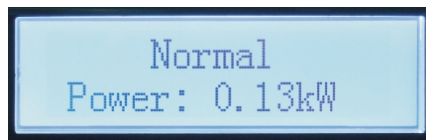

When power-on, LCD interface displays INITIALIZING, refer below picture.



When control board successfully connected with communication board, the LCD display the current state of the inverter, display as shown in the figure below.



• Waiting States, Countdown 10S  
(depends country code, some are 60s)

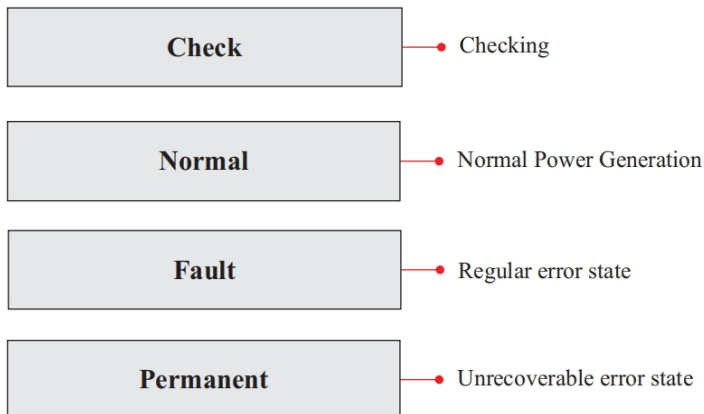

Inverter states includes: wait、check、normal、fault and permanent

**Wait:**Inverter is waiting to Check State at the end of reconnection time. In this state, grid voltage value is between the max and min limits and so on; If not, Inverter will go to Fault State or Permanent State.

**Check:** Inverter is checking isolation resistor, relays, and other safety requirements. It also does self-test to ensure inverter software and hardware are functional. Inverter will go to Fault State or Permanent State if any error or fault occurs.

**Normal:** Inverter enter to Normal State, it is feeding power to the grid; inverter will go to Fault State or Permanent state if any error or fault occurs.

**Fault:**Fault State: Inverter has encountered recoverable error. It should recover if the errors disappear. If Fault State continues; please check the inverter according error code.

**Permanent:**Inverter has encountered unrecoverable error, we need maintainer debug this kind of error according to error code.

When the control board and communication board connection fails, the LCD display interface as shown in the figure below.



## 6.3. Main Interface

Long press the “ √ ” button under standard interface to enter into main interface, including:

Normal	-----Long press the “ √ ”
	<b>1.Enter Setting</b>
	<b>2.Event List</b>
	<b>3.SystemInfo</b>
	<b>4.Display Time</b>
	<b>5.Software Update</b>

(A) “Enter Setting” Interface as below:

1.Enter Setting	-----Long press the “ √ ”	
	<b>1.Set Time</b>	<b>8.Set Input mode</b>
	<b>2.Clear Energy</b>	<b>9.Set Language</b>
	<b>3.Clear Events</b>	<b>10.Set Reflux P</b>
	<b>4.Set SafetyPara</b>	<b>11.EnDRMs</b>
	<b>5.On-Off Control</b>	<b>12.IV Curve Scan</b>
	<b>6.Set Energy</b>	<b>13.Autotest Fast</b>
	<b>7.Set Address</b>	<b>14.Autotest STD</b>

Long press the “ √ ” button to Enter the main interface of "1.Enter Setting" and long press the “ √ ” to enter the setting menu. You can switch up and down to choose what you want by short pressing the “ ^ ” and “ √ ” .

Note1: Some settings need to enter the password (the default password is 0001), when entering the password, short press the “ ^ ” and “ √ ” to change the number, long press the “ √ ” to confirm the current number, and long press the “ √ ” after entering the correct password. If "password error, try again" appears, you will need to re-enter the correct password.

### 1. Set Time

Set the system time for the inverter.

### 2. Clear Energy

Clean the inverter of the total power generation.

### 3. Clear Events

Clean up the historical events recorded in the inverter.

### 4. Set SafetyPara

User can modify the Safety Param of the machine through the usb flash disk, and the user needs to copy the parameter information that needs to be modified into the usb flash disk card in advance.

Note: To enable this feature, please contact the Sofarsolar technical support .

Table 6-1 List of regulated countries

Code	Country	Code	Country
000	000 Germany VDE4105	018	000 EU EN50438
	001 Germany BDEW		001 EU EN50549
	002 Germany VDE0126	019	000 IEC EN61727
001	000 Italia CEI-021 Internal	020	000 Korea
	001 Italia CEI-016 Italia	021	000 Sweden
	002 Italia CEI-021 External	022	000 Europe General
	003 Italia CEI0-21 In Areti	024	000 Cyprus
002	000 Australia	025	000 India
	001 Australia AU-WA	026	000 Philippines
	002 Australia AU-SA	027	000 New Zealand
	003 Australia AU-VIC	028	000 Brazil
	004 Australia AU-QLD		001 Brazil LV
	005 Australia AU-VAR		002 Brazil 230
	006 Australia AUSGRID		003 Brazil 254
007 Australia Horizon	029	000 Slovakia VSD	
003	000 Spain RD1699	029	001 Slovakia SSE
004	000 Turkey		002 Slovakia ZSD
005	000 Denmark	033	000 Ukraine
	001 Denmark TR322	035	000 Mexico LV
006	000 Greece Continent	038	000 Wide-Range-60Hz
	001 Greece island	039	000 Ireland EN50438
007	000 Netherland	040	000 Thailand PEA
008	000 Belgium		001 Thailand MEA
009	000 UK G59/G99	042	000 LV-Range-50Hz
	001 UK G83/G98	044	000 South Africa
010	000 China	046	000 Dubai DEWG
	001 China Taiwan		001 Dubai DEWG MV
011	000 France	107	000 Croatia
	001 France FAR Arrete23	108	000 Lithuania
012	000 Poland		

## 5. On-Off Control

Inverter on-off local control.

## 6. Set Energy

Set the total power generation. You can modify the total power generation through this option.

## 7. Set address

Set the address (when you need to monitor multiple inverters simultaneously), Default 01.

## 8. Set Input mode

SOFAR 3K~6KTLM-G3 has two MPPT channels, which can run independently or in parallel. Users choose the operation mode of MPPT according to the system design. Parallel mode is applicable to the case where two channels are in parallel, independent mode is applicable to the case where two channels of MPPT run independently, and the default mode is independent mode.

## 9. Set Language

Set the inverter display language.

## 10. Set Reflux P

Enable or disable the anti-reflux function of the inverter, and set the reflux power. This function need to be used with external CT, please refer to this manual 4.4.3 CT for details.

## 11. EnDRMs

Enable or disable logical interfaces. Please refer to this manual 4.4.1 Logic interface for details.

## 12. IV Curve Scan

Shadow scanning, when the component is blocked or abnormal, causing multiple power peaks, by enabling this function, the peak point of maximum power can be tracked.

## 13. Autotest Fast

<div style="border: 1px solid black; padding: 5px; display: inline-block;">13.Autotest Fast</div>	OK	Start Autotest	Long press the “ √ ” to start
		Testing 59.S1...	
		↓	Wait
		Test 59.S1 OK!	
		↓	Wait
		Testing 59.S2...	
		↓	Wait
		Test 59.S2 OK!	
		↓	Wait
		Testing 27.S1...	
		↓	Wait
		Test 27.S1 OK!	
		↓	Wait
		Testing 27.S2...	
		↓	Wait
		Test 27.S2 OK!	
		↓	Wait
		Testing 81>S1...	
		↓	Wait
		Test 81>S1 OK!	
		↓	Wait
		Testing 81>S2...	
		↓	Wait
		Test 81>S2 OK!	
		↓	Wait
		Testing 81<S1...	
		↓	Wait
		Test 81<S1 OK!	
	↓	Wait	
	Testing 81<S2...		
	↓	Wait	
	Test 81<S2 OK!		
	↓	Long press the “ √ ”	
	Auto Test OK!		
	↓	Short press the “ √ ”	
	59.S1 threshold 253V 900ms		
	↓	Short press the “ √ ”	
	59.S1: 228V 902ms		
	↓	Short press the “ √ ”	
	59.S2 threshold 264.5V 200ms		

↓	Short press the “v”
59.S2: 229V 204ms	
↓	Short press the “v”
27.S1 threshold 195.5V 1500ms	
↓	Short press the “v”
27.S1: 228V 1508ms	
↓	Short press the “v”
27.S2 threshold 34.5V 200ms	
↓	Short press the “v”
27.S2: 227V 205ms	
↓	Short press the “v”
81>.S1 threshold 50.5Hz 100ms	
↓	Short press the “v”
81>.S1 49.9Hz 103ms	
↓	Short press the “v”
81>.S2 threshold 51.5Hz 100ms	
↓	Short press the “v”
81>.S2 49.9Hz 107ms	
↓	Short press the “v”
81<.S1 threshold 49.5Hz 100ms	
↓	Short press the “v”
81<.S1 50.0Hz 105ms	
↓	Short press the “v”
81<.S2 threshold 47.5Hz 100ms	
↓	Short press the “v”
81<.S2 50.1Hz 107ms	

#### 14. Autotest STD

14.Autotest STD

 Long press the “v”

The test procedure is same as Autotest Fast, but it’s much more time consuming.

#### (B) “Event List” Interface as below:

Event List is used to display the real-time event records, including the total



number of events and each specific ID No. and happening time. User can enter Event List interface through main interface to check details of real-time event records, Event will be listed by the happening time, and recent events will be listed in the front. Please refer to below picture. Long press the “√” enter into main menu interface, and short press the “√” to turn the page in standard interface, then enter into “2.Event List” interface.

2. Event List	
1. Current event	2. History event
Fault information	001 ID04 06150825 ( Display the event sequence number, event ID number, and event occurrence time )

### (C) “SystemInfo” Interface as below

3.SystemInfo	-----Long press the “√”	
	<b>1.Inverter Type</b>	<b>7.Input Mode</b>
	<b>2.Serial Number</b>	<b>8.Remote State</b>
	<b>3.SoftVersion</b>	<b>9.Reflux Power</b>
	<b>4.HardVersion</b>	<b>10.EnDRMs</b>
	<b>5.Country</b>	<b>11.Power Ratio</b>
	<b>6.Modbus Address</b>	

The user enters the main menu by long pressing the“√” button, then long press the“√” button to enter “3. SystemInfo”. Turning the page down can select the system information to view.

### (D) Display Time

Long press the“√” button and short press the button to turn the page in the standard user interface to enter into “4.Display Time”,then long press the “√” button to display the current system time.

### (E) Software Update

User can update software by USB flash drive , Sofarsolar will provide the new update software called firmware for user if it is necessary, The user needs to copy the upgrade file to the USB flash drive.

## 6.4. Update Software online

SOFAR 3K~6KTLM-G3 inverters offer software upgrade via usb flash drive to maximize inverter performance and avoid inverter operation error caused by software bugs.

**Step 1** Insert the usb flash drive into the compute.

**Step 2** SOFAR SOLAR will send the Software code to the user who needs to update. After user receive the file,please decompressing file and cover the original file in usb flash drive.

**Step 3** Insert the usb flash drive into the USB/Wifi interface.

**Step 4**

5.Software Update	Input password	<b>Input 0715</b>
		Start Update
		Updating DSP1
		Updating DSP2
		Updating ARM

**Step 5** If the following errors occur, please upgrade again.If this continues many times, contact technical support for help.

USB Fault	MDSP File Error	SDSP File Error
ARM File Error	Update DSP1 Fail	Update DSP2 Fail
Update ARM Fail		

**Step 6** After the update is completed,turn off the DC breaker, wait for the LCD screen extinguish, then restore the WiFi connection and then turn on the DC breaker and AC breaker again,the inverter will enters the running state. User can check the current software version in SystemInfo>>SoftVersion.

## 7. *Trouble shooting*

### Outlines of this chapter

This topic describes how to perform daily maintenance and troubleshooting to ensure long term proper operation of the inverter.

### 7.1. Trouble shooting

This section contains information and procedures for solving possible problems with the inverter.

- This section help users to identify the inverter fault. Please read the following procedures carefully:
- ✧ Check the warning, fault messages or fault codes shown on the inverter screen, record all the fault information.
- ✧ If there is no fault information shown on the screen, check whether the following requirements are met:
  - Is the inverter mounted in a clean, dry place with good ventilation?
  - Is the DC switch turned ON?
  - Are the cables adequately sized and short enough?
  - Are the input and output connections and wiring in good condition?
  - Are the configuration settings correct for the particular installation?
  - Are the display panel and the communication cables properly connected and undamaged?

Follow the steps below to view recorded problems: Long press the button to enter the main menu from the standard interface. Select “ 2. Event List ” then long press the button to enter event list.

- Earth Fault Alarm  
This inverter complies with IEC 62109-2 clause 13.9 for earth fault alarm monitoring.

If an Earth Fault Alarm occurs, the fault will be displayed on the LCD screen, the red light will be on, and the fault can be found in the history of the fault. For the machine installed with Wi-Fi/GPRS, the alarm information can be seen on the corresponding monitoring website, and can also be received by the APP on the mobile phone.

Table 7-1 Event list

Code	Name	Description	Solution
ID001	GridOVP	The grid voltage is too high	If the alarm occurs occasionally, the possible cause is that the electric grid is abnormal occasionally. Inverter will automatically return to normal operating status when the electric grid's back to normal.
ID002	GridUVP	The grid voltage is too low	
ID003	GridOFP	The grid frequency is too high	
ID004	GridUFP	The grid frequency is too low	If the alarm occurs frequently, check whether the grid voltage/frequency is within the acceptable range. If yes, please check the AC circuit breaker and AC wiring of the inverter. If the grid voltage/frequency is NOT within the acceptable range and AC wiring is correct, but the alarm occurs repeatedly, contact technical support to change the grid over-voltage, under-voltage, over-frequency, under-frequency protection points after obtaining approval from the local electrical grid operator.
ID005	GFCI	Charge Leakage Fault	Internal faults of inverter, switch OFF inverter, wait for 5 minutes, then switch ON inverter. Check whether the problem is solved. If no, please contact technical support.
ID006	OVRT fault	OVRT function is faulty	
ID007	LVRT fault	LVRT function is faulty	
ID008	IslandFault	Island protection error	
ID009	GridOVPIstant1	Transient overvoltage of grid voltage 1	
ID010	GridOVPIstant2	Transient overvoltage of grid voltage 2	
ID011	VGridLineFault	Power grid line voltage error	
ID012	InvOVP	Inverter voltage overvoltage	
ID017	HwADFaultIGrid	Power grid current	

		sampling error	
ID018	HwADFaultDCI	Wrong sampling of dc component of grid current	
ID019	HwADFaultVGri d(DC)	Power grid voltage sampling error (DC)	
ID020	HwADFaultVGri d(AC)	Power grid voltage sampling error (AC)	
ID021	GFCIDeviceFault (DC)	Leakage current sampling error (DC)	
ID022	GFCIDeviceFault (AC)	Leakage current sampling error (AC)	
ID023	HwADFaultDCV	Error in dc component sampling of load voltage	
ID024	HwADFaultIdc	Dc input current sampling error	
ID029	ConsistentFault_ GFCI	Leakage current consistency error	
ID030	ConsistentFault_ Vgrid	Grid voltage consistency error	
ID033	SpiCommFault(D C)	SPI communication error (DC)	
ID034	SpiCommFault(A C)	SPI communication error (AC)	
ID035	SChip_Fault	Chip error (DC)	
ID036	MChip_Fault	Chip error (AC)	
ID037	HwAuxPowerFau lt	Auxiliary power error	
ID041	RelayFail	Relay detection failure	
ID042	IsoFault	Low insulation impedance	Check the insulation resistance between the photovoltaic array and ground (ground), if there is a short circuit, the fault should be repaired in time.
ID043	PEConnectFault	Ground fault	Check ac output PE wire for grounding.
ID044	PvConfigError	Error setting input mode	Check the PV input mode (parallel/independent mode) Settings for the inverter. If not, change the PV input mode.
ID045	CTDisconnect	CT error	Check whether the CT wiring is correct.

ID049	TempFault_Bat	Battery temperature protection	<p>Make sure the inverter is installed where there is no direct sunlight.</p> <p>Please ensure that the inverter is installed in a cool/well ventilated place.</p> <p>Ensure the inverter is installed vertically and the ambient temperature is below the inverter temperature limit.</p>
ID050	TempFault_Heat Sink1	Radiator 1 temperature protection	
ID051	TempFault_Heat Sink2	Radiator 2 temperature protection	
ID052	TempFault_Heat Sin3	Radiator 3 temperature protection	
ID053	TempFault_Heat Sink4	Radiator 4 temperature protection	
ID054	TempFault_Heat Sin5	Radiator 5 temperature protection	
ID055	TempFault_Heat Sin6	Radiator 6 temperature protection	
ID057	TempFault_Env1	Ambient temperature 1 protection	
ID058	TempFault_Env2	Ambient temperature 2 protection	
ID059	TempFault_Inv1	Module 1 temperature protection	
ID060	TempFault_Inv2	Module 2 temperature protection	
ID061	TempFault_Inv3	Module 3 temperature protection	
ID065	VbusRmsUnbalance	Unbalanced bus voltage RMS	
ID066	VbusInstantUnbalance	The transient value of bus voltage is unbalanced	
ID067	BusUVP	Busbar undervoltage during grid-connection	
ID068	BusZVP	Bus voltage low	
ID069	PVOVP	PV over-voltage	<p>Check whether the PV series voltage (Voc) is higher than the maximum input voltage of the inverter. If so, adjust the number of PV modules in series and reduce the PV series voltage to fit the input voltage range of the inverter. After correction, the inverter will automatically return to its normal state.</p>
ID070	BatOVP	Battery over-voltage	<p>Check whether the battery overvoltage setting is inconsistent with the battery</p>

			specification.
ID071	LLCBusOVP	LLC BUS overvoltage protection	Internal faults of inverter, switch OFF inverter, wait for 5 minutes, then switch ON inverter. Check whether the problem is solved. If no, please contact technical support.
ID072	SwBusRmsOVP	Inverter bus voltage RMS software overvoltage	
ID073	SwBusInstantOVP	Inverter bus voltage instantaneous value software overvoltage	
ID081	SwBatOCP	Battery overcurrent software protection	
ID082	DciOCP	Dci overcurrent protection	
ID083	SwOCPInstant	Output instantaneous current protection	
ID084	SwBuckBoostOCP	BuckBoost software flow	
ID085	SwAcRmsOCP	Output effective value current protection	
ID086	SwPvOCPInstant	PV overcurrent software protection	
ID087	IpvUnbalance	PV flows in uneven parallel	
ID088	IacUnbalance	Unbalanced output current	
ID097	HwLLCBusOVP	LLC bus hardware overvoltage	
ID098	HwBusOVP	Inverter bus hardware overvoltage	
ID099	HwBuckBoostOCP	BuckBoost hardware overflows	
ID100	HwBatOCP	Battery hardware overflows	
ID102	HwPVOC	PV hardware overflows	
ID103	HwACOCP	Ac output hardware overflows	
ID110	Overload1	Overload protection 1	Please check whether the inverter is operating under overload.
ID111	Overload2	Overload protection 2	
ID112	Overload3	Overload protection 3	
ID113	OverTempDerating	Internal temperature is too high.	Make sure the inverter is installed where there is no direct sunlight. Please ensure that the inverter is installed in a cool/well ventilated

			place. Ensure the inverter is installed vertically and the ambient temperature is below the inverter temperature limit.
ID114	FreqDerating	AC frequency is too high	Please make sure the grid frequency and voltage is within the acceptable range.
ID115	FreqLoading	AC frequency is too low	
ID116	VoltDerating	AC voltage is too high	
ID117	VoltLoading	AC voltage is too low	
ID124	BatLowVoltageAlarm	Battery low voltage protection	Please check whether the battery voltage of the inverter is too low.
ID125	BatLowVoltageShut	Battery low voltage shutdown	
ID129	unrecoverHwAcOCP	Output hardware overcurrent permanent failure	Internal faults of inverter, switch OFF inverter, wait for 5 minutes, then switch ON inverter. Check whether the problem is solved. If no, please contact technical support.
ID130	unrecoverBusOVP	Permanent Bus overvoltage failure	
ID131	unrecoverHwBusOVP	Permanent Bus hardware overvoltage failure	
ID132	unrecoverIpvUnbalance	PV uneven flow permanent failure	
ID133	unrecoverEPSBatOCP	Permanent battery overcurrent failure in EPS mode	
ID134	unrecoverAcOCPInstant	Output transient overcurrent permanent failure	
ID135	unrecoverIacUnbalance	Permanent failure of unbalanced output current	
ID137	unrecoverPvConfigError	Input mode setting error permanent failure	
ID138	unrecoverPVOCPInstant	Input overcurrent permanent fault	
ID139	unrecoverHwPVOCP	Input hardware overcurrent permanent failure	
ID140	unrecoverRelayF	Permanent relay failure	Internal faults of inverter, switch OFF inverter, wait for 5 minutes, then switch ON inverter. Check whether the problem is solved.



	ail		If no, please contact technical support.
ID141	unrecoverVbusUnbalance	Bus voltage unbalanced permanent failure	
ID145	USBFault	USB fault	Check the USB port of the inverter
ID146	WifiFault	Wifi fault	Check the Wifi port of the inverter
ID147	BluetoothFault	Bluetooth fault	Check the bluetooth connection of the inverter
ID148	RTCFault	RTC clock failure	Internal faults of inverter, switch OFF inverter, wait for 5 minutes, then switch ON inverter. Check whether the problem is solved. If no, please contact technical support.
ID149	CommEEPROM Fault	Communication board EEPROM error	
ID150	FlashFault	Communication board FLASH error	
ID153	SciCommLose(DC)	SCI communication error (DC)	
ID154	SciCommLose(AC)	SCI communication error (AC)	
ID155	SciCommLose(Fuse)	SCI communication error (Fuse)	
ID156	SoftVerError	Inconsistent software versions	Contact for technical support and software upgrades.
ID157	BMSCommunicationFault	Communication failure of lithium battery	Make sure your battery is compatible with the inverter. CAN communication is recommended. Check the communication line or port of the battery and inverter for faults.
ID161	ForceShutdown	Force shutdown	The inverter is performed a forced shutdown
ID162	RemoteShutdown	Remote shutdown	The inverter is performed a remote shutdown.
ID163	Drms0Shutdown	Drms0 shutdown	The inverter is performed with a Drms0 shutdown.
ID165	RemoteDerating	Remote derating	The inverter is performed for remote load reduction.
ID166	LogicInterfaceDerating	Logic interface derating	The inverter is loaded by the execution logic interface.
ID167	AlarmAntiRefluxing	Anti reflux derating	The inverter is implemented to prevent countercurrent load drop.
ID169	FanFault1	Fan 1 fault	Please check whether the fan 1 of inverter is running normally.
ID170	FanFault2	Fan 2 fault	Please check whether the fan 2 of inverter is running normally.
ID171	FanFault3	Fan 3 fault	Please check whether the fan 3 of

			inverter is running normally.
ID172	FanFault4	Fan 4 fault	Please check whether the fan 4 of inverter is running normally.
ID173	FanFault5	Fan 5 fault	Please check whether the fan 5 of inverter is running normally.
ID174	FanFault6	Fan 6 fault	Please check whether the fan 6 of inverter is running normally.
ID177	BMS OVP	BMS over-voltage alarm	Internal failure of lithium battery, close inverter and lithium battery, and wait 5 minutes to open inverter and lithium battery. Check that the problem is resolved. If not, please contact technical support.
ID178	BMS UVP	BMS under-voltage alarm	
ID179	BMS OTP	BMS high temperature warning	
ID180	BMS UTP	BMS low temperature alarm	
ID181	BMS OCP	Warning of overload in charge and discharge of BMS	
ID182	BMS Short	BMS short circuit alarm	

## 7.2. Maintenance

Inverters generally do not need any daily or routine maintenance. Heat sink should not be blocked by dust, dirt or any other items. Before the cleaning, make sure that the DC SWITCH is turned OFF and the circuit breaker between inverter and electrical grid is turned OFF. Wait at least for 5 minutes before the Cleaning.

### ❖ Inverter cleaning

Please clean the inverter with an air blower, a dry & soft cloth or a soft bristle brush. Do NOT clean the inverter with water, corrosive chemicals, detergent, etc.

### ❖ Heat sink cleaning

For the long-term proper operation of inverters, ensure there is enough space around the heat sink for ventilation, check the heat sink for blockage (dust, snow, etc.) and clean them if they exist. Please clean the heat sink with an air blower, a dry & soft cloth or a soft bristle brush. Do NOT clean the heat sink with water, corrosive chemicals, detergent, etc.

## 8. Technical data

### Outlines of this chapter

This topic lists the technical specifications for all SOFAR 3K~6KTLM-G3 inverters.

### 8.1. Input parameters (DC)

Technical Data	SOFAR 3KTLM- G3	SOFAR 3.6KTL M-G3	SOFAR 4KTLM- G3	SOFAR 4.6KTL M-G3	SOFAR 5KTLM- G3	SOFAR 5KTLM- G3-A	SOFAR 6KTLM- G3
Recommended Max.PV input power	4500W <sub>p</sub>	5400W <sub>p</sub>	6000W <sub>p</sub>	7000W <sub>p</sub>	7500W <sub>p</sub>	7500W <sub>p</sub>	9000W <sub>p</sub>
MAX. DC power for single MPPT	3500W	3500W	3500W	3500W	3750W	3750W	4500W
Number of MPP trackers	2						
Number of DC input	1 for each MPPT						
Max. input voltage	600V						
Start-up voltage	90V						
Rated input voltage	380V						
MPPT operating voltage range	80V~550V						
Full power MPPT voltage range	200V~ 500V	200V~ 500V	200V~ 500V	200V~ 500V	210V~ 500V	210V~ 500V	260V~ 500V
Max. Input MPPT current	15A/15A						
Max. Input short circuit current per MPPT	22.5A/22.5A						

## 8.2. Output parameters (AC)

Technical Data	SOFAR 3KTLM-G3	SOFAR 3.6KTL M-G3	SOFAR 4KTLM-G3	SOFAR 4.6KTL M-G3	SOFAR 5KTLM-G3	SOFAR 5KTLM-G3-A	SOFAR 6KTLM-G3
Rated power	3000W	3680W	4000W	4600W	5000W	5000W	6000W
Max.AC power	3300VA	3680VA	4400VA	4600VA	5500VA	5000VA	6000VA
Nominal output current	13.6A	16A	18.2A	21A	22.7A	21.7A	27.3A
Max.output current	15A	16A	20A	23A	25A	21.7A	29A
Nominal grid voltage	L/N/PE,220Vac 230Vac 240Vac						
Grid voltage range	180-276Vac( According to local grid standard )						
Nominal grid frequency	50Hz/60Hz						
Grid frequency range	45~55Hz/54~66Hz( According to local grid standard )						
Active power adjustable range	0~100%						
THDi	<3%						
Power factor	1 default( +/-0.8 adjustable)						
Power limit export	Zero export or adjustable power limit export						
Current (inrush)	23.9A /20ms						
Maximum output fault current	200a.c.A , 1 μ s						
Maximum output overcurrent protection	27.3a.c.A						
backfeed current	0A						

## 8.3. Efficiency, Protection and Communication

Technical Data	SOFAR 3KTLM-G3	SOFAR 3.6KTL M-G3	SOFAR 4KTLM-G3	SOFAR 4.6KTL M-G3	SOFAR 5KTLM-G3	SOFAR 5KTLM-G3-A	SOFAR 6KTLM-G3
Max. efficiency	98.2%	98.2%	98.2%	98.4%	98.4%	98.4%	98.4%
Euro efficiency	97.3%	97.3%	97.3%	97.5%	97.5%	97.5%	97.5%
MPPT efficiency	>99.9%						
Self-consumption at night	<1W						
DC reverse polarity protection	Yes						
DC switch	Optional						
AFCI protection	Optional						
Protective class/overvoltage category	I /III						
Safety protection	Anti islanding,RCMU,Ground fault monitoring						
SPD	MOV:Type III standard						
Power management unit	According to certification and request						
Communication	RS485/USB/Bluetooth, Optional:WiFi/GPRS						
Operation data storage	25 years						

## 8.4. General Date

Technical Data	SOFAR 3KTLM-G3	SOFAR 3.6KTL M-G3	SOFAR 4KTLM-G3	SOFAR 4.6KTL M-G3	SOFAR 5KTLM-G3	SOFAR 5KTLM-G3-A	SOFAR 6KTLM-G3
Topology	non-isolated						
Ambient temperature range	-30~+60℃						
Degree of protection	IP65						
Allowable relative humidity range	0~100%						
Noise	<25dB						
Cooling	Natural						
Max.operating altitude	4000m						
Outline Dimension	349*344*164mm						
Weight	9.2kg			10kg			
Display	LCD&Bluetooth+APP						
Warranty	5 years/7 years/10 years						
Over voltage category	DC side: overvoltage II AC side: overvoltage III						
EMC	EN 61000-6-2, EN 61000-6-3, EN 61000-3-2, EN 61000-3-3, EN 61000-3-11, EN 61000-3-12						
Safety standards	IEC 62109-1/2, IEC 62116, IEC 61727, IEC 61683, IEC 60068(1,2,14,30)						
Grid standards	VDE-AR-N 4105, VDE V 0126-1-1, V 0124-100, AS/NZS 4777, CEI 0-21, G98/G99, C10/11, EN 50549, RD 1699						

## 9. *Quality Assurance*

### **Standard warranty period**

The standard warranty period of inverter is 60 months (5 years). There are two calculation methods for the warranty period:

1. Purchase invoice provided by the customer: the first flight provides a standard warranty period of 60 months (5 years) from the invoice date;
2. The customer fails to provide the invoice: from the production date (according to the SN number of the machine), Our company provides a warranty period of 63 months (5.25 years).
3. In case of any special warranty agreement, the purchase agreement shall prevail.

### **Extended warranty period**

Within 12 months of the purchase of the inverter (based on the purchase invoice) or within 24 months of the production of the inverter (SN number of machine, based on the first date of arrival), Customers can apply to buy extended warranty products from the company's sales team by providing the product serial number, Our company may refuse to do not conform to the time limit extended warranty purchase application. Customers can buy an extended warranty of 5, 10, 15 years.

If the customer wants to apply for the extended warranty service, please contact the sales team of our company. to purchase the products that are beyond the purchase period of extended warranty but have not yet passed the standard quality warranty period. Customers shall bear different extended premium.

During the extended warranty period, pv components GPRS, WIFI and lightning protection devices are not included in the extended warranty period. If they fail during the extended warranty period, customers need to purchase and replace them from the our company.

Once the extended warranty service is purchased, our company will issue the extended warranty card to the customer to confirm the extended warranty period.

## Invalid warranty clause

Equipment failure caused by the following reasons is not covered by the warranty:

- 1) The "warranty card" has not been sent to the distributor or our company;
- 2) Without the consent of our company to change equipment or replace parts;
- 3) Use unqualified materials to support our company 's products, resulting in product failure;
- 4) Technicians of non-company modify or attempt to repair and erase the product serial number or silk screen;
- 5) Incorrect installation, debugging and use methods;
- 6) Failure to comply with safety regulations (certification standards, etc.);
- 7) Damage caused by improper storage by dealers or end users;
- 8) Transportation damage (including scratches caused by internal packaging during transportation).Please claim directly from the transportation company or insurance company as soon as possible and obtain damage identification such as container/package unloading;
- 9) Failure to follow the product user manual, installation manual and maintenance guidelines;
- 10) Improper use or misuse of the device;
- 11) Poor ventilation of the device;
- 12) The product maintenance process does not follow relevant standards;
- 13) Failure or damage caused by natural disasters or other force majeure (such as earthquake, lightning strike, fire, etc.)



## Statement

If you have purchased this product in Australia, you should be aware that this warranty is provided in addition to other rights and remedies held by a consumer at law.

Our goods come with guarantees that cannot be excluded under the Australian Consumer Law. You are entitled to a replacement or refund for a major failure and compensation for any other reasonably foreseeable loss or damage. You are also entitled to have the goods repaired or replaced if the goods fail to be of acceptable quality and the failure does not amount to a major failure.



Product Name: Solar Grid-tied Inverter

Company Name: Shenzhen SOFARSOLAR Co., Ltd.

ADD: 401, Building 4, AnTongDa Industrial Park, District 68, XingDong Community,  
XinAn Street, BaoAn District, Shenzhen, Guangdong.P.R. China

Email: [service@sofarsolar.com](mailto:service@sofarsolar.com)

Tel: 0510-6690 2300

Web: [www.sofarsolar.com](http://www.sofarsolar.com)