

User manual

Solar Grid-tied Inverter

Product Model: SOFAR 3.3~12KTLX-G3



Content

Preface.....	II
1. Basic Safety Information.....	- 1 -
1.1. Requirement for Installation and Maintenance.....	- 1 -
1.2. Symbols and signs.....	- 4 -
2. Product Characteristics.....	- 7 -
2.1. Intended Use.....	- 7 -
2.2. Function Description.....	- 11 -
2.3. Electrical block diagram.....	- 12 -
2.4. Efficiency and derating curve.....	- 12 -
3. Installation.....	- 13 -
3.1. Installation Process.....	- 13 -
3.2. Checking Before Installation.....	- 13 -
3.3. Tools.....	- 16 -
3.4. Determining the Installation Position.....	- 18 -
3.5. Moving of inverter.....	- 19 -
3.6. Installation.....	- 20 -
4. Electrical Connection.....	- 22 -
4.1. Electrical Connection.....	- 23 -
4.2. Grounding Connection (PE).....	- 23 -
4.3. Connect grid side of inverter (AC-Output).....	- 25 -
4.4. Connect PV side of inverter (DC-Input).....	- 28 -
4.5. Communication Connection.....	- 30 -
5. Commissioning of inverter.....	- 36 -
5.1. Cable Connection Inspection.....	- 36 -
5.2. Start Inverter.....	- 36 -
6. Operation interface.....	- 38 -
6.1. Operation and Display Panel.....	- 38 -
6.2. Standard Interface.....	- 39 -
6.3. Main Interface.....	- 41 -
6.4. Updating Inverter Software.....	- 47 -
6.5. Smart meter instruction.....	- 48 -
7. Trouble shooting and maintenance.....	- 50 -
7.1. Troubleshooting.....	- 50 -
7.2. Maintenance.....	- 58 -
8. Technical Data.....	- 59 -
9. Quality Assurance.....	- 65 -

Preface

Notice

The products, services or features you purchased shall be subject to the company's commercial contracts and terms. All or part of the products and services described in this document may not within the scope of your purchase. Unless additional terms and conditions in your contract, the company does not make any statement or guarantee on the contents of this document.

Save this Instruction

This manual must be considered as an integral part of the equipment. Customer can print the electronic version to hard copy and keeping properly for future reference. Anyone who operates the device at any time must operate in accordance with the requirements of this manual.

Copyright Declaration

The copyright of this manual belongs to Shenzhen SOFARSOLAR Co., Ltd. Any corporation or individual should not plagiarize, partially cope or fully copy (including software, etc.), not allow to duplication and publishment in any form and any way. All rights reserved, SOFARSOLAR reserves the right of final interpretation. This manual subject to modify according to user's or customer's feedback. Please check our website at <http://www.sofarsolar.com> for lasted version. The current Version updated at 20220317.

Shenzhen SOFARSOLAR Co., Ltd

Location:11/F., Gaoxinqi Technology Building, No.67 Area,Xingdong Community, Xin'an Sub-district, Bao'an District, Shenzhen City,China.

Postcode: 518000

Company Website: www.sofarsolar.com

Email: service@sofarsolar.com

● **Outline**

This manual is an integral part of SOFAR 3.3~12KTLX-G3. It describes the assembly, installation, commissioning, maintenance and failure of the product. Please read it carefully before operating.

● **Scope of Validity**

This manual contains important instructions for:





SOFAR 3.3KTLX-G3 SOFAR 4.4KTLX-G3 SOFAR 5KTLX-G3-A SOFAR 5.5KTLX-G3
 SOFAR 6.6KTLX-G3 SOFAR 8.8KTLX-G3 SOFAR 11KTLX-G3
 SOFAR 8.8KTLX-G3-A SOFAR10KTLX-G3-A SOFAR 11KTLX-G3-A SOFAR 12KTLX-G3

● **Target Group**

This manual is for qualified electricians. The tasks described in this manual only can be performed by qualified electricians.

● **Symbols Used**

The following types of safety instruction and general information appear in this document as described below:

 Danger	<p>“ Danger ” indicates a hazardous situation which, if not avoided, will result in death or serious injury.</p>
 Warning	<p>“ Warning ” indicates a hazardous situation which, if not avoided, could result in death or serious injury</p>
 Caution	<p>“ Caution ” indicates a hazardous situation which, if not avoided, could result in minor or moderate injury</p>
 Attention	<p>“ Attention ” indicates there are potential risks, if fail to prevent, may lead to equipment cannot normally or property damage.</p>
 Note	<p>“ Note ” provides additional information and tips that are valuable for the optimal operation of the product.</p>

1. Basic Safety Information

Outlines of this Chapter

Please read the instruction carefully. Faulty operation may cause serious injury or death.

	If you have any question or problem when you read the following information, please contact Shenzhen SOFARSOLAR CO., Ltd.
Note	

Safety Instruction

Introduce the safety instruction during installation and operation of SOFAR 3.3~12KTLX-G3.

Symbols Instruction

This section gives an explanation of all the symbols shown on the inverter and on the type label.

1.1. Requirement for Installation and

Maintenance

Installation of SOFAR 3.3~12KTLX-G3 on-grid inverter must conform with laws, regulations, codes and standards applicable in the jurisdiction.

Before installing and adjusting the produce, please read all of instructions, cautions and warnings in this manual

Before connecting the product to the electrical utility grid, contact the local utility company for allowance. Also, this connection must be made only by qualified electrician.

If the failure persists, please contact the nearest authorized maintenance center. If you don't know which service center is closest to you, please contact your local distributor. Don't repair the product by yourself, which may lead serious injury or damage.

Qualified Person

When inverter is working, it contains lethal voltages and went hot in some area. Improper installation or maloperation could cause serial damage and injury. To reduce the risk of personal injury and to ensure the safe installation and operation of the product, only a qualified electrician is allowed to execute transportation, installation, commissioning and maintenance. Shenzhen SOFARSOLAR Co, Ltd does not take any responsibility for the property destruction and personal injury because of any incorrect use.

Label and Symbols

SOFAR 3.3~12KTLX-G3 has type label attach the side of product which contact important information and technical data, the type label must permanent attached to the product.

SOFAR 3.3~12KTLX-G3 has warning symbol attached the product which contact information of safety operation. The warning symbol must permanent attached to the product.

Installation location requirement

Please install the inverter according to the following section. Place inverter in an appropriate bearing capacity objects (such as solid brick wall, or strength equivalent mounting surface, etc.) and make sure inverter vertical placed. A proper installation location must have enough space for fire engine access in order for maintenance if faulty occur. Ensure the inverter is installed in a wall ventilated environment and have enough air-cooling cycle. Air humidity should less than 90%.

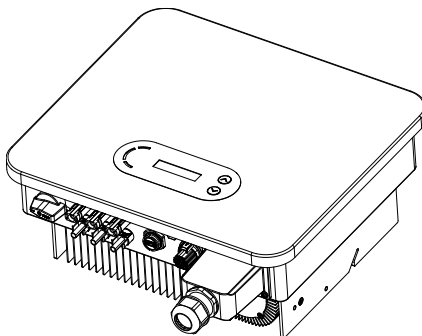



Transportation Requirement

Inverter is in the good electrical and physical condition when it ship out from factory. During transport, inverter must be placed in its original package or other proper package. Transportation company should responsible for any damage during transport period.



If you find any packing problems that may cause the damage of inverter or any visible damage, please notice the responsible transportation company immediately. You can ask your installer or SOFARSOLAR for help is necessary.

Electrical Connection



Please comply with all the current electrical regulations about accident prevention in dealing with the current inverter.

 Danger	Before the electrical connection, use opaque material to cover the PV modules or disconnect PV string DC switch. PV arrays will produce dangerous voltage if it is exposure under sun
 Warning	All operation must accomplish by certified electrical engineer <ul style="list-style-type: none"> ● Must be trained; ● Completely read the manual operation and understand all information
 Attention	Must get permission by local utility company before connecting to grid and the connection must be done by certified electrical engineers

Operation

 Danger	Touching the utility grid or the terminal conductors can lead to lethal electric shock or fire! Do not touch non-insulated cable ends, DC conductors and any live components of the inverter. Attention to any electrical relevant instruction and document.
 Attention	Enclosure or internal components may get hot during operation. Do not touch hot surface or wear insulated gloves. Keep it away from kids!

Maintenance and repair

 Danger	<p>Before any repair work, turn OFF the AC circuit breaker between the inverter and electrical grid first, then turn OFF the DC switch. After turning OFF the AC circuit breaker and DC switch wait for at least 5 minutes before carry any maintenance or repair work.</p>
 Attention	<p>Inverter should not work again until removing all faults. If any repair work is required, please contact local authorized service center. Should not open the inverter cover without authorized permit, SOFARSOLAR does not take any responsibility for that.</p>



EMC/Noise Level



Electromagnetic compatibility (EMC) refers to that on electrical equipment functions in a given electromagnetic environment without any trouble or error, and impose no unacceptable effect upon the environment. Therefore, EMC represents the quality characters of an electrical equipment.

- The inherent noise-immune character: immunity to internal electrical noise
- External noise immunity: immunity to electromagnetic noise of external system
- Noise emission level: influence of electromagnetic emission upon environment

 Danger	<p>Electromagnetic radiation from inverter may be harmful to health! Please do not continue to stay away from the inverter in less than 20cm when inverter is working</p>
--	---





1.2. Symbols and signs





 Danger	<p>High voltage of inverter may be harmful to health! Only certified engineer can operate the product; Juveniles, Disable, should not use this product; Keep this product out of the reach of children;</p>
 Caution	<p>Caution of burn injuries due to hot enclosure! Only touch the screen and pressing key of the inverter while it is working.</p>

	PV array should be grounded in accordance to the requirements of the local electrical grid company.
Attention	
	Ensure the maximum DC voltage input is less than the maximum inverter DC voltage (including in low temperature condition). Any damage cause by overvoltage, SOFARSOLAR will not take the responsibility including warranty.
Warning	

Signs on the Product and on the Type Label

SOFAR 3.3~12KTLX-G3 has some safety symbols on the inverter. Please read and fully understand the content of the symbols before installation.

Symbols	Name	Explanation
	This is a residual voltage in the inverter!	After disconnect with the DC side, there is a residual voltage in the inverter, operator should wait for 5 minutes to ensure the capacitor is completely discharged.
	Caution of high voltage and electric shock	The products operates at high voltages. Prior to performing any work on the product, disconnect the product from voltage sources. All work on the product must be carried out by qualified persons only.
	Caution of hot surface	The product can get hot during operation. Avoid contact during operation. Prior to performing any work on the product, allow the product to cool down sufficiently.
	Comply with the Conformite Euroeenne (CE) Certification	The product complies with the CE Certification.
	Grounding Terminal	This symbol indicates the position for the connections of an additional equipment grounding conductor.

	<p>Observe the documentation</p>	<p>Read all documentation supplied with the product before install.</p>
	<p>Positive pole and negative pole</p>	<p>Positive pole and negative pole of the input voltage (DC).</p>
	<p>Temperature</p>	<p>Indicated the temperature allowance range.</p>
	<p>RCM logo</p>	<p>RCM (Regulatory Compliance Mark) The product complies with the requirements of the applicable Australian standards.</p>

2. Product Characteristics

Outlines of this Chapter

Product Dimensions

Introduce the field of use and the dimensions of the product

Function Description

Introduce working principle and internal components of the product

Efficiency Curves

Introduce the efficiency curves of the product

2.1. Intended Use

Field of use

SOFAR 3.3~12KTLX-G3 is a transformer-less on grid PV inverter, that converts the direct current of the PV panels to the grid-compliant, three-phase current and feeds into the utility grid.

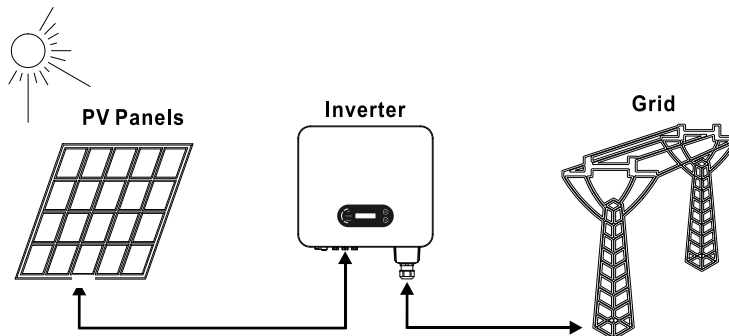

Figure 2-1 PV Grid-Tied System

SOFAR 3.3~12KTLX-G3 may only be operated with PV arrays (photovoltaic module and cabling) for on grid condition. Do not use this product for any other or additional purposes. Any damage or property loss due to any use of the product other than described in this section, SOFARSOLAR will not take the responsibility. DC input of the product must be PV module, other source such

like DC sources, batteries will against the warranty condition and SOFARSOLAR will not take the responsibility.

Intended grid types

SOFAR 3.3~12KTLX-G3 configurations. For the TT type of electricity grid, the voltage between neutral and earth should be less than 30V. inverters are compatible with TN-S, TN-C, TN-C-S, TT, IT grid.

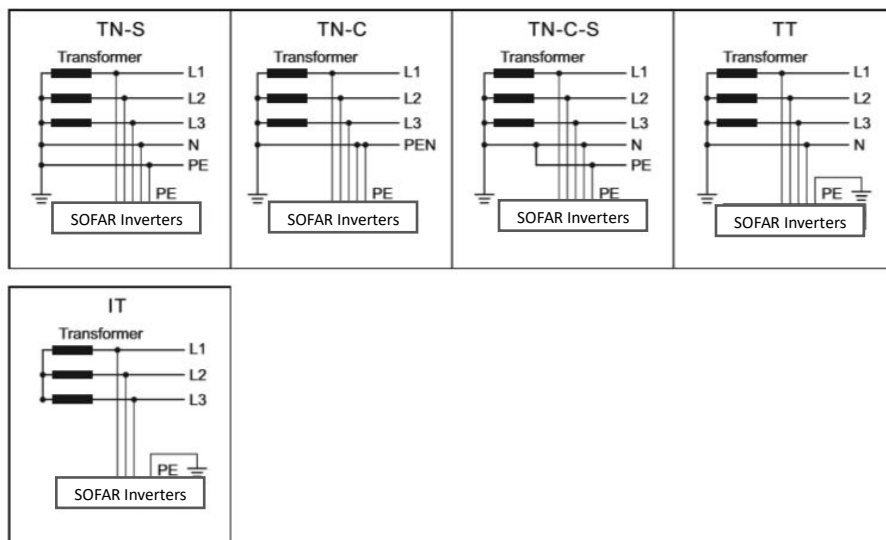

Figure2-2 Overview of the grid configurations

Product Dimensions

The choice of optional parts of inverter should be made by a qualified technician who knows the installation conditions clearly.

Dimensions Description

SOFAR 3.3KTLX-G3

SOFAR 4.4KTLX-G3

SOFAR 5KTLX-G3-A

SOFAR 5.5KTLX-G3

SOFAR 6.6KTLX-G3

SOFAR 8.8KTLX-G3-A

SOFAR 8.8KTLX-G3

SOFAR 10KTLX-G3-A

SOFAR 11KTLX-G3-A

SOFAR 11KTLX-G3

SOFAR 12KTLX-G3

L×W×H=430*385*182mm

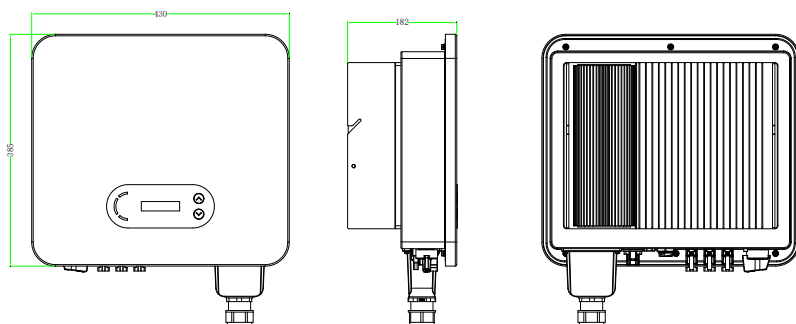

Figure 2-3 Front, side and back of the machine (3.3~12K)

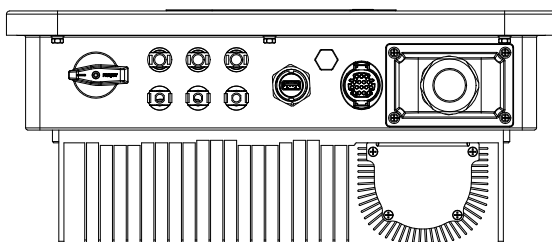

Figure 2-4 Bottom view

Note: 3.3KTLX-G3, 4.4KTLX-G3, 5KTLX-G3-A, 5.5KTLX-G3, 6.6KTLX-G3, 8.8KTLX-G3, 11KTLX-G3 supports 2-channel PV string input;

8.8KTLX-G3-A, 10KTLX-G3-A, 11KTLX-G3-A, 12KTLX-G3 supports 3-channel PV string input.

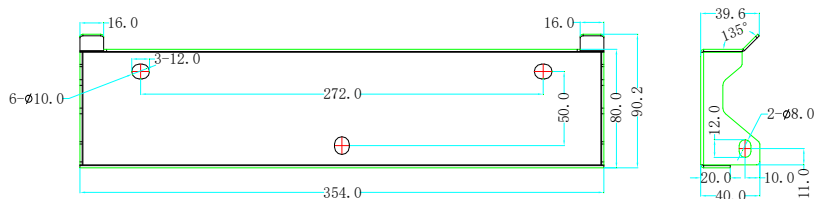

Figure 2-5 bracket dimensions

Function description of inverter box bottom

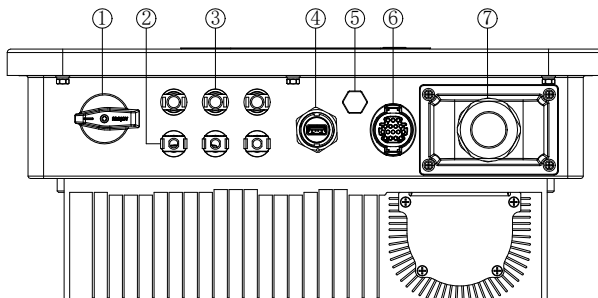

Figure 2-6 Bottom view of the SOFAR 3.3~12KTLX-G3

1. DC Switch
2. DC negative poles connectors
3. DC positive poles connectors
4. USB Port (for WIFI or Ethernet communication)
5. Breather valve
6. COM Port (for RS485 communication)
7. AC output

Labels on the equipment

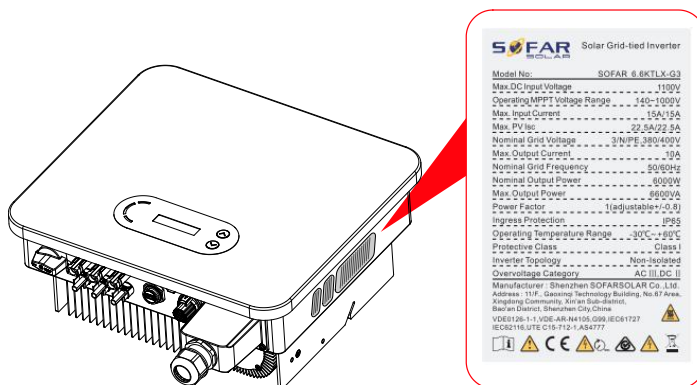

Figure 2-7 Product label

Note: label must NOT be hidden with objects and extraneous parts (rags, boxes, equipment, etc.); they must be cleaned regularly and kept visible at all times.

2.2. Function Description

DC power generated by PV arrays is filtered through Input Board then enter Power Board. Input Board also offer functions such as insulation impedance detection and input DC voltage/ current detection. DC power is converted to AC power by Power Board. AC power is filtered through Output Board then AC power is fed into the grid. Output Board also offer functions such as grid voltage/ output current detection, GFCI and output isolation relay. Control Board provides the auxiliary power, controls the operation state of inverter and shows the operation status by Display Board. Display Board displays fault code when inverter is abnormal operation conditions. At the same time, Control Board can trigger the replay to protect the internal components.

Function Module

A. Energy management unit

Remote control to start/ shut down inverter through an external control

B. Feeding reactive power into the grid

The inverter is able to produce reactive power thus to feed it into the grid through the setting of the phase shift factor. Feed-in management can be controlled directly by APP or through a RS485 interface.

C. Limited the active power fed into grid

If enable the limited of active power function, inverter can limit the amount of active power fed into the grid to the desired value (expressed as percentage)

D. Self-power reduction when grid is over frequency

If grid frequency is higher than the limited value, inverter will reduce the output power to ensure the grid stability

E. Data transmission

Inverter or a group of inverters can be monitored remotely through an advanced communication system based on RS485 interface or via USB port.

F. Software update

USB interface for uploading the firmware, remotely uploading by using USB acquisition stick (WIFI or Ethernet) is also available.

2.3. Electrical block diagram

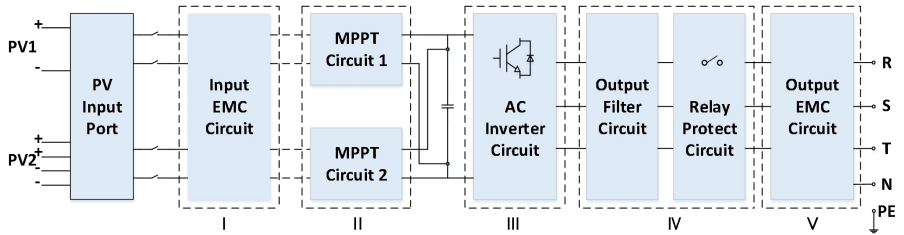

Figure 2-8 Schematic diagram

2.4. Efficiency and derating curve

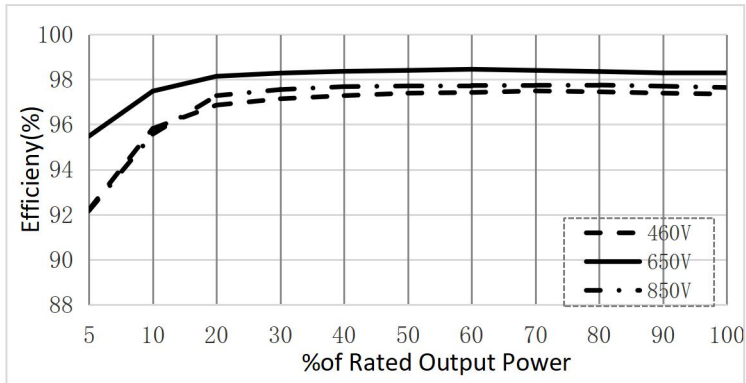

Figure 2-9 Power efficiency curve (take 12KW for example)

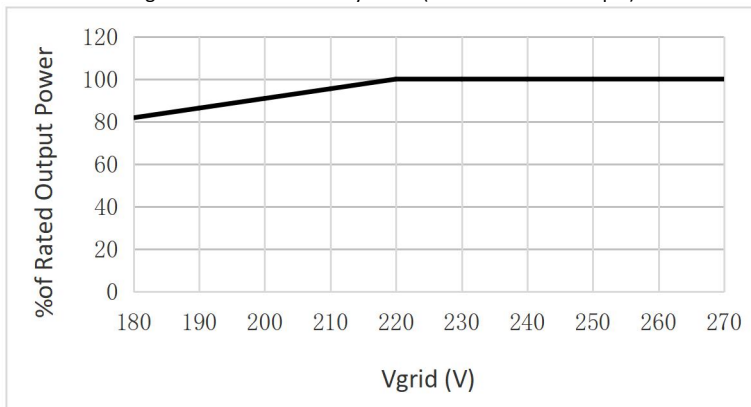





Figure 2-10 Rated Power ratio vs Grid Voltage

3. Installation

Outlines of this Chapter

This topic describes how to install this product, please read carefully before install.

 Dangers	<p>Do NOT install the product on flammable material Do NOT store this product in potentially explosive atmospheres</p>
 Caution	<p>The enclosure and heat sink will get hot during operation, please do not mount the product at a easy to reach location</p>
 Attention	<p>Consider the weight of this product when doing transport and moving Choose an appropriate mounting position and surface At least two persons for installation</p>

3.1. Installation Process

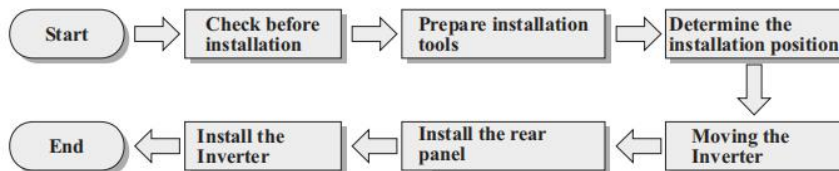

3.2. Checking Before Installation





Checking Outer Packing Materials



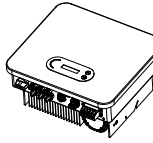
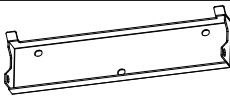

Before unpacking, please check the condition of the outer package materials if any damaged found, such as holes, cracks, please not unpack the product, contact your distributor immediately. Recommend installing the product within 24 hours after unpacking the package.

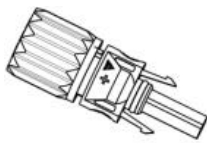

Checking Deliverable

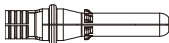
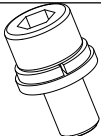
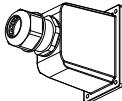
After unpacking, please check according to following table, to see whether all the parts were included in the packing, please contact your distributor immediately if anything missing or damage.

Figure 3-1 Components and mechanical parts that inside the package

No	Pictures	Description	Quantity
1		SOFAR 3.3~12KTLX-G3	1 PCS
2		Rear Panel	1 PCS
3		M6*80 Hexagon screws	3 PCS
4		PV+ input connector	8.8KTLX-G3-A 3 PCS 10KTLX-G3-A 3 PCS 11KTLX-G3-A 3 PCS 12KTLX-G3 3 PCS 3.3KTLX-G3 2 PCS 4.4KTLX-G3 2 PCS 5KTLX-G3-A 2 PCS 5.5KTLX-G3 2 PCS 6.6KTLX-G3 2 PCS 8.8KTLX-G3 2 PCS 11KTLX-G3 2 PCS
5		PV- input connector	8.8KTLX-G3-A 3 PCS 10KTLX-G3-A 3 PCS 11KTLX-G3-A 3 PCS 12KTLX-G3 3 PCS 3.3KTLX-G3 2 PCS 4.4KTLX-G3 2 PCS 5KTLX-G3-A 2 PCS 5.5KTLX-G3 2 PCS 6.6KTLX-G3 2 PCS 8.8KTLX-G3 2 PCS 11KTLX-G3 2 PCS
6		PV+ metal pin	8.8KTLX-G3-A 3 PCS 10KTLX-G3-A 3 PCS

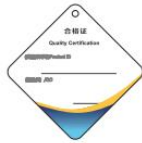
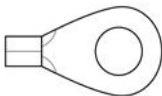

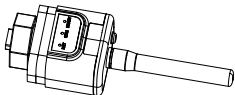
			11KTLX-G3-A 3 PCS 12KTLX-G3 3 PCS 3.3KTLX-G3 2 PCS 4.4KTLX-G3 2 PCS 5KTLX-G3-A 2 PCS 5.5KTLX-G3 2 PCS 6.6KTLX-G3 2 PCS 8.8KTLX-G3 2 PCS 11KTLX-G3 2 PCS
7		PV- metal pin	8.8KTLX-G3-A 3 PCS 10KTLX-G3-A 3 PCS 11KTLX-G3-A 3 PCS 12KTLX-G3 3 PCS 3.3KTLX-G3 2 PCS 4.4KTLX-G3 2 PCS 5KTLX-G3-A 2 PCS 5.5KTLX-G3 2 PCS 6.6KTLX-G3 2 PCS 8.8KTLX-G3 2 PCS 11KTLX-G3 2 PCS
8		M6*12 Hexagon screws	3 PCS
9		AC waterproof cover	1 PCS
10		M4*12 cross screw (For locking the waterproof cover)	4 PCS
11		Manual	1PCS
12		Warranty Card	1PCS







13		Quality Certificate	1PCS
14		R-type terminal	5PCS
15	 Or 	Communication Terminal	1PCS
16		USB acquisition stick (WIFI/GPRS/Ethernet)	1 PCS (Optional)

3.3. Tools

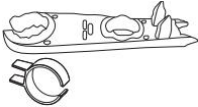
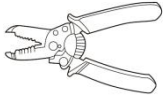
Prepare tools required for installation and electrical connection as following table:

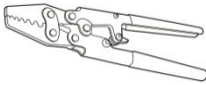
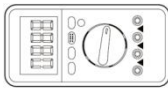
Figure 3-2 Installation tools

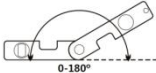
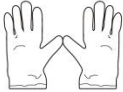
No	Tool	Description	Function
1		Hammer Drill Recommend drill @ 80mm	Used to drill holes on the wall
2		Screwdriver	Use to tighten and loosen screws when installing AC power cable Use to remove AC connectors from the product

3		Removal Tool	Remove PV Connector
4		Wire Stripper	Used to peel cable
5		M6 hexagon wrench	M6 use to uninstall and install the front top cover and down cover
6		Crimping Tool	Use to crimp cable on grid side, load side and CT extensive cable
7		Multimeter	Check grounding cable, PV positive and negative pole
8		Marker	Mark signs
9		Measuring Tape	Measure distance
10		Level	Ensure the rear panel is properly installed
11		ESD gloves	Installer wear when installing product
12		Safety goggles	Installer wear when installing product
13		Mask	Installer wear when installing product

3.4. Determining the Installation Position

Select an appropriate location to install the product to make sure the inverter can work in a high efficiency condition. When selecting a location for the inverter, consider the following:

Note: install vertical or backward tilt within $0-15^{\circ}$, Do not install forward or upside down!

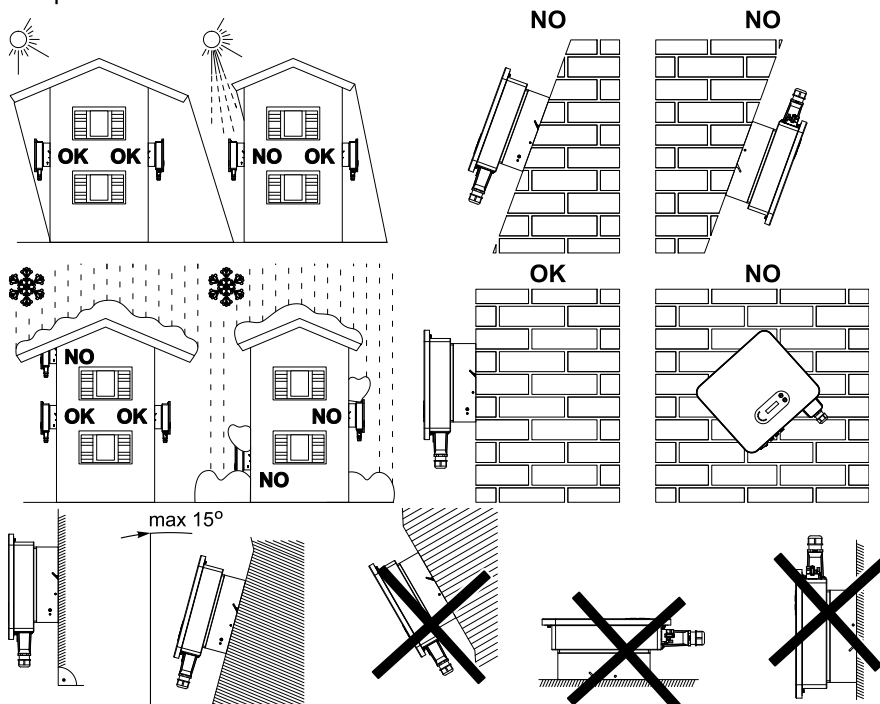

Figure 3-1 Installation Position Selection

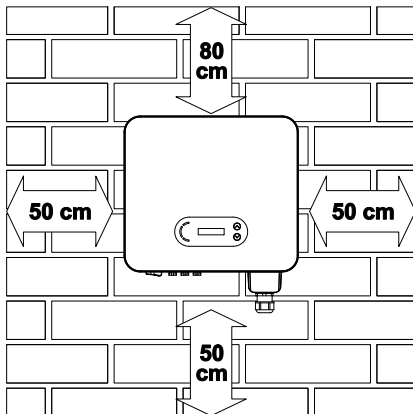

Figure 3-2 Clearance for single inverter

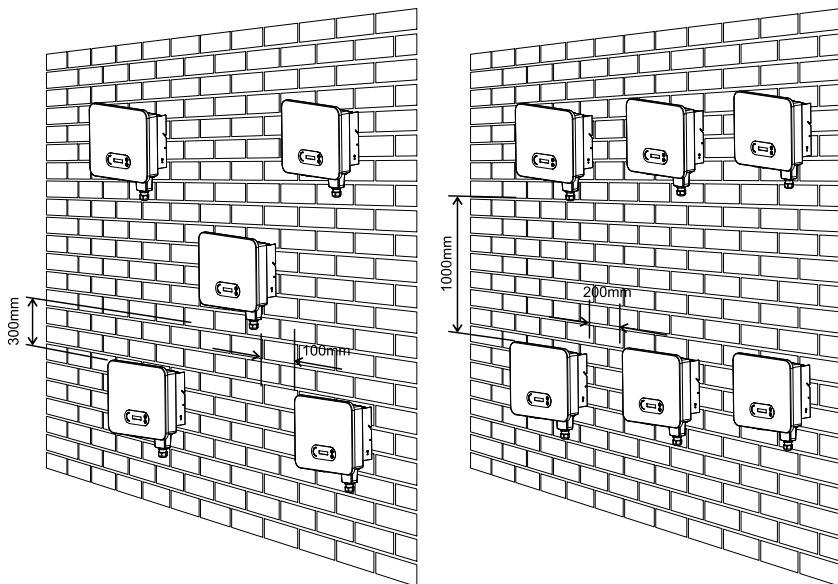

Figure 3-3 Clearance for multiple inverters

3.5. Moving of inverter

Unload the inverter from package, horizontally move to the install position. When open the package, at least two operators insert the hands to the back of heat sink part.

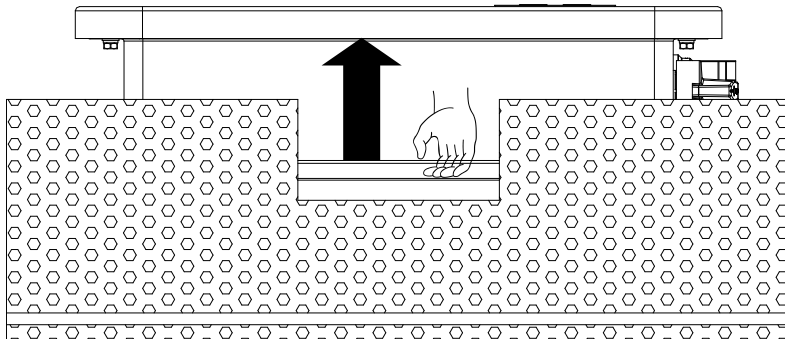

Figure 3-5 Move inverter from package (1)

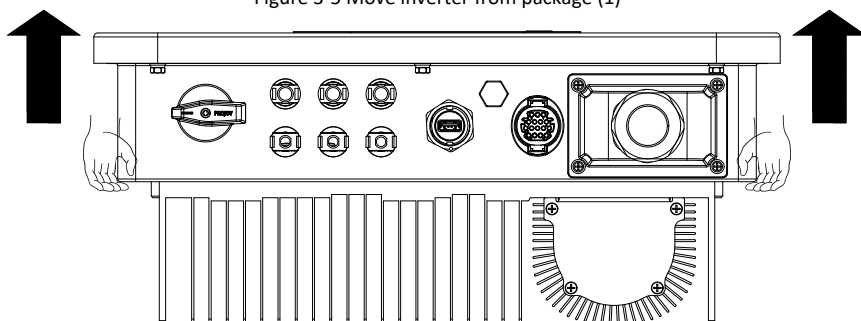

Figure 3-6 Move inverter from package (2)



Attention

Inverter is heavy, attention to keep the balance when lift the inverter. Dropped while being transported may cause injuries.

Do not put the inverter with wiring terminals contacting the floor because the power ports and signal ports are not designed to support the weight of the inverter

When place inverter on the floor, put it above foam or paper to avoid the damage of the shell of inverter.

3.6. Installation

Step 1: Placed the rear panel on the mounting wall, determine the mounting height of the bracket and mark the mounting poles accordingly. Drilling holes by using Hammer Drill, keep the hammer drill perpendicular to the wall and make sure the position of the holes should be suitable for the expansion bolts.

Step 2: Align the rear panel with the hole position, and drive the M6 expansion bolt in.

Step 3: Fix the rear panels on the wall by tightening the M6*80 Hexagon screws

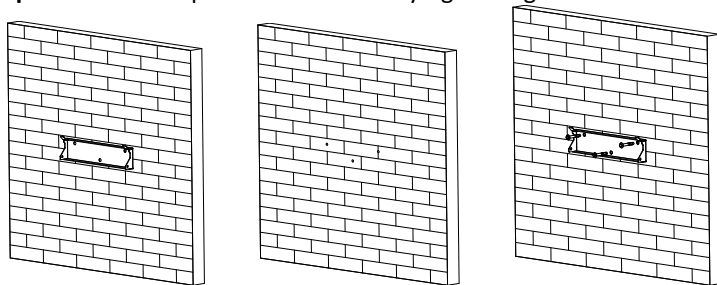

Figure 3-7 Installation instruction (1)

Step 4: Lift the inverter and hang it on the rear panel, and fixing both side of inverter with M6 screw (accessories).

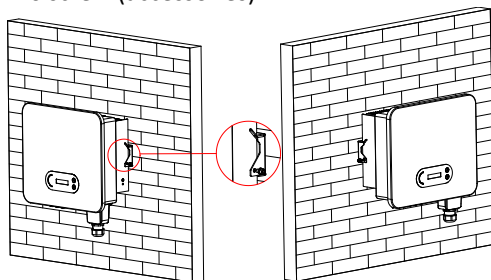

Figure 3-8 Installation instruction (2)



4. Electrical Connection

Outlines of this Chapter

This section introduces the electrical connection for the product. Please read the information carefully, it may helpful to understand the grounding wiring, DC input connection, AC output connection and communication connection.

Caution:

Before performing electrical connections, ensure the DC switch is OFF and AC circuit breaker is OFF. Waiting 5 minutes for the capacitor to be electrically discharged.

	Installation and maintenance should be done by certified electrical engineer
Attention	
	Before the electrical connection, use opaque material to cover the PV modules or disconnect PV string DC switch. PV arrays will produce dangerous voltage if it is exposure under sun
Danger	
	For this product, the open circuit voltage of PV strings should not greater 1100V
Note	

The connected panel must meet the standard IEC61730A.

String Model	IscPV(maximum)	Maximum output current (A)
SOFAR 3.3KTLX-G3	22.5A/22.5A	5A
SOFAR4.4KTLX-G3	22.5A/22.5A	6.7A
SOFAR 5KTLX-G3-A	22.5A/22.5A	7.6A
SOFAR5.5KTLX-G3	22.5A/22.5A	8.3A
SOFAR 6.6KTLX-G3	22.5A/22.5A	10A
SOFAR 8.8KTLX-G3	22.5A/22.5A	13.3A

SOFAR 8.8KTLX-G3-A	22.5A/45A	13.3A
SOFAR 10KTLX-G3-A	22.5A/45A	15.2A
SOFAR 11KTLX-G3	22.5A/22.5A	16.7A
SOFAR 11KTLX-G3-A	22.5A/45A	16.7A
SOFAR 12KTLX-G3	22.5A/45A	20A

Note: In the above table, the first value of I_{scPV} is for MPPT1, the second value of I_{scPV} is for MPPT2.

4.1. Electrical Connection

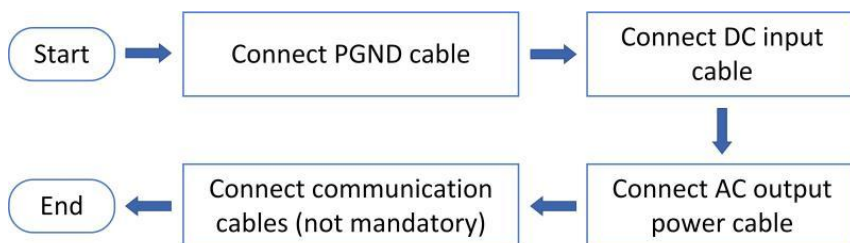



Figure 4-1 Flowchart for connecting cables to the inverter

4.2. Grounding Connection (PE)

Connect the inverter to the grounding electrode using ground cable

	<p>SOFAR 3.3~12KTLX-G3 is a transformerless inverter which requires the positive pole and negative pole of the PV array are NOT grounded. Otherwise, it will cause inverter failure. In the PV system, all non-current-carrying metal parts (such as mounting frame, combiner box enclosure, etc.) should be connected to earthed.</p>
Note	

Preparation: prepare the grounding cable (recommend greater than 2.5mm² yellow-green outdoor cable)

Procedure:

Step 1: Remove the insulation layer with an appropriate length using a wire stripper shown as figure 4-2)

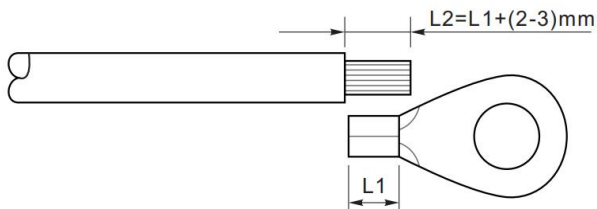

Figure 4-2 Grounding connection instruction (1)

Note: the length of L2 should 2~3mm higher than L1

Step 2: Insert the exposed core wires into the OT terminal and crimp them by using a crimping tool, as shown as figure 5.3. Recommend using OT terminal: OT-M6, Cable: $\geq 6\text{mm}^2$

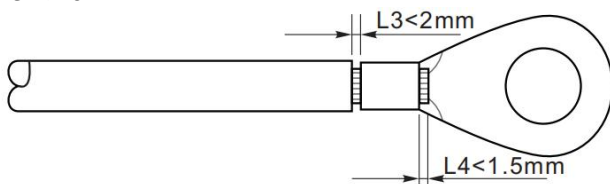
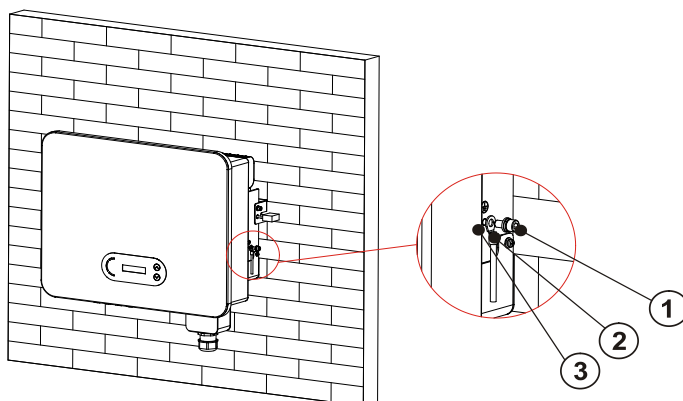

Figure 4-3 Grounding connection instruction (2)

Note 1: L3 is the length between the insulation layer of the ground cable and crimped part. L4 is the distance between the crimped part and core wires protruding from the crimped part.

Note 2: The cavity formed after crimping the conductor crimp strip shall wrap the core wires completely. The core wires shall contact the terminal closely.

Step 3: Tighten the OT terminal by using M6 screw. Recommend torque is 5N.m



1. M6 screw 2. OT terminal 3. threaded hole

Figure 4-4 Inverter external grounding instruction diagram

4.3. Connect grid side of inverter (AC-Output)

SOFAR 3.3~12KTLX-G3 connect to utility grid by using AC power cable. The AC connection must meet the requirement of local grid operator

	Ban multiple Inverters use one circuit breaker Ban connect loads between inverter and circuit breaker
Caution	

Must use five core outdoor cable, the recommend AC cable and Residual current breaker (RCB) as below table:

Model	Cross section area of Cu cable (mm ²)	Muti-core outdoor cable (mm)	AC Circuit Breaker specification
SOFAR 3.3KTLX-G3	2~3, recommend 2.5	18~25	16A/230V/3P current leakage protection 0.1A
SOFAR 4.4KTLX-G3	2~3, recommend 2.5	18~25	16A/230V/3P current leakage protection 0.1A
SOFAR 5KTLX-G3-A	3~4, recommend 3	18~25	16A/230V/3P current leakage protection 0.1A
SOFAR 5.5KTLX-G3	3~4, recommend 3	18~25	16A/230V/3P current leakage protection 0.1A
SOFAR 6.6KTLX-G3	3~4, recommend 4	18~25	20A/230V/3P current leakage protection 0.1A
SOFAR 8.8KTLX-G3-A	4~6, recommend 5	18~25	25A/230V/3P current leakage protection 0.1A
SOFAR 8.8KTLX-G3	4~6, recommend 5	18~25	25A/230V/3P current leakage protection 0.1A
SOFAR 10KTLX-G3-A	4~6, recommend 5	18~25	25A/230V/3P current leakage protection 0.1A
SOFAR 11KTLX-G3-A	5~7, recommend 6	18~25	32A/230V/3P current leakage protection 0.1A
SOFAR 11KTLX-G3	5~7, recommend 6	18~25	32A/230V/3P current leakage protection 0.1A
SOFAR 12KTLX-G3	5~7, recommend 6	18~25	32A/230V/3P current leakage protection 0.1A

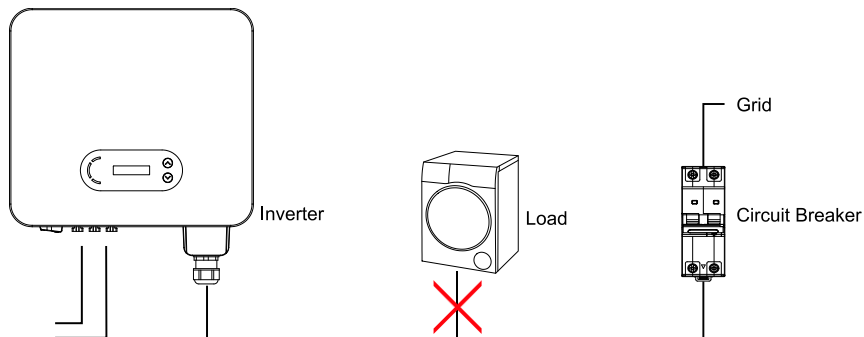

Figure 4-5 Incorrect connection between load and inverter

The resistance at connection point must less than $2\ \Omega$. In case to have a properly anti-islanding function, please choose the high-quality PV cable and ensure the power loss is less than 1%. Meanwhile, the inverter AC side to grid connection point must less than 100m. the relation between cable length, cross section area and power loss as below:

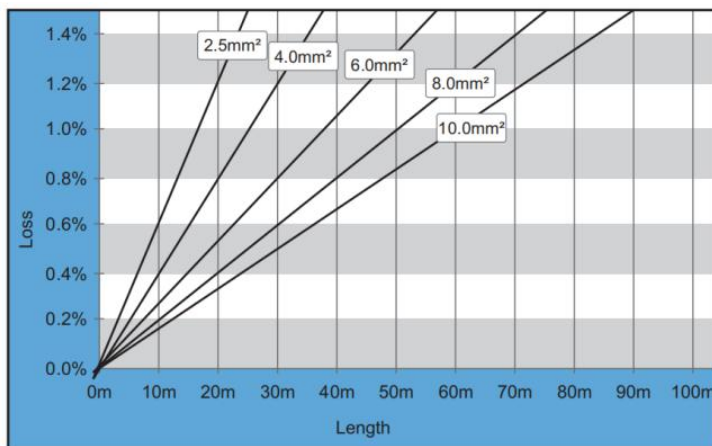

Figure 4-6 relation between cable length, cross section area and power loss

The AC output terminal of this product is equipped with high current 5-core terminal block and customized AC output waterproof cover, which can meet the IP65 level requirements after installation. AC cable need customer self connect:

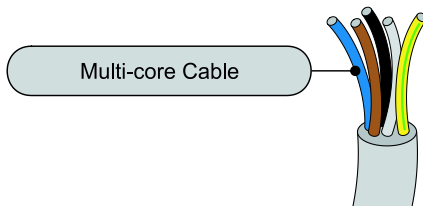

Figure 4-7 SOFAR 3.3~12KTLX-G3 Multi-core Cable picture

Wiring Procedure as following:

Step 1: Remove the AC waterproof cover screw with a screwdriver, and take out the stopper in the PG waterproof joint.

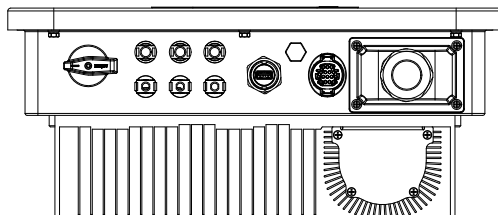
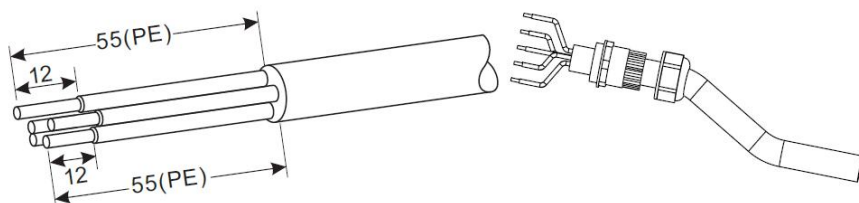

Figure 4-8 Removing AC waterproof cover diagram

Step 2: Select the appropriate cable diameter according to table 4-1, process the cable according to the following picture size requirements, and then pass through PG waterproof joint;



R type terminal,
RNBL5-4 (10-12awg).

Insulating sleeve,
terminal shall not be exposed.

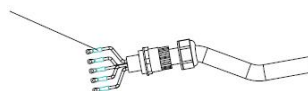
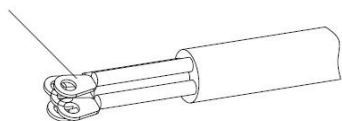

Figure 4-9 AC cable connection instruction diagram (1)

Step 3: After assembling the PG waterproof connector, connect the cable to the AC terminal block L1, L2, L3, N, PE contacts, and fasten them ($1\sim 1.6\text{ N}\cdot\text{m}$). Tighten the lock nut of PG terminal clockwise ($5\sim 5.5\text{ N}\cdot\text{m}$).

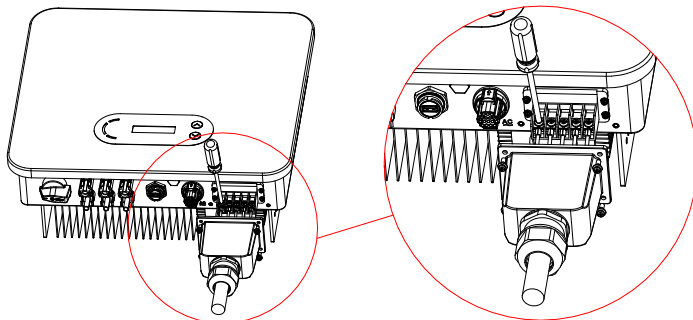

Figure 4-10 AC cable connection instruction diagram (2)

4.4. Connect PV side of inverter (DC-Input)

Table 4.2 Recommend DC input cable size (maximum tolerance voltage $\geq 1100\text{V}$ PV cable)

Copper cable cross section area (mm^2)	Cable OD (mm)
4~6.0	6.0~9.0

Figure 5-2 Recommend DC cable size

Step1: Find the metal contact pins in the accessories bag, connect the cable according to below diagram (1.Positive cable, 2. negative cable);

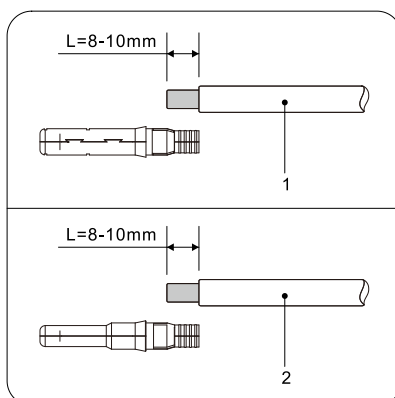

Figure 4-11 DC cable connection (1)

Step 2: Crimp the PV metal contact pin to the striped cable using a proper crimping pliers;

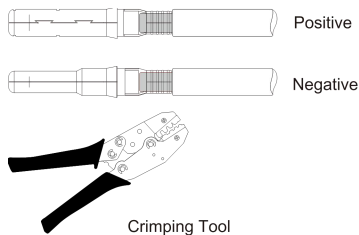

Figure 4-12 DC cable connection(2)

Step 3: Insert wire into the connector cap nut and assemble into the back of male or female plug, When you heard a “click”, the pin tact assembly is seated correctly. (3. Positive Connector, 4. negative connector);

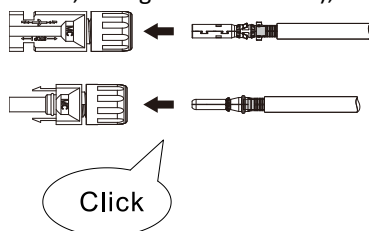

Figure 4-13 DC cable connection(3)

Step 4: Measure PV voltage of DC input with multimeter, verify DC input cable polar and connect DC connector with inverter until hearing a slight sound indicated connection succeed.

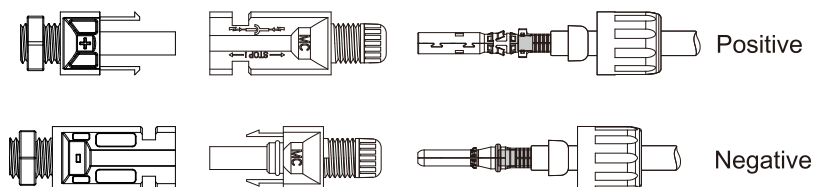

Figure 4-14 DC cable connection(4)

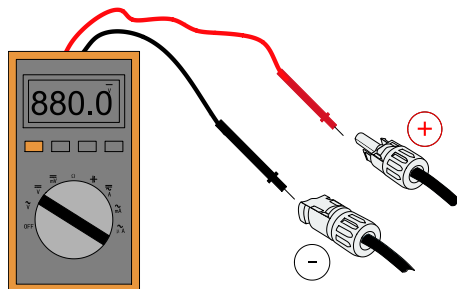



Figure 4-15 Use a multimeter to check the positive and negative electrodes

Note : Please use multimeter to make sure the PV array positive pole and negative pole!

Dealing: If need to remove the PV connector from inverter side, please use the Removal Tool as below diagram, move the connector gently.

 NOTE	<p>Before, moving the positive and negative connector, please make sure "DC Switch" is on OFF position.</p>
--	---

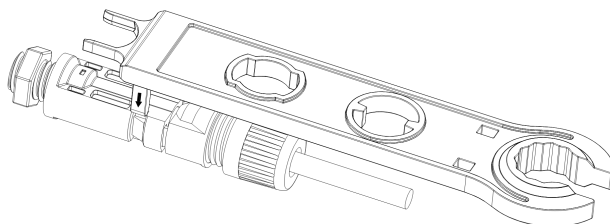



Figure 4-16 Removal DC connector

4.5. Communication Connection

 Note	<p>When layout the wiring diagram, please separate the communication wiring and power wiring in case the signal be affected.</p>
--	--

3.3~12KTLX-G3 inverter has one USB Port and one COM Port, as shown in the following figure.

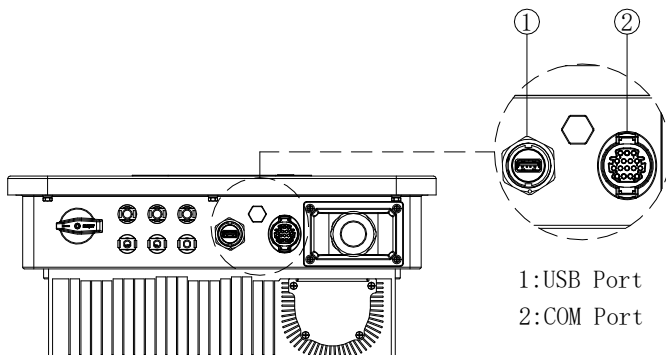

Figure 4-17 Communication connection Port

4.5.1. USB Port

Port Description:

USB port	USB flash disk access	Use for updating the software
	USB acquisition stick (WIFI or Ethernet) access	Use for remote data acquisition and upgrading of inverter

Procedure:

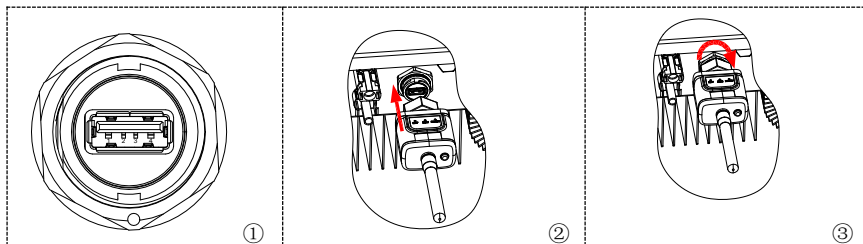

For details, please refer to the user manual of USB acquisition stick.

4.5.2. COM—Multi function communication port

Figure 4-18 Recommend COM cable size

Name	Type	Outer diameter (mm)	Area (mm ²)
RS485 Communication	Outdoor shielded twisted pair meets	2 or 3core: 4~8	0.25~1

Wire	local standards		
------	-----------------	--	--

Port Description:

PIN	Define	Function	Note
1	RS485A	RS485 signal+	Wire connection monitoring or multiple inverter monitoring
2	RS485A	RS485 signal+	
3	RS485B	RS485 signal-	
4	RS485B	RS485 signal-	
5	Electric meter RS485A	Electric meter RS485 signal+	Wire connection Electric meter
6	Electric meter RS485B	Electric meter RS485 signal-	
7	GND.S	Communication ground	As RS485 signal ground or DRMS port ground
8	DRM0	Remote shut down	DRMS port
9	DRM1/5	DRMS port logical IO	
10	DRM2/6		
11	DRM3/7		
12	DRM4/8		
13-16	Blank PIN	N/A	N/A

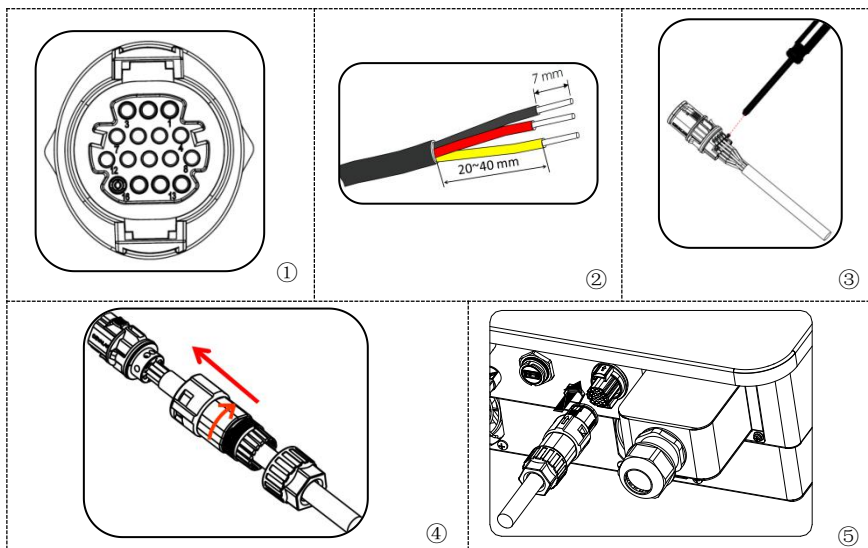
Procedure:

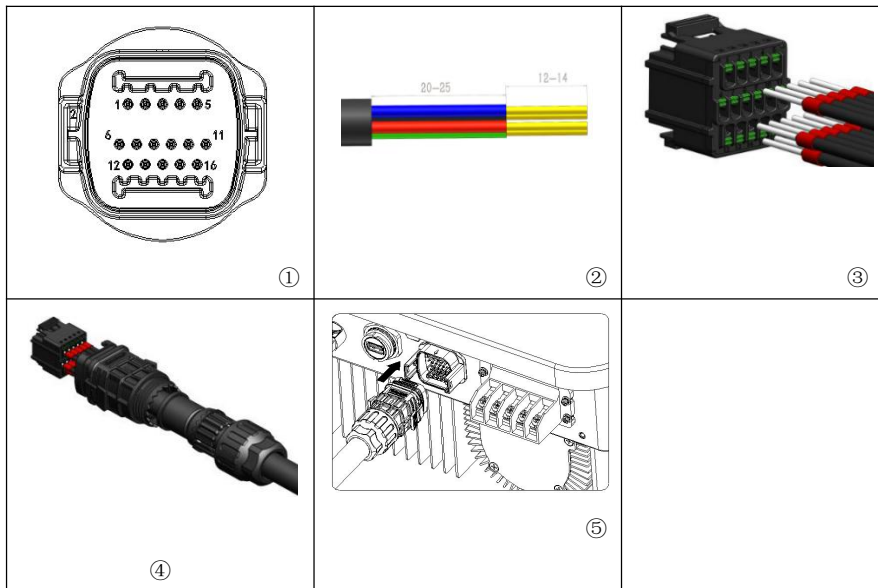
Or



4.5.3. Communications Port Description

This topic describes the functions of the RS485 and WIFI.

RS485

By RS485 interface, transfer the inverter power output information, alarm information, operation state to the PC terminal or local data acquisition device, then uploaded to the server.

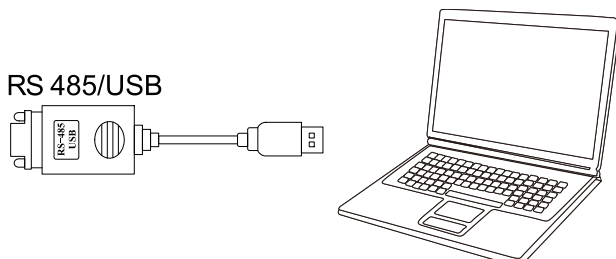

Figure 4-18 Picture of the RS485/USB converter and PC terminal

If only one SOFAR 3.3~12KTLX-G3 is used, use a communication cable, refer to **section 4.5.2** for COM pin definition, and choose either of the two RS485 ports.

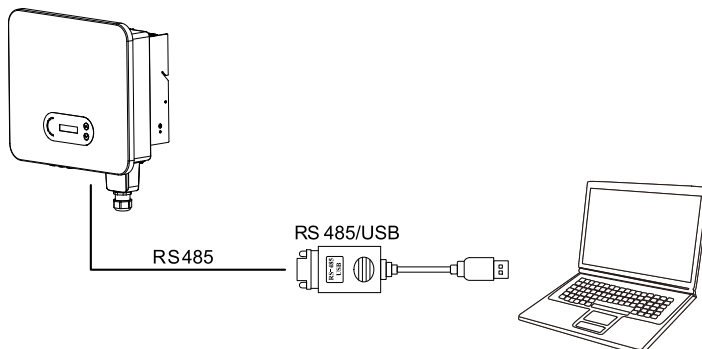

Figure 4-19 A single SOFAR 3.3~12KTLX-G3 connecting communications

If multiple SOFAR 3.3~12KTLX-G3 are used, connect all SOFAR 3.3~12KTLX-G3 in daisy chain mode over the RS485 communication cable. Set different Modbus address (1~31) for each inverter in LCD display.

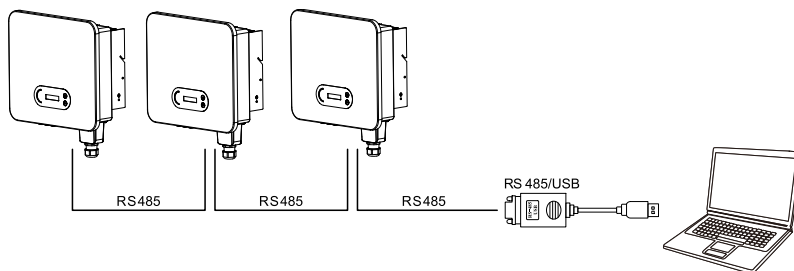

Figure 4-20 Multi SOFAR 3.3~12KTLX-G3 connecting Communications

Register remote monitoring of SOFAR 3.3~12KTLX-G3 at its relevant website or APP according to monitoring device SN.

WIFI / Ethernet

By the USB acquisition stick (WIFI / Ethernet), transfer the inverter power output information, alarm information, operation state to the PC terminal or local data acquisition device, then uploaded to the server. Register remote monitoring of SOFAR 3.3~12KTLX-G3 at its relevant website or APP according to monitoring device SN.

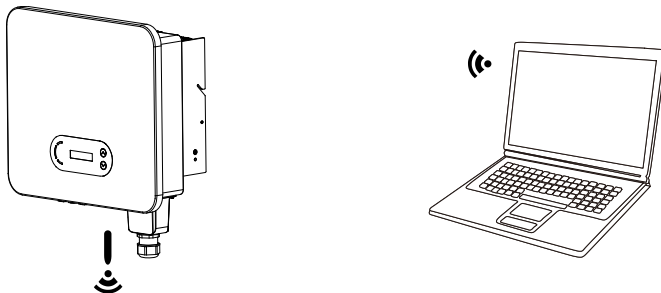

Figure 4-21 Connect one USB acquisition stick (WIFI version) to wireless router

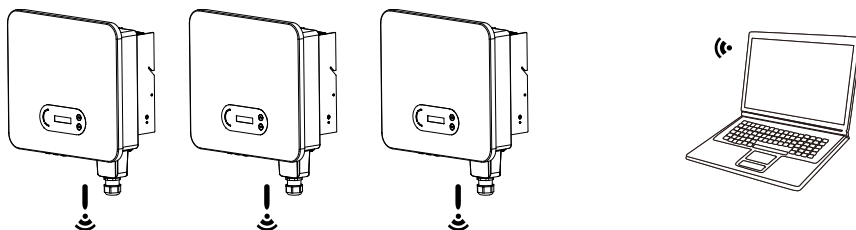

Figure 4-22 Connect multiple USB acquisition stick (WIFI version) to wireless router



Note

- The length of the RS485 communication cable should be less than 1000 m.
- The length of the WIFI communication cable should be less than 100 m.
- If multiple SOFAR 3.3~12KTLX-G3 are connected to the monitoring device over an RS485/USB converter, a maximum of 31 inverters can be connected in a daisy chain.

5. Commissioning of inverter

Outlines this Chapter

Introduce SOFAR 3.3~12KTLX-G3 safety inspection and start processing

5.1. Cable Connection Inspection

 Attention	<p>For first time operation, check the AC voltage and DC voltage are within the acceptable range</p>
---	--

AC grid connection

Use multimeter to confirm that three lines and PE line are connect correctly. DC pv connection

Use multimeter to confirm that positive pole and negative pole of PV strings, and the Voc of each string is lower than the inverter max DC input.

5.2. Start Inverter

Step 1: Turn ON the DC switch.

Step 2: Turn ON the AC circuit breaker.

When the DC power generated by the solar array is enough, the SOFAR 3.3~12KTLX-G3 inverter will start automatically. Screen showing “normal” indicates correct operation.

NOTE 1: Choose the correct country code. (refer to section 6.3 of this manual)

NOTE 2: Different distribution network operators in different countries have different requirements regarding grid connections of PV grid connected inverters.

Therefore, it's very important to make sure that you have selected the correct country code according to requirements of local authority. Please consult qualified electrical engineer or personnel from electrical safety authorities about this.

Shenzhen SOFARSOLAR Co., Ltd. is not responsible for any consequences arising out of incorrect country code selection.

If the inverter indicates any fault, please refer to Section 7.1 of this manual —
— trouble shooting for help.

6. Operation interface

Outlines of this chapter

This section introduces the display, operation, buttons and LED indicator lights of SOFAR 3.3~12KTLX-G3 Inverter.

6.1. Operation and Display Panel

Buttons and Indicator lights

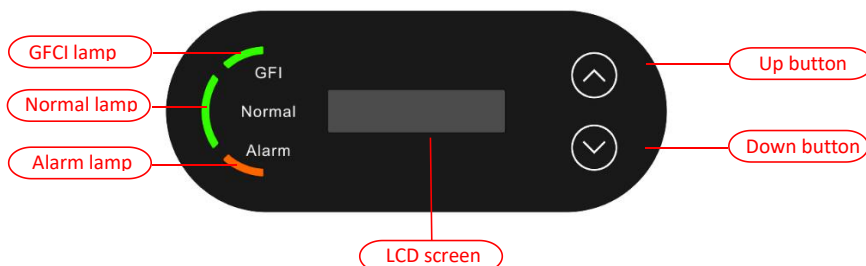

Button:

- “^” Short press UP button = go up
- “^” Long press UP button = exit menu or current interface
- “v” Short press DOWN button = go down
- “v” Long press DOWN button = enter menu or current interface

Indicator Lights:

- “GFI” Red light ON = GFCI faulty
- “Normal” Green light flashing = counting down or checking
- “Normal” Green light ON = Normal
- “Alarm” Red light ON= recoverable or unrecoverable faulty

6.2. Standard Interface

LCD interface indicated inverter status, alarm information, communication connection, PV input current and voltage, grid voltage, current and frequency, today generation, total generation.

Inverter working status, PV 1 input voltage and current

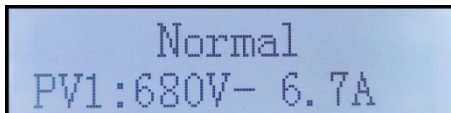

Normal
PV1:680V- 6.7A

Inverter working status, PV 2 input voltage and current

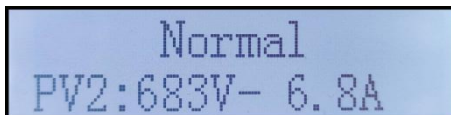

Normal
PV2:683V- 6.8A

Inverter working status, PV generated power

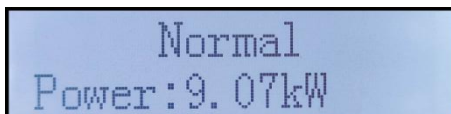

Normal
Power:9.07kW

Inverter working status, today generated electricity

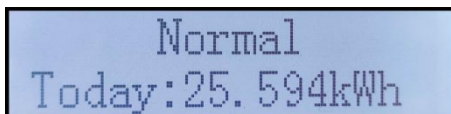

Normal
Today:25.594kWh

Inverter working status, total generated electricity

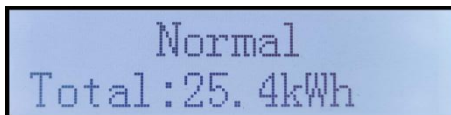

Normal
Total:25.4kWh

Inverter working status, grid voltage and current

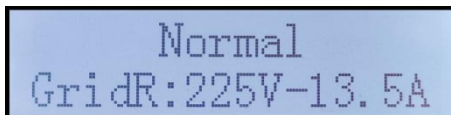

Normal
GridR:225V-13.5A

Normal
GridS:228V-13.4A

Normal
GridT:224V-13.4A

Inverter working status, grid voltage and frequency

Normal
Grid:226V-50.0Hz

Inverter working status, USB status

Normal
Power:9.07kW 

Inverter faulty alarm

GridUVP
Power:0.00kW

When control board successfully connected with communication board, the LCD display the current state of the inverter, display as shown in the figure below.

Wait 3 s
Power:0.00kW

Check
Power:0.00kW

Normal
Today:25.594kWh

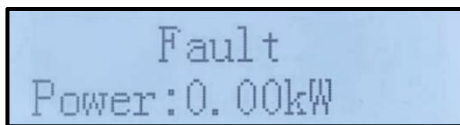

Inverter states includes: wait, check, normal and fault

Wait: Inverter is waiting to Check State when reconnect the system. In this state, grid voltage value is between the max and min limits and so on; If not, Inverter will go to Fault State or Permanent State.

Check: Inverter is checking isolation resistor, relays, and other safety requirements. It also does self-test to ensure inverter software and hardware are well functional. Inverter will go to Fault State or Permanent State if any error or fault occurs.

Normal: Inverter enter to Normal State, it is feeding power to the grid; inverter will go to Fault State or Permanent state if any error or fault occurs.

Fault: Fault State: Inverter has encountered recoverable error. It should recover if the errors disappear. If Fault State continues; please check the inverter according error code.

When the control board and communication board connection fail, the LCD display interface as shown in the figure below.

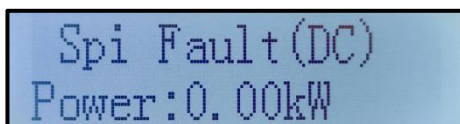

6.3. Main Interface

Long press the down button under standard interface to enter into main interface, Main interface including below information:

Normal	-----Long press DOWN button
	1.Enter Setting
	2.Event List
	3.SystemInfo
	4.Display Time
	5.Software Update

(A) Enter setting Interface as below :

1. Enter Setting	-----Long press DOWN button	
	1.Set time	9.Set Language
	2.Clear Energy	10.Set AntiReflux
	3.Clear Events	11.Logic Interface
	4.Set Country	12.IV Curve Scan
	5.On-Off Control	13.PCC Select
	6.Set Energy	14.Reflux Mode
	7.Set Address	15.Autotest Fast
	8.Set Input mode	16.Autotest STD

Long press the button to Enter the main interface of "1. Enter Setting" and long press to enter the setting menu. You can select the content you want to set by short pressing the button.

Note1: Some settings need to enter the password (the default password is 0001), when entering the password, short press to change the number, long press to confirm the current number, and long press after entering the correct password. If "password error, try again" appears, you will need to re-enter the correct password.

1. Set Time

Set the system time for the inverter.

2. Clear Energy

Clean the inverter of the total power generation.

3. Clear Events

Clean up the historical events recorded in the inverter.

4. Country Code

Long press button, enter interface, save the specific file into USB and insert USB into inverter communication port

5. On-Off Control

Inverter on-off local control.

6. Set Energy

Set the total power generation. You can modify the total power generation through this option.

7. Set address

Set the address (when you need to monitor multiple inverters simultaneously), Default 01.

8. Set Input mode

SOFAR 3.3~12KTLX-G3 has 2 MPPT circuit, each MPPT circuit can work interdependently, or divided into parallel mode. User can change the setting according to the configuration

9. Set Language

Set the inverter display language.

10. Set AntiReflux

Enable or disable Reflux. It is use for inverter generation and output limit control functions, but requires the use of external measuring equipment to obtain grid information.

11. Logic interface

Enable or disable logical interfaces. It is use for below standard Australia (AS4777), Europe General (50549), German (4105)

12. IV Curve Scan

Shadow scanning, when the component is blocked or abnormal, causing multiple power peaks, by enabling this function, the peak point of maximum power can be tracked.

13. PCC Select

The function is divided into two options: PCC Meter and PCC ARPC, the first one is the default usage for SOFAR 3-15KTLX-G3. Refer to <6.5 Smart meter instruction in this manual for specific operation methods.

14. Reflux Mode

The function is divided into three options: CTR Totalpower, CTR Phasepower and CTR SellingPower, the first one is the default usage for SOFAR 3-15KTLX-G3. Refer to <6.5 Smart meter usage in this manual for specific operation methods.

15. Autotest Fast

13.Autotest Fast

OK

Start Autotest	Long press the “ v ” to start
Testing 59.S1...	
↓	Wait
Test 59.S1 OK!	
↓	Wait
Testing 59.S2...	
↓	Wait
Test 59.S2 OK!	
↓	Wait
Testing 27.S1...	
↓	Wait
Test 27.S1 OK!	
↓	Wait
Testing 27.S2...	
↓	Wait
Test 27.S2 OK!	
↓	Wait
Testing 81>S1...	
↓	Wait
Test 81>S1 OK!	
↓	Wait
Testing 81>S2...	
↓	Wait
Test 81>S2 OK!	
↓	Wait
Testing 81<S1...	
↓	Wait
Test 81<S1 OK!	
↓	Wait
Testing 81<S2...	
↓	Wait
Test 81<S2 OK!	
↓	Long press the “ v ”
Auto Test OK!	
↓	Short press the “ v ”
59.S1 threshold 253V 900ms	
↓	Short press the “ v ”
59.S1: 228V 902ms	

↓	Short press the “ v ”
59.S2 threshold 264.5V 200ms	
↓	Short press the “ v ”
59.S2: 229V 204ms	
↓	Short press the “ v ”
27.S1 threshold 195.5V 1500ms	
↓	Short press the “ v ”
27.S1: 228V 1508ms	
↓	Short press the “ v ”
27.S2 threshold 34.5V 200ms	
↓	Short press the “ v ”
27.S2: 227V 205ms	
↓	Short press the “ v ”
81>.S1 threshold 50.5Hz 100ms	
↓	Short press the “ v ”
81>.S1 49.9Hz 103ms	
↓	Short press the “ v ”
81>.S2 threshold 51.5Hz 100ms	
↓	Short press the “ v ”
81>.S2 49.9Hz 107ms	
↓	Short press the “ v ”
81<.S1 threshold 49.5Hz 100ms	
↓	Short press the “ v ”
81<.S1 50.0Hz 105ms	
↓	Short press the “ v ”
81<.S2 threshold 47.5Hz 100ms	
↓	Short press the “ v ”
81<.S2 50.1Hz 107ms	

16. Autotest STD

14.Autotest STD

Long press the “ v ”

The test procedure is same as Autotest Fast, but it's much more time consuming.

(B) Event List:

Event List is used to display the real-time event records, including the total number of events and each specific ID No. and happening time. User can enter Event List interface through main interface to check details of real-time event records, Event will be listed by the happening time, and recent events will be listed in the front. Please refer to below picture. Long press the button and short press the button to turn the page in standard interface, then enter into “2. Event List” interface.

2. Event List	
1. Current event	2. History event
Fault information	001 ID04 06150825 (Display the event sequence number, event ID number, and event occurrence time)

(A) “SystemInfo” Interface as below

3.SystemInfo	-----Long press DOWN button
	1.Inverter Type
	2.Serial Number
	3.Soft Version
	4.Hard Version
	5.Country
	6.Modbus Address
	7.Input Mode

The user enters the main menu by long pressing the DOWN button, short press and turns the page to select menu contents, then long press the button to enter "3. SystemInfo". Turning the page down can select the system information to view.

(B) Display Time

Long press the button and short press the button to turn the page in the standard user interface to enter into “4. Display Time”, then long press the button to display the current system time.

(C) Software Update

User can update software by USB flash disk, SOFARSOLAR will provide the new update software called firmware for user if it is necessary, the user needs to copy the upgrade file to the USB flash disk.

6.4. Updating Inverter Software

SOFAR 3.3~12KTLX-G3 inverter offer software upgrade via USB flash drive to maximize inverter performance and avoid inverter operation error caused by software bugs.

Step 1: turn off AC circuit breaker and DC switch, remove the communication board cover as below figure. If the RS485 line has been connected, please release the waterproof nut first and make sure the communication line is no longer the force. Then remove the waterproof cover.

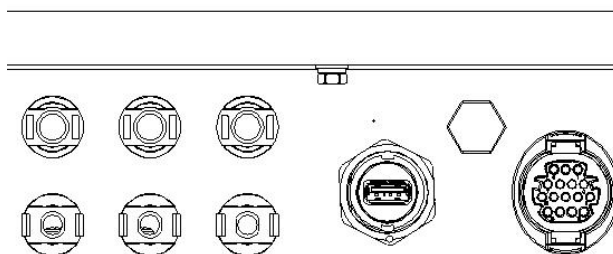

Figure 6-1 Remove communication board cover

Step 2: Insert USB into computer;

Step 3: SOFARSOLAR service team will send the software code to user, after user receive the file, please decompressing file and cover the original file in USB flash drive.

Step 4: Insert USB flash disk into the USB port of inverter.

Step 5: Then turn on DC switch, screen show “recoverable fault” (as AC circuit breaker still open, inverter cannot detect grid power, so it may show “recoverable fault”)

Step 6: Long press “DOWN” button to enter the menu, then short press

“DOWN” button to find "5. Software Update” in the LCD display, long press “DOWN” button to enter input password interface.

Step 7: Input the password, if password is correct, and then begin the update process.

Step 8: System update main DSP, slave DSP and ARM in turns. If main DSP update success, the LCD will display “Update DSP1 Success”, otherwise display "Update DSP1 Fail"; If slave DSP update success, the LCD will display"Update DSP2 Success", otherwise display "UpdateDSP2 Fail".

Step 9: After the update is completed, turn off the DC breaker, wait for the LCD screen extinguish, then recover the communication waterproof and then turn on the DC breaker and AC breaker again, the inverter will enter the running state. User can check the current software version in SystemInfo>>3.SoftVersion.

Note: If screen shows “Communication fail” , “Update DSP1 fail” , “Update DSP2 fail” please turn off the DC switch, wait for the LCD screen turn off, then turn on the DC switch again, then Continue to update from step 5.

6.5. Smart meter instruction

Generation and Export Limit Control functions for the inverter are available but require the use of an external measurement device to obtain grid information.

Note: Meter is supplied separately to the inverter. Please contact your distributor to order a meter.

Step 1: In the standard interface, Long press DOWN button to enter the "1. Enter Setting" interface, and then Short press DOWN button to enter "13.PCC Select" interface, long press DOWN button to confirm the input password (initial password is 0001), press up or down to find "PCC Meter", and then long press DOWN button to display "14.Reflux Mode". In the "Anti-Reflux Mode" (14.Reflux Mode) interface, select one of the CTR Totalpower, CTR Phasepower, or CTR SellingPower by press DOWN button, ."success" will be displayed if setting successfully.

Step 2: In the standard interface, Long press DOWN button to enter the "1. Enter Setting" interface, and then Short press DOWN button to enter the "10. Set AntiReflux" interface, long press DOWN button to confirm the input password (initial password is 0001), the power setting can be entered by pressing the UP or DOWM button to find the "Reflux Enable", and Long press the DOWM button for confirmation; Press the up or DOWM button to change the size of the value, and then long press the DOWM button to complete the input of the current value, and enter the setting of the next value. After setting the fourth number, long press the DOWM button to confirm, the value selection of antiReflux power can be completed.

Note:Explanation of professional terms:

CTR Totalpower:The Sum of three-phase selling power of the connection point
 \leq The set Reflux power

CTR Phasepower:The sum of the three phase power vector of the connection point
= The set Reflux power

CTR SellingPower:The selling power of any phase of the system connection point
 \leq The set Reflux power /3

Selling electricity: sending electricity to the grid

Buy electricity: take energy from the grid

Anti-Reflux: limit the energy sent to the grid

Positive power: the power purchased

Negative power: the power of selling electricity

7. Trouble shooting and maintenance

7.1. Troubleshooting

This section describes the potential errors for this product. Please read carefully for the following tips when doing the troubleshooting:

- 1) Check the warning message or faulty codes on the inverter information panel
- 2) If not any error code display on the panel, please check the following lists:
 - Is inverter be installed in a clean, dry, ventilated environment?
 - Is the DC switch turn off?
 - Are the cable cross section area and length meet the requirement?
 - Are the input and output connection and wiring in good condition?
 - Are the configuration settings correctly for the particular installation?

This section contains the potential errors, resolution steps, and provide users with troubleshooting methods and tips

The process to check the event list can refers to Manual Chapter 7.3 (B)

List 8-1 Even list

Even List ID	Event List Name	Even List Description	Even Reason & Solution
ID01	GridOVP	The power grid voltage is too high	If the alarm occurs occasionally, the possible cause is that the electric grid is abnormal occasionally. inverter automatically returns to normal operating status when the electric grid's back to normal.
ID02	GridUVP	The power grid voltage is too low	If the alarm occurs frequently, check whether the grid voltage/frequency is within the acceptable range. If no, contact technical support. If yes, check the AC circuit breaker and AC wiring of the inverter.

ID03	GridOPF	The power grid frequency is too high	If the grid voltage/frequency is within the acceptable range and AC wiring is correct, while the alarm occurs repeatedly, contact technical support to change the grid over-voltage, under-voltage, over frequency, under-frequency protection points after obtaining approval from the local electrical grid operator.
ID04	GridUFP	The power grid frequency is too low	
ID05	GFCIFault	GFCI Fault	If the fault occurs occasionally, the possible cause is that the external circuits are abnormal occasionally. inverter automatically returns to normal operating status after the fault is rectified. If the fault occurs frequently and lasts a long time, check whether the insulation resistance between the PV array and earth(ground) is too low, then check the insulation conditions of PV cable.
ID06	OVRT	OVRT faulty	There are internal faults of inverter, turn OFF the "DC switch", wait for 5 minutes, then turn ON the "DC switch". Check whether the fault is rectified. If no, please contact technical support.
ID07	LVRT	LVRT faulty	
ID08	IslandFault	Islanding faulty	
ID09	GridOVInstant1	Grid instantaneous voltage too high 1	
ID10	GridOVInstant2	Grid instantaneous voltage too high 2	
ID11	VGridLineFault	Grid Line voltage Faulty	
ID12	InvOVP	Inverter overvoltage	
ID17	HwADFaultGrid	The grid current sampling error	
ID18	HwADFaultDCI	The DCI sampling error	
ID19	HwADFaultVGrid(DC)	Grid voltage sampling faulty (DC side)	
ID20	HwADFaultVGrid(AC)	Grid voltage sampling faulty (AC side)	
ID21	GFCIDeviceFault(DC)	Current leakage sampling (DC side)	There are internal faults of inverter, turn OFF the "DC switch", wait for 5 minutes, then turn ON the "DC switch". Check whether the fault is rectified. If no, please contact technical support.
ID22	GFCIDeviceFault(AC)	Current leakage sampling (AC side)	
ID23	HwADFaultdcBranch	Current Branch sampling faulty	

ID24	HwADFaultI dc	DC input current sampling faulty	
ID29	ConsistentF ault_GFCI	The GFCI sampling value between the master DSP and salve DSP is not consistent	
ID30	ConsistentF ault_Vgrid	The Grid voltage sampling value between the master and salve is not consistent	
ID31	ConsistentF ault_DCI	3 lines' DCI consistency error	There are internal faults of inverter, turn OFF the “DC switch”, wait for 5 minutes, then turn ON the “DC switch”. Check whether the fault is rectified. If no, please contact technical support.
ID33	SpiCommFa ult(DC)	SPI Communication Faulty (DC side)	
ID34	SpiCommFa ult(AC)	SPI Communication Faulty (AC side)	
ID35	SChip_Fault	Chip Faulty (DC side)	
ID36	MChip_Faul t	Chip Faulty (AC side)	
ID37	HwAuxPow erFault	Auxiliary power fault	
ID41	RelayFail	Relay faulty	
ID42	IsoFault	Low isolation faulty	Please check whether the resistance to ground of PV string is too low and whether the insulation of PV cable is damaged. If the use method is not ruled out, please contact the new energy customer service of Capital Airlines.
ID43	PEConnectF ault	Ground faulty	
ID44	PvConfigErr or	Input mode incorrect	
ID45	CT Disconnect	CT Fault	Please check the wiring of PV string, whether each PV input is independent. If the use method is not ruled out, please contact the new energy customer service of Capital Airlines.
ID46	ReversalCon nection	Input reverse connection error	
ID47	Reserved	Reserved	
ID48	SNTypeFaul t	SN doesn't match Type	
			It is internal fault of inverter.

ID49	Reserved	Reserved	<p>Ensure the installation position and installation method</p> <p>meet the requirements of this user manual. Check whether the ambient temperature of the installation position exceeds the upper limit. If yes, improve ventilation to decrease the temperature. Check whether the inverter has dust and dust, whether there are foreign matters blocking the fan at the air inlet. If so, please improve the ventilation and heat dissipation of the environment. It is recommended that the inverter should be cleaned once every half a year.</p>	
ID50	TempFault_HeatSink1	Heat sink1 over-temperature protection		
ID51	Reserved	Reserved		
ID52	Reserved	Reserved		
ID53	Reserved	Reserved		
ID54	Reserved	Reserved		
ID55	Reserved	Reserved		
ID57	TempFault_Env1	environment temperature1 protection		
ID58	Reserved	Reserved		
ID59	TempFault_Inv1	Model 1 over-temperature protection		
ID60	Reserved	Reserved		
ID61	Reserved	Reserved		
ID65	VbusRmsUnbalance	Unbalanced RMS value of bus voltage		<p>There are internal faults of inverter, turn OFF the "DC switch", wait for 5 minutes, then turn ON the "DC switch". Check whether the fault is rectified. If no, please contact technical support.</p>
ID66	VbusInstantUnbalance	Unbalanced instantaneous value of bus voltage		
ID67	BusUVP	Bus undervoltage during grid connection	<p>If the configuration of the PV array is correct, could be the sun irradiation is too low. Once sun irradiation back to normal, inverter will work back normal</p>	
ID68	BusZVP	Bus voltage is low	<p>There are internal faults of inverter, turn OFF the "DC switch", wait for 5 minutes, then turn ON the "DC switch". Check whether the fault is rectified. If no, please contact technical support.</p>	
ID69	PVOVP	PV overvoltage		
ID70	Reserved	Reserved		
ID71	LLCBusOVP	LLCBUS overvoltage		

ID72	SwBusRmsOVP	Inverter bus voltage overvoltage software	
ID73	SwBusInstantOVP	Inverter bus voltage instantaneous value overvoltagesoftware	
ID81	Reserved	Reserved	There are internal faults of inverter, turn OFF the “DC switch”, wait for 5 minutes, then turn ON the “DC switch”. Check whether the fault is rectified. If no, please contact technical support.
ID82	DciOCP	Dci overcurrent faulty	
ID83	SwOCPInstant	Output instantaneous current protection	
ID84	SwBuckBoostOCP	BuckBoost software overcurrent	
ID85	SwAcRmsOCP	Output RMS current protection	
ID86	SwPvOCPInstant	PV overcurrent software protection	
ID87	IpvUnbalance	PV parallel unbalance	
ID88	IacUnbalance	Output current unbalance	
ID89	AFCIFault	Arc Fault	
ID97	HwLLCBusOVP	LLC hardware overvoltage	
ID98	HwBusOVP	Inverter bus hardware overvoltage	
ID99	HwBuckBoostOCP	BuckBoost hardware overcurrent	
ID100	Reserved	Reserved	
ID102	HwPVOCP	PV hardware overcurrent	
ID103	HwACOCP	AC output hardware overcurrent	There are internal faults of inverter, turn OFF the “DC switch”, wait for 5 minutes, then turn ON the “DC switch”. Check whether the fault is rectified. If no, please contact technical support.
ID110	Overload1	Overload Protection 1	
ID111	Overload2	Overload Protection 2	
ID112	Overload3	Overload Protection 3	

ID113	OverTempDerating	Overtemperature derating	<p>Ensure the installation position and installation method meet the requirements of this user manual.</p> <p>Check whether the ambient temperature of the installation position exceeds the upper limit. If yes, improve ventilation to decrease the temperature.</p> <p>Check whether the inverter has dust and dust, whether there are foreign matters blocking the fan at the air inlet. If so, please improve the ventilation and heat dissipation of the environment. It is recommended that the inverter should be cleaned once every half a year.</p>
ID114	FreqDerating	Frequency derating	<p>If it occurs frequently, please check whether the grid voltage and grid frequency are within the allowable range of the inverter; if not, please contact the customer service of SOFARSOLAR; if yes, please check whether the connection between the circuit breaker at the AC side and the output cable is normal; if the grid voltage and grid frequency are within the allowable range of the inverter, and the AC side wiring is confirmed to be correct, the alarm still appears frequently With the approval of the local power operator, please contact the customer service of new energy of Capital Airlines to modify the protection points of over / under voltage and over / under frequency of inverter grid.</p>
ID115	FreqLoading	Frequency loading	
ID116	VoltDerating	Voltage derating	
ID117	VoltLoading	Voltage loading	
ID124	Reserved	Reserved	
ID125	Reserved	Reserved	<p>There are internal faults of inverter, turn OFF the "DC switch", wait for 5 minutes, then turn ON the "DC switch". Check whether the fault is rectified. If no, please contact technical support.</p>
ID129	unrecoverHwAcOCP	Output overcurrent hardware permanent fault	
ID130	unrecoverBusOVP	Bus overvoltage permanent fault	
ID131	unrecoverHwBusOVP	Bus overvoltage hardware permanent fault	<p>There are internal faults of inverter, turn OFF the "DC switch", wait for 5 minutes, then turn ON the "DC switch". Check whether the fault is rectified. If no, please contact technical support.</p>
ID132	unrecoverPvUnbalance	PV unbalance current permanent fault	
ID133	Reserved	Reserved	
ID134	unrecoverAcOCPInstant	Output transient overcurrent permanent fault	

ID135	unrecoverableUnbalance	Output current imbalance permanent fault	
ID137	unrecoverablePvConfigError	Input mode configuration permanent fault	
ID138	unrecoverablePVOCPIstant	Input overcurrent permanent fault	
ID139	unrecoverableHWPVOC	Input hardware overcurrent permanent fault	There are internal faults of inverter, turn OFF the "DC switch", wait for 5 minutes, then turn ON the "DC switch". Check whether the fault is rectified. If no, please contact technical support.
ID140	unrecoverableRelayFail	Relay permanent fault	
ID141	unrecoverableBusUnbalance	Bus Unbalanced permanent fault	
ID142	LightningProtectionFaultDC	DC SPD failure	
ID143	LightningProtectionFaultAC	AC SPD failure	
ID145	USBFault	USB Failure	
ID146	WiFiFault	WIFI failure	
ID147	BluetoothFault	Bluetooth failure	There are internal faults of inverter, turn OFF the "DC switch", wait for 5 minutes, then turn ON the "DC switch". Check whether the fault is rectified. If no, please contact technical support.
ID148	RTCFault	RTCclock failure	
ID149	CommEEPROMFault	Communication BOARD EEPROM error	
ID150	CommEEPROMFault	Communication BOARD FLASH error	
ID151	Reserved	Reserved	
ID152	SafetyVersionFault	Safety Version is Fault	
ID153	SciCommLoss(DC)	SCI communication (DC side)	
ID154	SciCommLoss(AC)	SCI communication (AC side)	
ID155	SciCommLoss(Fuse)	SCI communication (DC current combined side)	

ID156	SoftVerError	Inconsistent software version	
ID157	Reserved	Reserved	
ID158	Reserved	Reserved	
ID161	ForceShutdown	ForceShutdown	Remote control enables. If it is not controlled by yourself, please disconnect the DC switch of the inverter, wait for 5 minutes, and then turn on the DC switch. Observe whether the fault has been eliminated after the inverter is restarted. If not, please contact the customer service of SOFARSOLAR.
ID162	RemoteShutdown	RemoteShutdown	
ID163	Drms0Shutdown	Drms0 shut down	
ID165	RemoteDerating	RemoteDerating	Inverter shows ID83 when remote derating. If no one operate this function, please check the connection (I/O) according to chapter 4.5
ID166	LogicInterfaceDerating	Logical interface derating	
ID167	AlarmAntiReflexing	Anti Refluxing derating	
ID169	FanFault1	Fan 1 Alarm	Check whether the inverter has dust and dust, whether there are foreign matters blocking the fan at the air inlet. If so, please improve the ventilation and heat dissipation of the environment. It is recommended that the inverter should be cleaned once every half a year.
ID170	FanFault2	Fan 2 Alarm	
ID171	FanFault3	Fan 3 Alarm	
ID172	FanFault4	Fan 4 Alarm	
ID173	FanFault5	Fan 5 Alarm	
ID174	FanFault6	Fan 6 Alarm	
ID177	Reserved	Reserved	
ID178	Reserved	Reserved	
ID179	Reserved	Reserved	
ID180	Reserved	Reserved	
ID181	Reserved	Reserved	
ID182	Reserved	Reserved	
ID193- ID224	StringFuse_Fault0-31	String fuse open circuit alarm	There are internal faults of inverter, turn OFF the "DC switch", wait for 5 minutes, then turn ON the "DC switch". Check whether the fault is rectified. If no, please contact technical support.

ID225- ID240	Reserved	Reserved	/
-----------------	----------	----------	---

Note: the above table is our general fault ID list, all fault IDs of this inverter can be found in the above table.

7.2. Maintenance

Inverters generally do not need any daily or routine maintenance. But ensure heat sink should not be blocked by dust, dirt or any other items. Before the cleaning, make sure that the DC SWITCH is turned OFF and the circuit breaker between inverter and electrical grid is turned OFF. Wait at least for 5 minutes before the Cleaning.

✧ Inverter cleaning

Please clean the inverter with an air blower, a dry & soft cloth or a soft bristle brush. Do NOT clean the inverter with water, corrosive chemicals, detergent, etc.

✧ Heat sink cleaning

For the long-term proper operation of inverters, ensure there is enough space around the heat sink for ventilation, check the heat sink for blockage (dust, snow, etc.) and clean them if they exist. Please clean the heat sink with an air blower, a dry & soft cloth or a soft bristle brush. Do NOT clean the heat sink with water, corrosive chemicals, detergent, etc.

8. Technical Data

Outlines of this Chapter

This chapter outline the SOFAR 3.3~12KTLX-G3 model type and technical parameters

Datasheet	SOFAR 3.3KTLX -G3	SOFAR 4.4KTLX -G3	SOFAR 5KTLX -G3-A	SOFAR 5.5KTLX -G3	SOFAR 6.6KTLX -G3	SOFAR 8.8KTLX -G3	SOFAR 11KTLX -G3
Input (DC)							
Recommended Max. PV input power (Wp)	4500	6000	7500	7500	9000	12000	15000
Max. DC power for single MPPT (W)	4500	6000	6000	6000	7500	7500	7500
Number of MPP trackers	2						
Number for DC inputs	1/1	1/1	1/1	1/1	1/1	1/1	1/1
Max. input voltage	1100V						
Start-up voltage	160V						
Rated input voltage	650V						
MPPT operating voltage range	140V-1000V						
Full power MPPT voltage range (V)	160-850	190V-850	240-850	240-850	290-850	380-850	420-850
Max. input MPPT current (A)	15/15	15/15	15/15	15/15	15/15	15/15	15/15
Max. input short circuit current per MPPT (A)	22.5/22.5	22.5/22.5	22.5/22.5	22.5/22.5	22.5/22.5	22.5/22.5	22.5/22.5
Output (AC)							
Rated power(W)	3000	4000	5000	5000	6000	8000	10000
Max. AC power (VA)	3300	4400	5000	5500	6600	8800	11000
Nominal output current (A.)	4.3	5.8	7.2	7.2	8.7	11.6	14.5
Max. output current (A)	5	6.7	7.6	8.3	10	13.3	16.7

Nominal grid voltage	3/N/PE,220V/380Vac,230V/400Vac						
Grid voltage range	310Vac-480Vac (According to local standard)						
Nominal frequency	50 / 60Hz						
Grid frequency range	45Hz-55Hz/54Hz-66Hz (According to local standard)						
Active power adjustable range	0~100%						
THDi	<3%						
Power factor	1 default (adjustable+/-0.8)						
Performance							
Max efficiency	98.40%	98.40%	98.40%	98.40%	98.40%	98.50%	98.50%
European weighted efficiency	97.50%	97.50%	97.50%	97.50%	97.50%	98.00%	98.00%
Self-consumption at night	<1W						
MPPT efficiency	>99.9%						
Protection							
DC reverse polarity protection	Yes						
Anti-islanding protection	Yes						
Leakage current protection	Yes						
Ground fault monitoring	Yes						
PV-array string fault monitoring	Yes						
Anti reverse power function	Yes						
DC switch	Yes						
AFCI protection	Optional						
Input/ output SPD	PV: type II standard, AC: type II standard						
Protective Class	Class I						
Overvoltage Category	AC: III, DC: II						
Communication							
Communication	RS485/USB/ Bluetooth, Optional: WiFi/GPRS						
General Data							
Ambient temperature	-30°C~+60°C						

range							
Topology	Transformerless						
Degree of protection	IP65						
Allowable relative humidity range	0~100%						
Max. operating altitude	4000m						
Noise	≤40dB	≤40dB	≤40dB	≤40dB	≤40dB	≤40dB	≤40dB
Weight	16kg	16kg	16kg	16kg	16kg	17kg	18kg
Cooling	Natural					Fan	
Dimension	430*385*182mm						
Display	LCD&Bluetooth +APP						
Standard warranty	5 years, Optional: 7 years/10 years						
Standard							
EMC	EN61000-6-1, EN61000-6-2, EN61000-6-3, EN61000-6-4						
Safety standard	IEC62109-1/2, IEC62116, IEC61727, IEC61683, IEC60068(1,2,14,30)						
Grid standard	AS/NZS 4777, VDE V 0124-100, V 0126-1-1, VDE-AR-N 4105, CEI 0-21/CEI 0-16, UNE 206 007-1, EN50549, G98/G99, EN50530, NB/T32004						

Datasheet	SOFAR 8.8KTLX -G3-A	SOFAR 10KTLX -G3-A	SOFAR 11KTLX -G3-A	SOFAR 12KTLX -G3
Input (DC)				
Recommended Max. PV input power (Wp)	12000	15000	15000	18000
Max. DC power for single MPPT (W)	7500/15000	7500/15000	7500/15000	7500/15000
Number of MPP trackers	2			
Number for DC inputs	1/2	1/2	1/2	1/2
Max. input voltage	1100V			
Start-up voltage	160V			
Rated input voltage	650V			
MPPT operating voltage range	140V-1000V			
Full power MPPT voltage range (V)	380-850	420-850	420-850	460-850
Max. input MPPT current (A)	15/30	15/30	15/30	15/30
Max. input short circuit current per MPPT (A)	22.5/45	22.5/45	22.5/45	22.5/45
Output(AC)				
Rated power (W)	8000	10000	10000	12000
Max. AC power (VA)	8800	10000	11000	13200
Nominal output current (A)	11.6	14.5	14.5	17.4
Max. output current(A)	13.3	15.2	16.7	20
Nominal grid voltage	3/N/PE,220V/380Vac,230V/400Vac			
Grid voltage range	310Vac-480Vac (According to local standard)			
Nominal frequency	50 / 60Hz			
Grid frequency range	45Hz-55Hz/54Hz-66Hz (According to local standard)			
Active power adjustable range	0~100%			

THDi	<3%			
Power factor	1 default (adjustable+/-0.8)			
Performance				
Max efficiency	98.50%	98.50%	98.50%	98.50%
European weighted efficiency	98.00%	98.00%	98.00%	98.00%
Self-consumption at night	<1W			
MPPT efficiency	>99.9%			
Protection				
DC reverse polarity protection	Yes			
Anti-islanding protection	Yes			
Leakage current protection	Yes			
Ground fault monitoring	Yes			
PV-array string fault monitoring	Yes			
Anti reverse power function	Yes			
DC switch	Yes			
AFCI protection	Optional			
Input/ output SPD	PV: type II standard, AC: type II standard			
Protective Class	Class I			
Overvoltage Category	AC: III, DC: II			
Communication				
Communication	RS485/USB/ Bluetooth, Optional:WiFi /GPRS			
General Data				
Ambient temperature range	-30°C~+60°C			
Topology	Transformerless			
Degree of protection	IP65			
Allowable relative humidity range	0~100%			

Max. operating altitude	4000m			
Noise	≤40dB	≤40dB	≤40dB	≤40dB
Weight	17kg	17kg	17kg	17kg
Cooling	Fan			
Dimension	430*385*182mm			
Display	LCD&Bluetooth +APP			
Standard warranty	5 years, Optional: 7 years/ 10 years			
Standard				
EMC	EN61000-6-1, EN61000-6-2, EN61000-6-3, EN61000-6-4			
Safety standard	IEC62109-1/2, IEC62116, IEC61727, IEC61683, IEC60068(1,2,14,30)			
Grid standard	AS/NZS 4777, VDE V 0124-100, V 0126-1-1, VDE-AR-N 4105, CEI 0-21/CEI 0-16, UNE 206 007-1, EN50549, G98/G99, EN50530, NB/T32004			

Note: the product may be upgraded in the future. The above parameters are for reference only. Please refer to the real product.

9. Quality Assurance

Standard warranty period

The standard warranty period of inverter is 60 months (5 years). There are two calculation methods for the warranty period:

1. Purchase invoice provided by the customer: the first flight provides a standard warranty period of 60 months (5 years) from the invoice date;
2. The customer fails to provide the invoice: from the production date (according to the SN number of the machine), Our company provides a warranty period of 63 months (5.25 years).
3. In case of any special warranty agreement, the purchase agreement shall prevail.

Extended warranty period

Within 12 months of the purchase of the inverter (based on the purchase invoice) or within 24 months of the production of the inverter (SN number of machines, based on the first date of arrival), Customers can apply to buy extended warranty products from the company's sales team by providing the product serial number, our company may refuse to do not conform to the time limit extended warranty purchase application. Customers can buy an extended warranty of 5, 10, 15 years.

If the customer wants to apply for the extended warranty service, please contact the sales team of our company. to purchase the products that are beyond the purchase period of extended warranty but have not yet passed the standard quality warranty period. Customers shall bear different extended premium.

During the extended warranty period, PV components, USB acquisition stick (WIFI/Ethernet) and lightning protection devices are not included in the extended warranty period. If they fail during the extended warranty period,

customers need to purchase and replace them from our company.

Once the extended warranty service is purchased, our company will issue the extended warranty card to the customer to confirm the extended warranty period.

Invalid warranty clause

Equipment failure caused by the following reasons is not covered by the warranty:

- 1) The "warranty card" has not been sent to the distributor or our company;
- 2) Without the consent of our company to change equipment or replace parts;
- 3) Use unqualified materials to support our company 's products, resulting in product failure;
- 4) Technicians of non-company modify or attempt to repair and erase the product serial number or silk screen;
- 5) Incorrect installation, debugging and use methods;
- 6) Failure to comply with safety regulations (certification standards, etc.);
- 7) Damage caused by improper storage by dealers or end users;
- 8) Transportation damage (including scratches caused by internal packaging during transportation). Please claim directly from the transportation company or insurance company as soon as possible and obtain damage identification such as container/package unloading;
- 9) Failure to follow the product user manual, installation manual and maintenance guidelines;
- 10) Improper use or misuse of the device;
- 11) Poor ventilation of the device;
- 12) The product maintenance process does not follow relevant standards;
- 13) Failure or damage caused by natural disasters or other force (such as earthquake, lightning strike, fire, etc.)



Product Name: PV Grid-Connected Inverter
Company Name: Shenzhen SOFARSOLAR Co., Ltd.
ADD: 11/F, Gaoxinqi science and technology building, district 67, XingDong
Community, XinAn Street, BaoAn District, Shenzhen, China.
Email: service@sofarsolar.com
Tel: 0510-6690 2300
Web: www.sofarsolar.com

