

# User Manual

## Hybrid 10KW/12KW/15KW PV Inverter

Version: 1.4

# Table Of Contents

1.	Introduction	1
2.	Important Safety Warning	2
3.	Unpacking & Overview	4
3-1.	Packing List	4
3-2.	Product Overview	4
4.	Installation	5
4-1.	Precaution	5
4-2.	Selecting Mounting Location	5
4-3.	Mounting Unit	5
5.	Grid (Utility) Connection	6
5-1.	Preparation	6
5-2.	Connecting to the AC Utility	7
6.	PV Module (DC) Connection	9
7.	Battery Connection	13
8.	Load (AC Output) Connection	14
8-1.	Preparation	14
8-2.	Connecting to the AC output	14
9.	Communication Connection	16
10.	Dry Contact Signal	17
10-1.	Electric Parameter	17
10-2.	Function Description	18
11.	Application with Energy Meter	19
12.	Commissioning	20
13.	Initial Setup	21
14.	Operation	33
14-1.	Interface	33
14-2.	LCD Information Define	33
14-3.	Touchable function keys	35
14-4.	LCD Setting	36
14-5.	LCD Display Information	44
14-6.	Operation Mode & Display	49
15.	Charging Management	53
16.	Maintenance & Cleaning	55
17.	Trouble Shooting	56
17-1.	Warning List	56
17-2.	Fault Reference Codes	57
18.	Specifications	60
Appendix I: Parallel Installation Guide		62
Introduction		62
Parallel cable		62
Overview		62

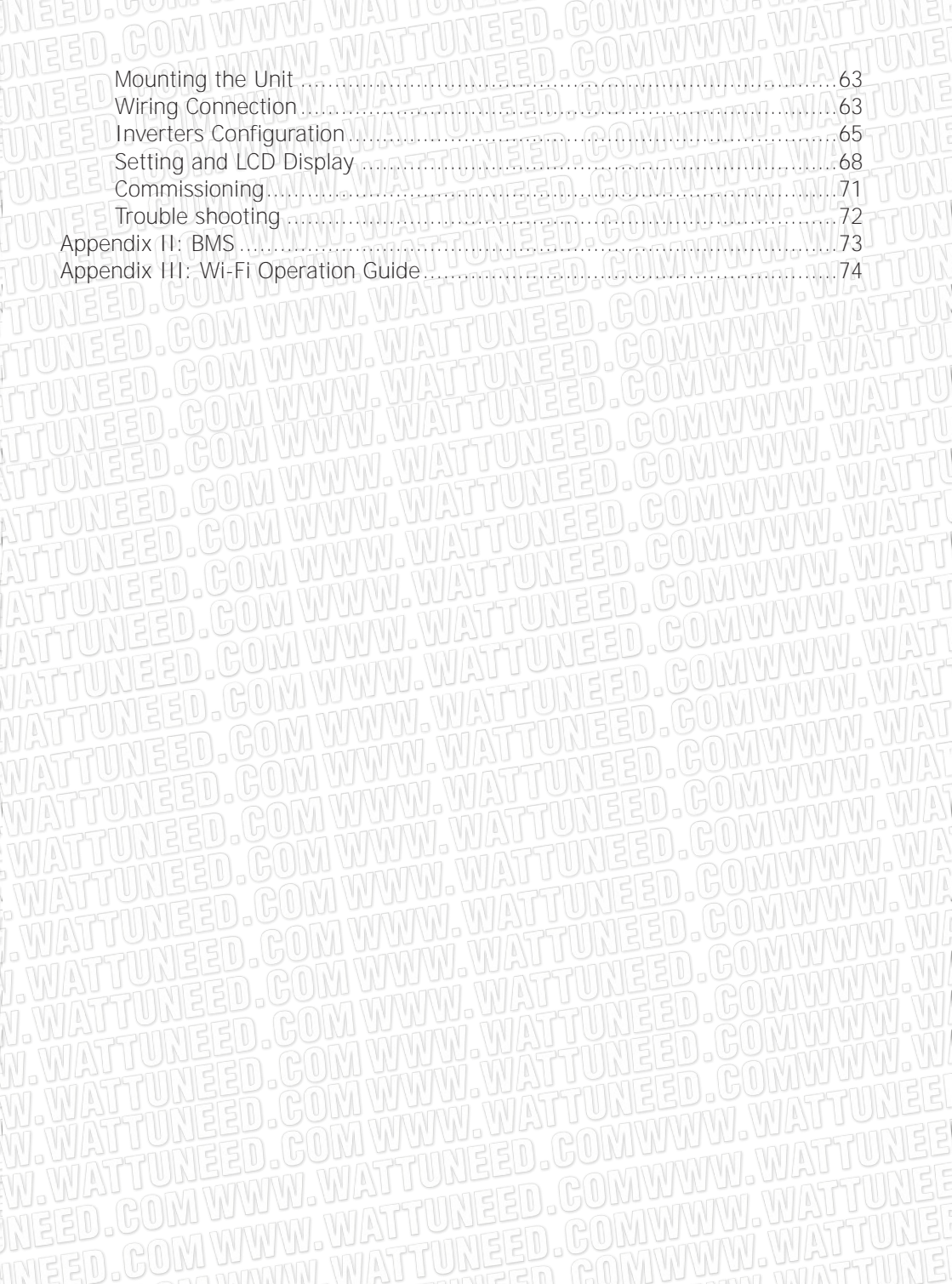

Mounting the Unit .....	63
Wiring Connection .....	63
Inverters Configuration .....	65
Setting and LCD Display .....	68
Commissioning .....	71
Trouble shooting .....	72
Appendix II: BMS .....	73
Appendix III: Wi-Fi Operation Guide .....	74

# 1. Introduction

This hybrid PV inverter can provide power to connected loads by utilizing PV power, utility power and battery power

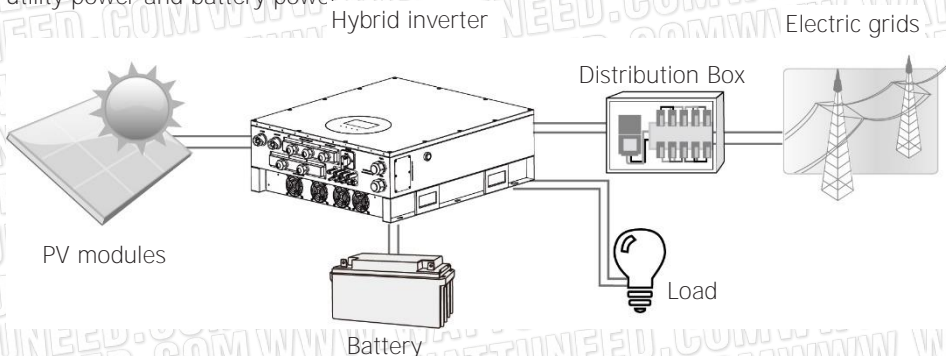

Figure 1 Basic hybrid PV System Overview

Depending on different power situations, this hybrid inverter is designed to generate continuous power from PV solar modules (solar panels), battery, and the utility. When MPP input voltage of PV modules is within acceptable range (see specification for the details), this inverter is able to generate power to feed the grid (utility) and charge battery. This inverter is only compatible with PV module types of single crystalline and poly crystalline. Do not connect any PV array types other than these two types of PV modules to the inverter. Do not connect the positive or negative terminal of the solar panel to the ground. See Figure 1 for a simple diagram of a typical solar system with this hybrid inverter.

Note: By following the EEG standard, every inverter sold to German area is not allowed to charge battery from Utility. The relevant function is automatically disabled by the software.

## 2. Important Safety Warning

Before using the inverter, please read all instructions and cautionary markings on the unit and this manual. Store the manual where it can be accessed easily.

This manual is for qualified personnel. The tasks described in this manual may be performed by qualified personnel only.

General Precaution-

Conventions used:

**WARNING!** Warnings identify conditions or practices that could result in personal injury;

**CAUTION!** Caution identify conditions or practices that could result in damaged to the unit or other equipment connected.



**WARNING!** Before installing and using this inverter, read all instructions and cautionary markings on the inverter and all appropriate sections of this guide.



**WARNING!** Normally grounded conductors may be ungrounded and energized when a ground fault is indicated.



**WARNING!** This inverter is heavy. It should be lifted by at least two persons.



**CAUTION!** Authorized service personnel should reduce the risk of electrical shock by disconnecting AC, DC and battery power from the inverter before attempting any maintenance or cleaning or working on any circuits connected to the inverter. Turning off controls will not reduce this risk. Internal capacitors can remain charged for 5 minutes after disconnecting all sources of power.



**CAUTION!** Do not disassemble this inverter yourself. It contains no user-serviceable parts. Attempt to service this inverter yourself may cause a risk of electrical shock or fire and will void the warranty from the manufacturer.



**CAUTION!** To avoid a risk of fire and electric shock, make sure that existing wiring is in good condition and that the wire is not undersized. Do not operate the Inverter with damaged or substandard wiring.



CAUTION! Under high temperature environment, the cover of this inverter could be hot enough to cause skin burns if accidentally touched. Ensure that this inverter is away from normal traffic areas.



CAUTION! Use only recommended accessories from installer. Otherwise, not-qualified tools may cause a risk of fire, electric shock, or injury to persons.



CAUTION! To reduce risk of fire hazard, do not cover or obstruct the cooling fan.



CAUTION! Do not operate the Inverter if it has received a sharp blow, been dropped, or otherwise damaged in any way. If the Inverter is damaged, please call for an RMA (Return Material Authorization).



CAUTION! AC breaker, DC switch and Battery circuit breaker are used as disconnect devices and these disconnect devices shall be easily accessible.

- Before working on this circuit
- Isolate inverter/Uninterruptible Power System (UPS)
  - Then check for Hazardous Voltage between all terminals including the protective earth.



Risk of Voltage Backfeed

### Symbols used in Equipment Markings

	Refer to the operating instructions
	Caution! Risk of danger
	Caution! Risk of electric shock
	Caution! Risk of electric shock. Energy storage timed discharge for 5 minutes.
	Caution! Hot surface

### 3. Unpacking & Overview

#### 3-1. Packing List

Before installation, please inspect the unit. Be sure that nothing inside the package is damaged. You should have received the following items inside of package:

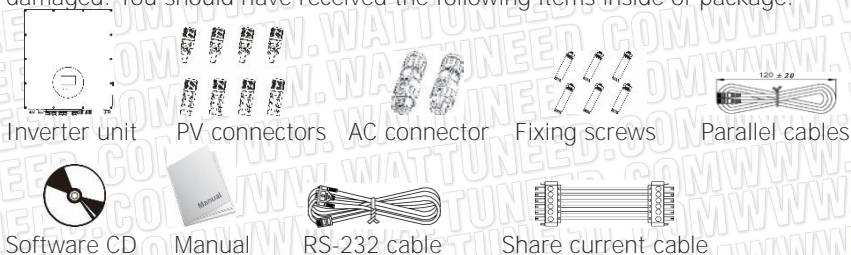

#### 3-2. Product Overview

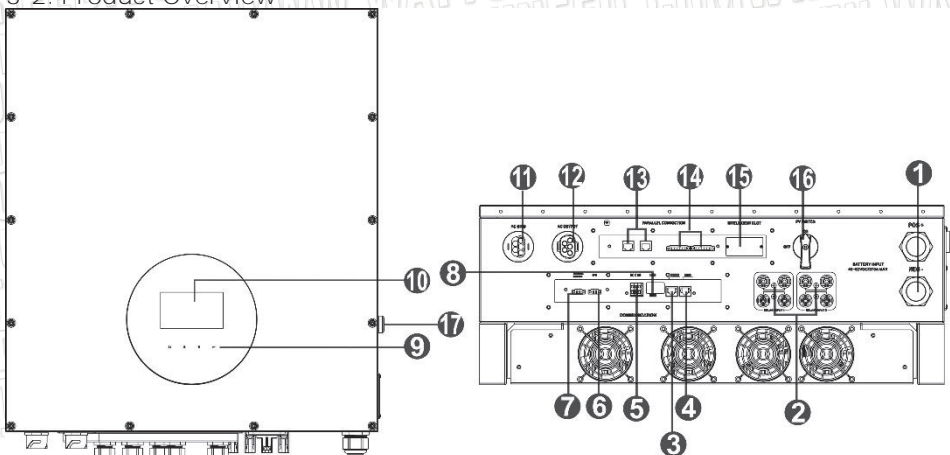

- |                              |  |
|------------------------------|--|
| 1) Battery connectors        | 10) LCD display panel (Please check section 14 for detailed LCD operation) |
| 2) PV connectors             | 11) AC Grid connectors   |
| 3) RS-232 communication port | 12) AC output connectors (Load connection)                                 |
| 4) BMS                       | 13) Parallel communication port  |
| 5) Dry contact               | 14) Current sharing port   |
| 6) EPO                       | 15) Intelligent slot   |
| 7) Battery thermal sensor    | 16) DC switch  |
| 8) USB communication port    | 17) Cold start button  |
| 9) Touchable buttons         |  |

## 4. Installation

### 4-1. Precaution

This Hybrid inverter is designed for indoor or outdoor use (IP65), please make sure the installation site meets below conditions:

- Not in direct sunlight
- Not in areas where highly flammable materials are stored.
- Not in potential explosive areas.
- Not in the cool air directly.
- Not near the television Antenna or antenna cable.
- Not higher than altitude of about 2000 meters above sea level.
- Not in environment of precipitation or humidity (>95%)

Please AVOID direct sunlight, rain exposure, snow laying up during installation and operation.

### 4-2. Selecting Mounting Location

- Please select a vertical wall with load-bearing capacity for installation, appropriate for installation on concrete or other non-flammable surfaces.
- The ambient temperature should be between  $-25\sim 60^{\circ}\text{C}$  to ensure optimal operation.
- Be sure to keep other objects and surfaces as shown in the diagram to guarantee sufficient heat dissipation and have enough space for removing wires.
- For proper air ventilation to dissipate heat, allow a clearance of approx. 50cm to the side and approx. 50cm above and below the unit. And 100cm toward the front.

### 4-3. Mounting Unit

**WARNING!!** Remember that this inverter is heavy! Please be carefully when lifting out from the package.

Installation to the wall should be implemented with the proper screws. After that, the device should be bolted on securely.

**WARNING!! FIRE HAZARD.**  
SUITABLE FOR MOUNTING ON CONCRETE OR OTHER NON-COMBUSTIBLE SURFACE ONLY.



1. Drill six holes in the marked locations with supplied six screws. The reference tightening torque is 35 N.m.
2. Fix the inverter on the wall.

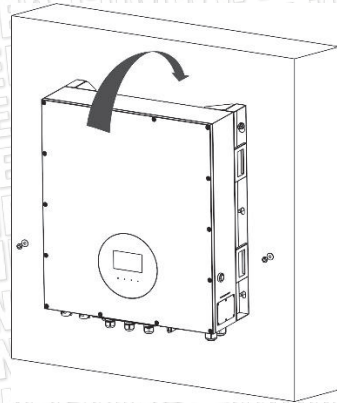
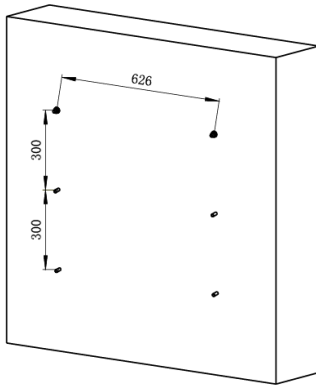

3. Check if the inverter is firmly secured.

## 5. Grid (Utility) Connection

### 5-1. Preparation

NOTE: The overvoltage category of the AC input is III. It should be connected to the power distribution.

NOTE2: Before connecting to grid, please install a separate AC breaker between inverter and grid. The recommended of AC breaker is 40A.

**WARNING!** It's very important for system safety and efficient operation to use appropriate cable for grid (utility) connection. To reduce risk of injury, please use the proper recommended cable size as below.

Suggested cable requirement for AC wire:

Nominal Grid Voltage	230VAC per phase
Conductor cross-section (mm <sup>2</sup> )	10-16
AWG no.	8-6

## 5-2. Connecting to the AC Utility

### Overview of AC Connection Socket



Component	Description
A	Pressure dome
B	Plastic ring
C	Protective element
D	Socket element

Step 1: Check the grid voltage and frequency with an AC voltmeter. It should be the same to "VAC" value on the product label.

Step 2: Turn off the circuit breaker.

Step 3: Remove insulation sleeve 13 mm for five conductors.

Step 4: Thread the five cables through pressure dome (A), plastic ring (B) and protective element (C) in sequence.

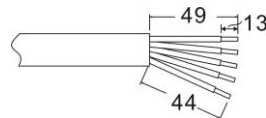

Step 5: Thread five cables through socket element (D) according to polarities indicated on it and tighten the screws to fix wires after connection.

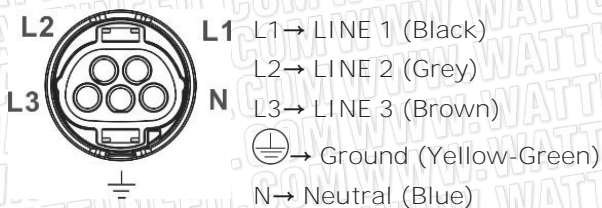

The reference tightening torque is 1.5-2.5 N.m.

Step 6: Push protective element (C) on to socket element (D) until both are locked tightly. Then, twist protective element (C) and pressure dome (A) so that all cables are firmly connected.

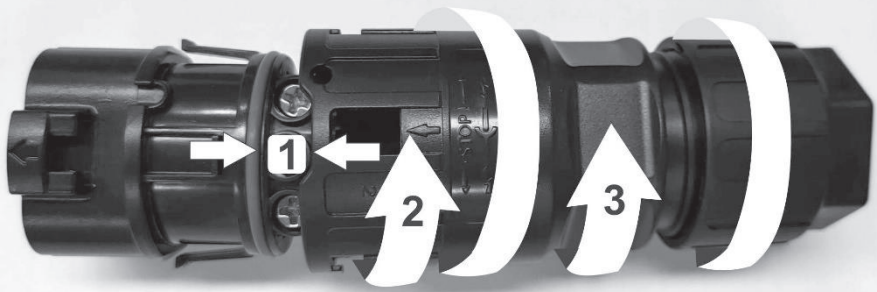

Step 7: Plug the AC connection socket into AC grid terminal of the inverter.

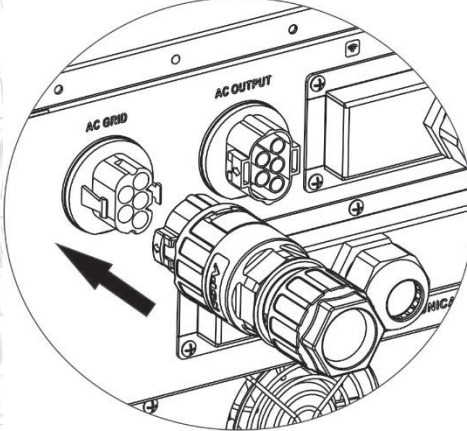

**CAUTION:** To prevent risk of electric shock, ensure the ground wire is properly earthed before operating this hybrid inverter no matter the grid is connected or not.

## 6. PV Module (DC) Connection

NOTE1: Please use 1000VDC/20A circuit breaker.

NOTE2: The overvoltage category of the PV input is II.

Please follow below steps to implement PV module connection:

**WARNING:** Because this inverter is non-isolated, only two types of PV modules are acceptable: single crystalline and poly crystalline with class A-rated.

To avoid any malfunction, do not connect any PV modules with possibility of leakage current to the inverter. For example, grounded PV modules will cause leakage current to the inverter.

**CAUTION:** It's requested to have PV junction box with surge protection. Otherwise, it will cause inverter damage when lightning occurs on PV modules.

Step 1: Check the input voltage of PV array modules. The acceptable input voltage of the inverter is 350VDC - 1000VDC. This system is only applied with two strings of PV array. Please make sure that the maximum current load of each PV input connector is 23A.

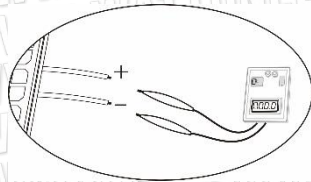

**CAUTION:** Exceeding the maximum input voltage can destroy the unit!! Check the system before wire connection.

Step 2: Disconnect the circuit breaker and switch off the DC switch.

Step 3: Assemble provided PV connectors with PV modules by the following below steps.

Components for PV connectors and Tools:

Female connector housing	
Female terminal	
Male connector housing	
Male terminal	

## Crimping tool and spanner



### Cable preparation and connector assembly process:

Strip one cable 8 mm on both end sides and be careful NOT to nick conductors.

Cabel  
 $L > 30\text{mm}$



Insert striped cable into female terminal and crimp female terminal as shown below charts.



Insert assembled cable into female connector housing as shown below charts.

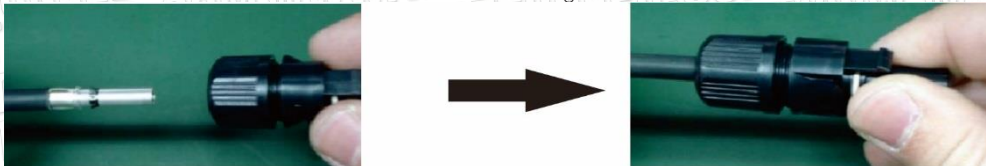

Insert striped cable into male terminal and crimp male terminal as shown below charts.



Insert assembled cable into male connector housing as shown below charts.

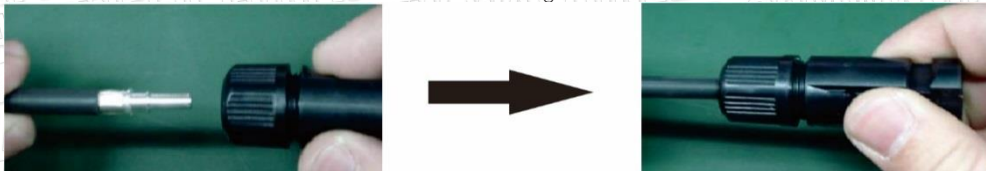

Then, use spanner to screw pressure dome tightly to female connector and male connector as shown below.



Step 4: Check correct polarity of connection cable from PV modules and PV input connectors. Then, connect positive pole (+) of connection cable to positive pole (+) of PV input connector. Connect negative pole (-) of connection cable to negative pole (-) of PV input connector.

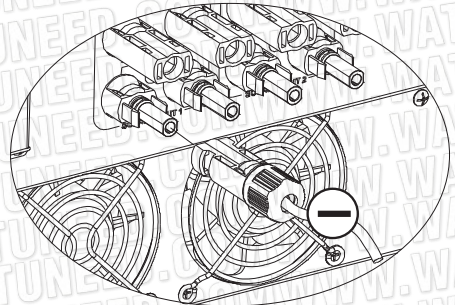
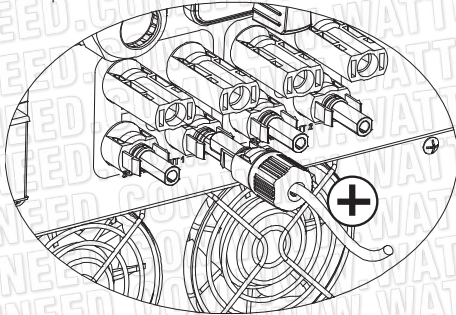

**WARNING!** It's very important for system safety and efficient operation to use appropriate cable for PV module connection. To reduce risk of injury, please use the proper recommended cable size as below.

Conductor cross-section (mm <sup>2</sup> )	AWG no.
6	10

**CAUTION:** Never directly touch terminals of the inverter. It will cause lethal electric

**CAUTION:** Do NOT touch the inverter to avoid electric shock. When PV modules are exposed to sunlight, it may generate DC voltage to the inverter.

## Recommended Panel Configuration

	Solar panel			
Nominal Max. Power (Pmax) (W)	430	455	520	535
Opt. Operating Voltage (Vmp) (V)	40.3	41.3	41.6	41.9
Opt. Operating Current (Imp) (A)	10.68	11.02	12.5	12.77
Open Circuit Voltage (Voc) (V)	48.3	49.3	49.14	49.44
Short Circuit Current (Isc) (A)	11.37	11.66	13.23	13.5
For 16KW input recommendation				
Numbers in series of MPPT1	19	18	16	15
Numbers of strings in MPPT1	1	1	1	1
Maximum input voltage of MPPT1 (V)	917.7	887.4	786.24	741.6
Input power of MPPT1 (W)	8170	8190	8320	8025
Numbers in series of MPPT2	19	18	16	15
Numbers of strings in MPPT2	1	1	1	1
Maximum input voltage of MPPT1 (V)	917.7	887.4	786.24	741.6
Input power of MPPT2 (W)	8170	8190	8320	8025
Total input power (W)	16340	16380	16640	16050
Minimum input recommendation				
Numbers in series of MPPT1	10	10	10	10
Numbers of strings in MPPT1	1	1	1	1
Maximum input voltage of MPPT1 (V)	483	493	491.4	494.4
Input power of MPPT1 (W)	4300	4550	5200	5350
Numbers in series of MPPT2	10	10	10	10
Numbers of strings in MPPT2	1	1	1	1
Maximum input voltage of MPPT1 (V)	483	493	491.4	494.4
Input power of MPPT2 (W)	4300	4550	5200	5350

## 7. Battery Connection

**CAUTION:** Before connecting to batteries, please install separately a DC circuit breaker between inverter and batteries.

**NOTE1:** Please only use sealed lead acid battery, vented and Gel battery. Please check maximum charging voltage and current when first using this inverter. If using Lithium iron or Nicd battery, please consult with installer for the details.

**NOTE2:** Please use 60VDC/300A circuit breaker.

**NOTE3:** The overvoltage category of the battery input is II.

Please follow below steps to implement battery connection:

**Step 1:** Check the nominal voltage of batteries. The nominal input voltage for inverter is 48VDC.

**Step 2:** Use two battery cables. Remove insulation sleeve 12 mm and insert conductor into cable ring terminal. Refer to right chart.

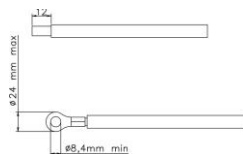

**Step 3:** Remove battery cover and follow battery polarity guide printed near the battery terminal! Place the external battery cable ring terminal over the battery terminal.

RED cable to the positive terminal (+);

BLACK cable to the negative terminal (-).

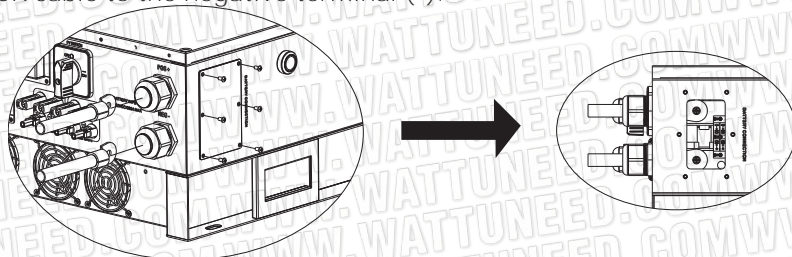

**WARNING!** Wrong connections will damage the unit permanently.

**Step 4:** Make sure the wires are securely connected. The reference tightening torque is 5.5~7.0 N.m.

**WARNING!** It's very important for system safety and efficient operation to use appropriate cable for battery connection. To reduce risk of injury, please use the proper recommended cable size as below.

Model	Nominal Battery Voltage	Conductor cross-section (mm <sup>2</sup> )	AWG no.	Protective earthing (battery side)
10 KW/ 12 KW	48V	107	4/0	150mm <sup>2</sup> (300kcmil)
15 KW	48V	151	300	150mm <sup>2</sup> (300kcmil)



## 8. Load (AC Output) Connection

### 8-1. Preparation

**CAUTION:** To prevent further supply to the load via the inverter during any mode of operation, an additional disconnection device should be placed on in the building wiring installation.

**WARNING!** It's very important for system safety and efficient operation to use appropriate cable for AC connection. To reduce risk of injury, please use the proper recommended cable size as below.

Nominal Grid Voltage	208/220/230/240 VAC per phase
Conductor cross-section (mm <sup>2</sup> )	5.5-10
AWG no.	10-8

### 8-2. Connecting to the AC output

#### Overview of Load Connection Socket



Component	Description
A	Pressure dome
B	Plastic ring
C	Protective element
D	Socket element

Step 1: Remove insulation sleeve 8.5 mm for five conductors.

Step 2: Thread the five cables through pressure dome (A), plastic ring (B) and protective element (C) in sequence.

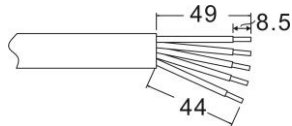

Step 3: Thread five cables through socket element (D) according to polarities indicated on it and tighten the screws to fix wires after connection.

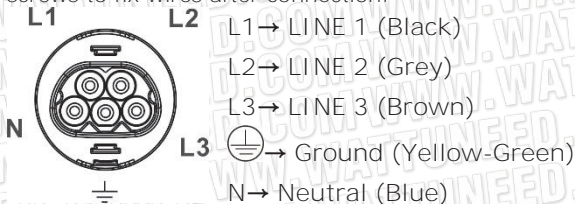

The reference tightening torque is 1.0-1.5 N.m.

Step 4: Push protective element (C) on to socket element (D) until both are locked tightly. Then, twist protective element (C) and pressure dome (A) so that all cables are firmly connected.

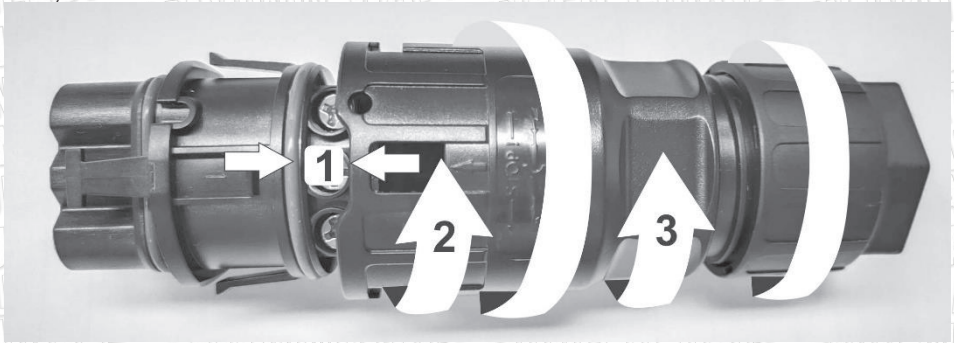

Step 5: Plug the socket into the terminal.

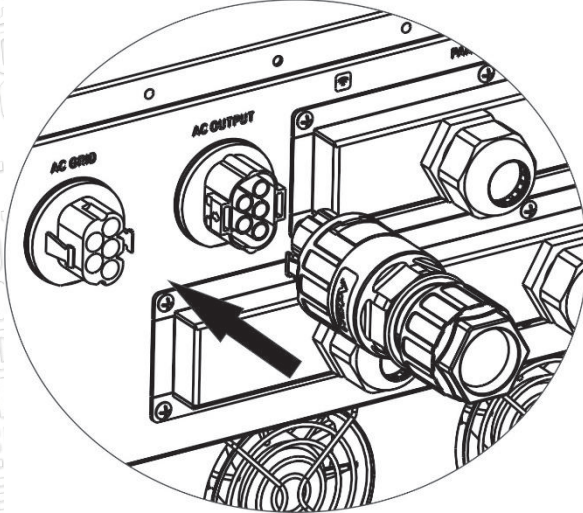

**CAUTION:** It's only allowed to connect load to "AC Output Connector". Do NOT connect the utility to "AC Output Connector".

**CAUTION:** Be sure to connect L terminal of load to L terminal of "AC Output Connector" and N terminal of load to N terminal of "AC Output Connector". The G terminal of "AC Output Connector" is connected to grounding of the load. Do NOT mis-connect.

## 9. Communication Connection

### Serial Connection

The inverter is equipped with several communication ports and it is also equipped with a slot for alternative communication interfaces in order to communicate with a PC with corresponding software. This intelligent slot is suitable to install with SNMP card and Modbus card. Follow below procedure to connect communication wiring and install the software.

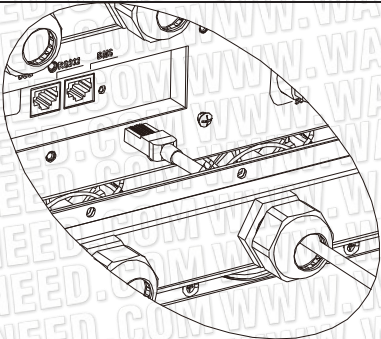
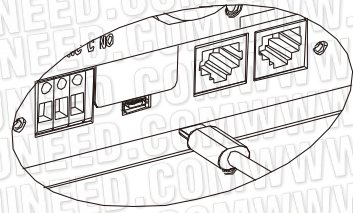
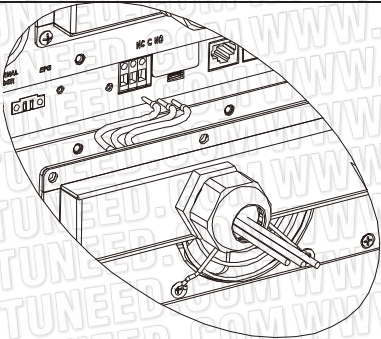
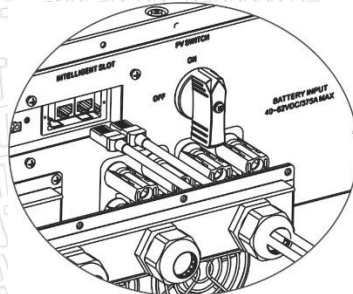
<p>For RS232 or BMS port, use a RJ45 cable as follows:</p>	<p>For USB port, use a USB cable as follows:</p>
	
<p>For Dry contact port, please remove insulation sleeve 8 mm for three conductors and insert three cables into ports</p>	<p>For SNMP or MODBUS port, use the RJ45 cables as follows:</p>
	

Please install monitoring software in your computer. Detailed information is listed in the chapter 12. After software is installed, you may initial the monitoring software and extract data through communication port.

### Wi-Fi Connection

Wi-Fi module can enable wireless communication between off-grid inverters and monitoring platform. Users have complete and remote monitoring and controlling experience for inverters when combining Wi-Fi module with SolarPower APP, available for both iOS and Android based device. All data loggers and parameters are saved in iCloud.

For quick installation and operation, please refer to Appendix III - The Wi-Fi Operation Guide for details.

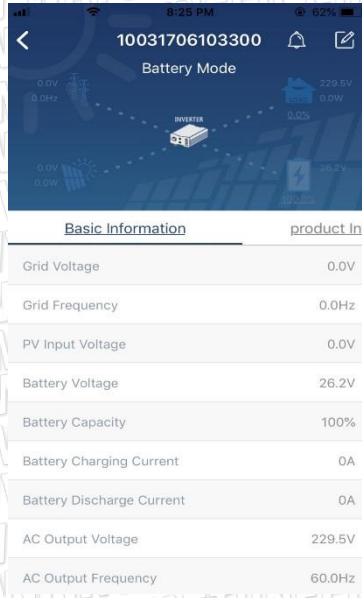

## 10. Dry Contact Signal

There is one dry contact available on the bottom panel. It could be used to remote control for external generator.

### 10-1. Electric Parameter

Parameter	Symbol	Max.	Unit
Relay DC voltage	Vdc	30	V
Relay DC current	Idc	1	A

Note: The application of the dry contact should not exceed the electric parameter shown as above. Otherwise, the internal relay will be damaged.

## 10-2. Function Description

Unit Status	Condition	Dry contact port: 	
		NO&C	NC&C
Power Off	Unit is off and no output is powered.	Open	Close
Power On	Battery voltage is lower than setting battery cut-off discharging voltage when grid is available.	Close	Open
	Battery voltage is lower than setting battery cut-off discharging voltage when grid is unavailable.	Close	Open
	Battery voltage is higher than below 2 setting values: 1. Battery re-discharging voltage when grid is available. 2. Battery re-discharging voltage when grid unavailable.	Open	Close

You can set the related parameters in software. Refer to below chart:

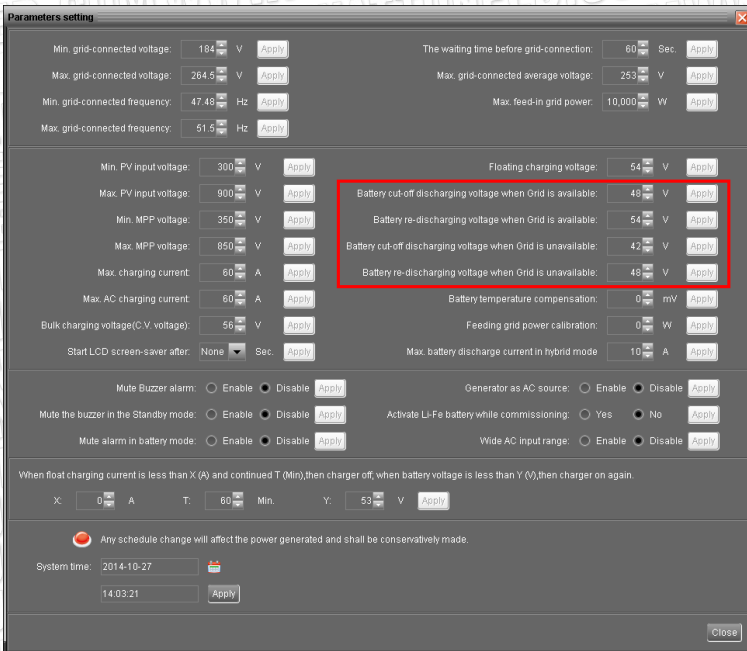

**Parameters setting**

Min. grid-connected voltage: 104 V       The waiting time before grid-connection: 60 Sec.

Max. grid-connected voltage: 264.5 V       Max. grid-connected average voltage: 253 V

Min. grid-connected frequency: 47.48 Hz       Max. feed-in grid power: 10,000 W

Max. grid-connected frequency: 51.5 Hz

Min. PV input voltage: 300 V       Floating charging voltage: 54 V

Max. PV input voltage: 900 V

Min. MPP voltage: 350 V       **Battery cut-off discharging voltage when Grid is available: 40 V**

Max. MPP voltage: 850 V       **Battery re-discharging voltage when Grid is available: 54 V**

Max. charging current: 60 A       **Battery cut-off discharging voltage when Grid is unavailable: 42 V**

Max. AC charging current: 80 A       **Battery re-discharging voltage when Grid is unavailable: 40 V**

Bulk charging voltage(C-V. voltage): 56 V       Battery temperature compensation: 0 mV

Start LCD screen-saver after: None Sec.       Feeding grid power calibration: 0 W

Max. battery discharge current in hybrid mode: 10 A

Mute Bluzzer alarm:  Enable  Disable       Generator as AC source:  Enable  Disable

Mute the buzzer in the Standby mode:  Enable  Disable       Activate Li-Fe battery while commissioning:  Yes  No

Mute alarm in battery mode:  Enable  Disable       Wide AC input range:  Enable  Disable

When float charging current is less than X (A) and continued T (Min),then charger off, when battery voltage is less than Y (V),then charger on again.

X: 0 A      T: 60 Min.      Y: 53 V

 Any schedule change will affect the power generated and shall be conservatively made.

System time: 2014-10-27

14:03:21

## 11. Application with Energy Meter

With Modbus card II and energy meter, hybrid inverter can be easily integrated into the existing household system. For details please refer to Modbus card II manual.

Note: this application is only valid for Grid-Tie with Backup II mode.

Equipped with Modbus card II, hybrid inverter is connected to energy meter with RS485 communication port. It's to arrange self-consumption via Modbus card to control power generation and battery charging of the inverter.

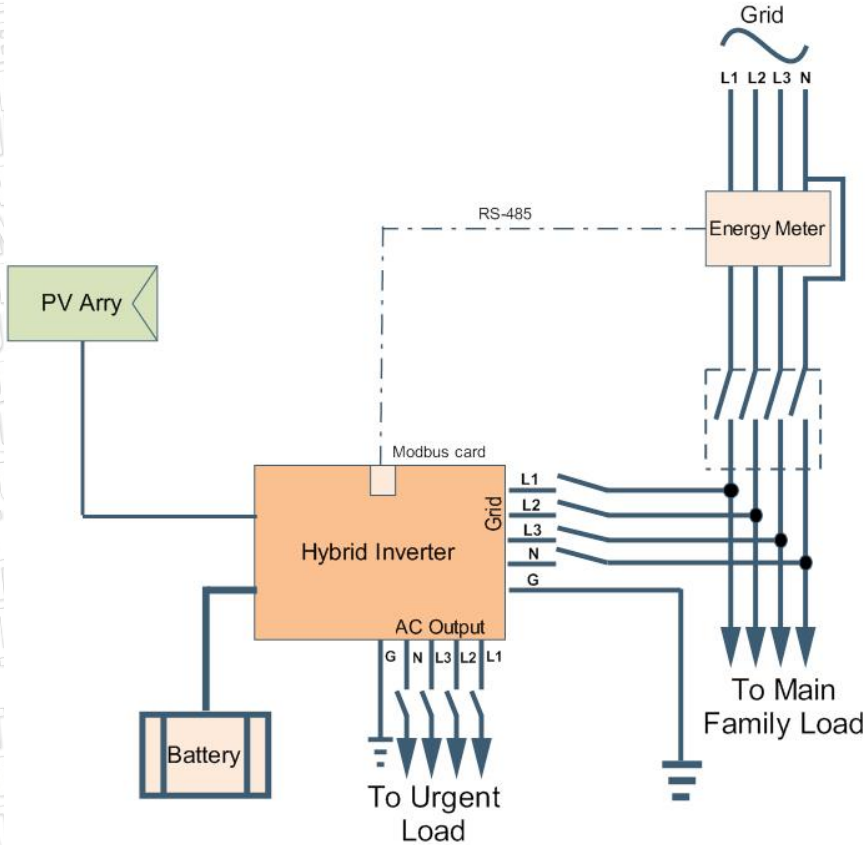



## 12. Commissioning

Step 1: Check the following requirements before commissioning:

- Ensure the inverter is firmly secured
- Check if the open circuit DC voltage of PV module meets requirement (Refer to Section 6)
- Check if the open circuit utility voltage of the utility is at approximately same to the nominal expected value from local utility company.
- Check if connection of AC cable to grid (utility) is correct if the utility is required.
- Full connection to PV modules.
- AC circuit breaker (only applied when the utility is required), batter circuit breaker, and DC circuit breaker are installed correctly.

Step 2: Switch on the battery circuit breaker and then switch on PV DC breaker. After that, if there is utility connection, please switch on the AC circuit breaker. At this moment, the inverter is turned on already. However, there is no output generation for loads. Then:

- If LCD lights up to display the current inverter status, commissioning has been successfully. After pressing "" button for 1 second when the utility is detected, this inverter will start to supply power to the loads. If no utility exists, simply press "" button for 3 seconds. Then, this inverter will start to supply power to the loads.
- If a warning/fault indicator appears in LCD, an error has occurred to this inverter. Please inform your installer.

NOTE: If only battery is available and LCD is off, press "Cold start button" to light up the LCD display.

Step 3: Please insert CD into your computer and install monitoring software in your PC.

Follow below steps to install software.

1. Follow the on-screen instructions to install the software.
2. When your computer restarts, the monitoring software will appear as shortcut icon located in the system tray, near the clock.

NOTE: If using modbus card as communication interface, please install bundled software. Check local dealer for the details.

### 13. Initial Setup

Before inverter operation, it's required to set up "Operation Mode" via software. Please strictly follow below steps to set up. For more details, please check software manual.

Step 1: After turning on the inverter and installing the software, please click "Open Monitor" to enter main screen of this software.

Step 2: Log in into software first by entering default password "administrator".

Step 3: Select Device Control >> MyPower Management. It is to set up inverter operation mode and personalized interface. Refer to diagram below.

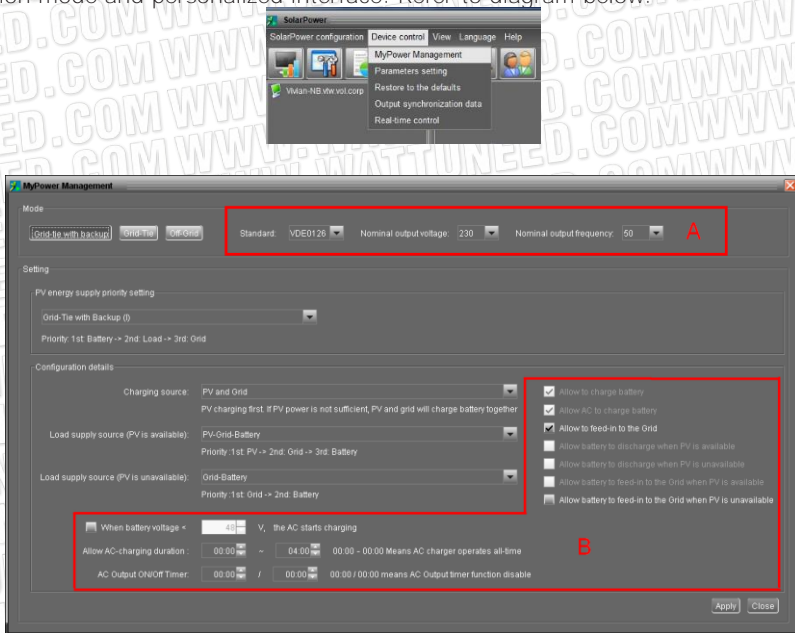

#### Mode

There are three operation modes: Grid-tie with backup, Grid-Tie and Off-Grid.

- Grid-tie with backup: PV power can feed-in back to grid, provide power to the load and charge battery. There are four options available in this mode: Grid-tie with backup I, II, III and IV. In this mode, users can configure PV power supply priority, charging source priority and load supply source priority. However, when Grid-tie with backup IV option is selected in PV energy supply priority, the inverter is only operated between two working logics based on defined peak time and off-peak time of electricity. Only peak time and off-peak time of electricity are able to set up for optimized electricity usage.
- Grid-Tie: PV power only can feed-in back to grid.
- Off-Grid: PV power only provides power to the load and charge battery. No feed-in back to grid is allowed.



## SECTION A:

Standard: It will list local grid standard. It's requested to have factory password to make any modifications. Please check local dealer only when this standard change is requested.

**CAUTION:** Wrong setting could cause the unit damage or not working.

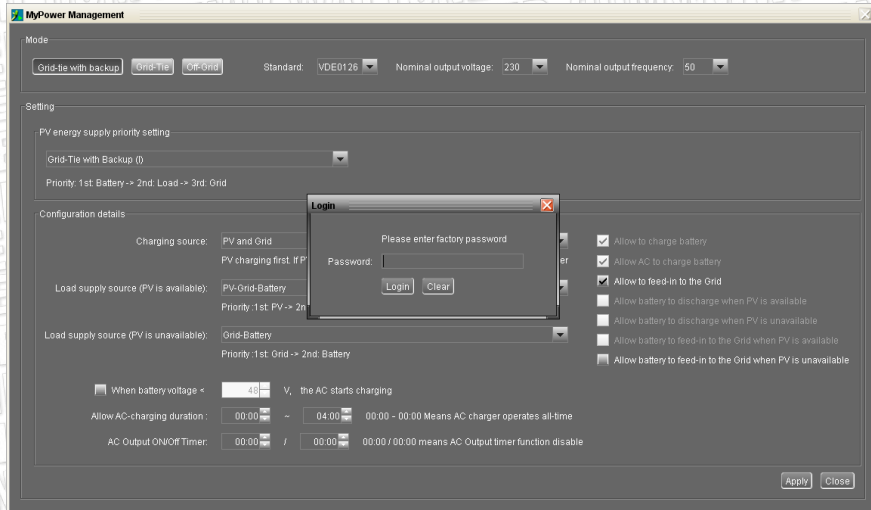

Nominal Output Voltage: 230V.

Nominal Output Frequency: 50HZ.

## SECTION B:

This section contents may be different based on different selected types of operations.

**Allow AC charging duration:** It's a period time to allow AC (grid) to charge battery. When the duration is set up as 0:00-00:00, it means no time limitation for AC to charge battery.

**AC output ON/Off Timer:** Set up on/off time for AC output of inverter. If setting it as 00:00/00:00, this function is disabled.

**Allow to charge battery:** This option is automatically determined by setting in "Charging source". It's not allowed to modify here. When "NONE" is selected in charging source section, this option becomes unchecked as grey text.

**Allow AC to charge battery:** This option is automatically determined by setting in "Charging source". It's not allowed to modify here. When "Grid and PV" or "Grid or PV" is selected in charging source section, this option is default selected. Under Grid-tie mode, this option is invalid.

Allow to feed-in to the Grid: This option is only valid under Grid-tie and Grid-tie with backup modes. Users can decide if this inverter can feed-in to the grid.

Allow battery to discharge when PV is available: This option is automatically determined by setting in "Load supply source (PV is available)". When "Battery" is higher priority than "Grid" in Load supply source (PV is available), this option is default selected. Under Grid-tie, this option is invalid.

Allow battery to discharge when PV is unavailable: This option is automatically determined by setting in "Load supply source (PV is unavailable)". When "Battery" is higher priority than "Grid" in Load supply source (PV is unavailable), this option is default selected. Under Grid-tie mode, this option is invalid.

Allow battery to feed-in to the Grid when PV is available: This option is only valid in Grid-tie with backup II or Grid-tie with backup III modes.

Allow battery to feed-in to the Grid when PV is unavailable: This option is only valid in all options of Grid-tie with backup mode.

## Grid-tie with backup

- Grid-tie with backup (I) :

The screenshot shows the 'MyPower Management' software interface. At the top, the mode is set to 'Grid-tie with backup'. Below this, there are settings for 'Standard' (VDE0126), 'Nominal output voltage' (230), and 'Nominal output frequency' (50). The 'Setting' section includes 'PV energy supply priority setting' with a dropdown menu set to 'Grid-Tie with Backup (I)' and a priority list 'Priority: 1st: Battery -> 2nd: Load -> 3rd: Grid'. The 'Configuration details' section has several options: 'Charging source' is 'PV and Grid', 'Load supply source (PV is available)' is 'PV-Grid-Battery', and 'Load supply source (PV is unavailable)' is 'Grid-Battery'. There are several checkboxes for battery management: 'Allow to charge battery' (checked), 'Allow AC to charge battery' (checked), 'Allow to feed-in to the Grid' (checked), 'Allow battery to discharge when PV is available' (unchecked), 'Allow battery to discharge when PV is unavailable' (unchecked), 'Allow battery to feed-in to the Grid when PV is available' (unchecked), and 'Allow battery to feed-in to the Grid when PV is unavailable' (checked). At the bottom, there are settings for 'When battery voltage < 40 V, the AC starts charging', 'Allow AC-charging duration' (00:00 to 04:00), and 'AC Output ON/OFF Timer' (00:00 / 00:00).

PV energy supply priority setting: 1<sup>st</sup> Battery, 2<sup>nd</sup> Load and 3<sup>rd</sup> Grid.

PV power will charge battery first, then provide power to the load. If there is any remaining power left, it will feed-in to the grid.

Battery charging source:

1. PV and Grid (Default)

It's allowed to charge battery from PV power first. If it's not sufficient, grid will charge battery.

2. PV only

It is only allow PV power to charge battery.

3. None

It is not allowed to charge battery no matter it's from PV power or grid.

Load supply source:

When PV power is available: 1<sup>st</sup> PV, 2<sup>nd</sup> Grid, 3<sup>rd</sup> Battery

If battery is not fully charged, PV power will charge battery first. And remaining PV power will provide power to the load. If it's not sufficient, grid will provide power to the load. If grid is not available at the same time, battery power will back up.

When PV power is not available:

1. 1<sup>st</sup> Grid, 2<sup>nd</sup> Battery (Default)

Grid will provide power to the load at first. If grid is not available, battery power will provide power backup.

2. 1<sup>st</sup> Battery, 2<sup>nd</sup> Grid

Battery power will provide power to the load at first. If battery power is running out, grid will back up the load.

NOTE: This option will become ineffective during AC charging time and the priority will automatically become 1<sup>st</sup> Grid and 2<sup>nd</sup> Battery order. Otherwise, it will cause battery damage.

● Grid-tie with backup (II) :

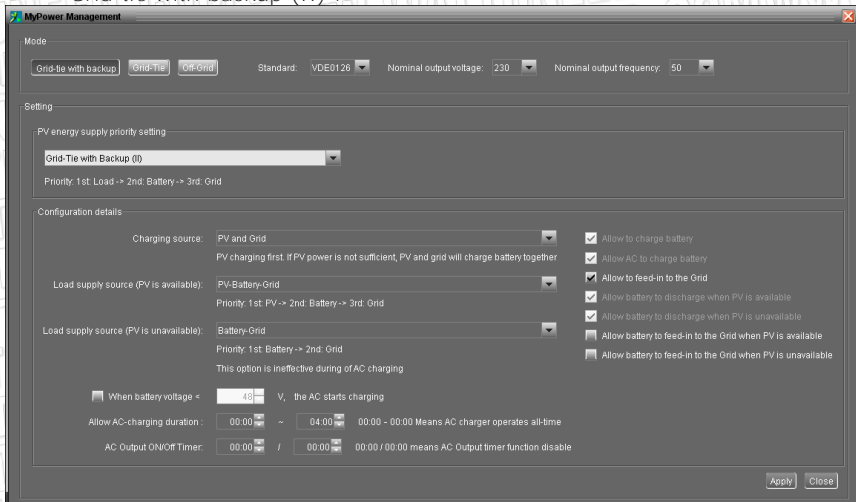

PV energy supply priority setting: 1<sup>st</sup> Load, 2<sup>nd</sup> Battery and 3<sup>rd</sup> Grid.

PV power will provide power to the load first. Then, it will charge battery. If there is any remaining power left, it will feed-in to the grid.

Battery charging source:

1. PV and Grid

It's allowed to charge battery from PV power first. If it's not sufficient, grid will charge battery.

2. PV only

It is only allow PV power to charge battery.

3. None

It is not allowed to charge battery no matter it's PV power or grid.

Load supply source:

When PV power is available:

1. 1<sup>st</sup> PV, 2<sup>nd</sup> Battery, 3<sup>rd</sup> Grid

PV power will provide power to the load first. If it's not sufficient, battery power will provide power to the load. When battery power is running out or not available, grid will back up the load.

2. 1<sup>st</sup> PV, 2<sup>nd</sup> Grid, 3<sup>rd</sup> Battery

PV power will provide power to the load first. If it's not sufficient, grid will provide power to the load. If grid is not available at the same time, battery power will back up.

When PV power is not available:

1. 1<sup>st</sup> Grid, 2<sup>nd</sup> Battery: Grid will provide power to the load at first. If grid is not available, battery power will provide power backup.

2. 1<sup>st</sup> Battery, 2<sup>nd</sup> Grid: Battery power will provide power to the load at first. If battery power is running out, grid will back up the load

NOTE: This option will become ineffective during AC charging time and the priority will automatically become 1<sup>st</sup> Grid and 2<sup>nd</sup> Battery order. Otherwise, it will cause battery damage.

## ● Grid-tie with backup (III):

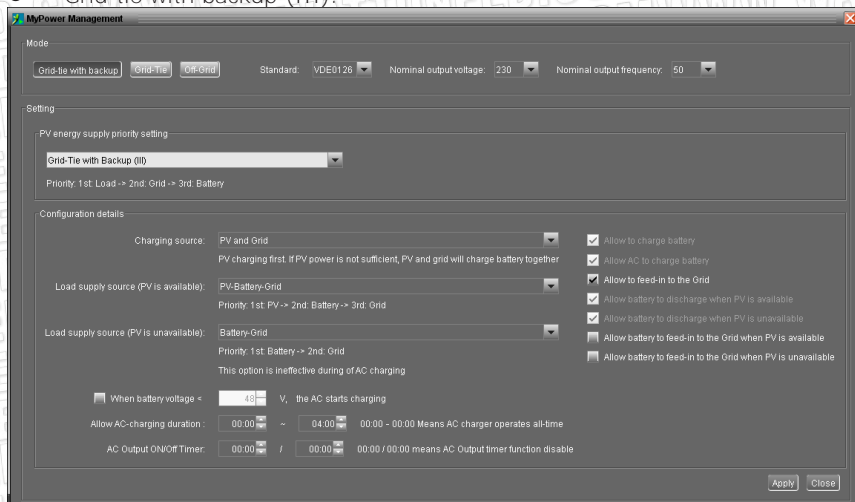

PV energy supply priority setting: 1<sup>st</sup> Load, 2<sup>nd</sup> Grid and 3<sup>rd</sup> Battery

PV power will provide power to the load first. If there is more PV power available, it will feed-in to the grid. If feed-in power reaches max. feed-in power setting, the remaining power will charge battery.

NOTE: The max. feed-in grid power setting is available in parameter setting. Please refer to software manual.

Battery charging source:

1. PV and Grid: It's allowed to charge battery from PV power first. If it's not sufficient, grid will charge battery.
2. PV only: It is only allow PV power to charge battery.
3. None: It is not allowed to charge battery no matter it's PV power or grid.

Load supply source:

When PV power is available:

1. 1<sup>st</sup> PV, 2<sup>nd</sup> Battery, 3<sup>rd</sup> Grid

PV power will provide power to the load first. If it's not sufficient, battery power will provide power to the load. When battery power is running out or not available, grid will back up the load.

2. 1<sup>st</sup> PV, 2<sup>nd</sup> Grid, 3<sup>rd</sup> Battery

PV power will provide power to the load first. If it's not sufficient, grid will provide power to the load. If grid is not available at the same time, battery power will back up.

When PV power is not available:

1. 1<sup>st</sup> Grid, 2<sup>nd</sup> Battery: Grid will provide power to the load at first. If grid is not available, battery power will provide power backup.
2. 1<sup>st</sup> Battery, 2<sup>nd</sup> Grid: Battery power will provide power to the load at first. If

battery power is running out, grid will back up the load.

NOTE: This option will become ineffective during AC charging time and the priority will automatically become 1<sup>st</sup> Grid and 2<sup>nd</sup> Battery order. Otherwise, it will cause battery damage.

- Grid-tie with backup (IV): Users are only allowed to set up peak time and off-peak electricity demand.

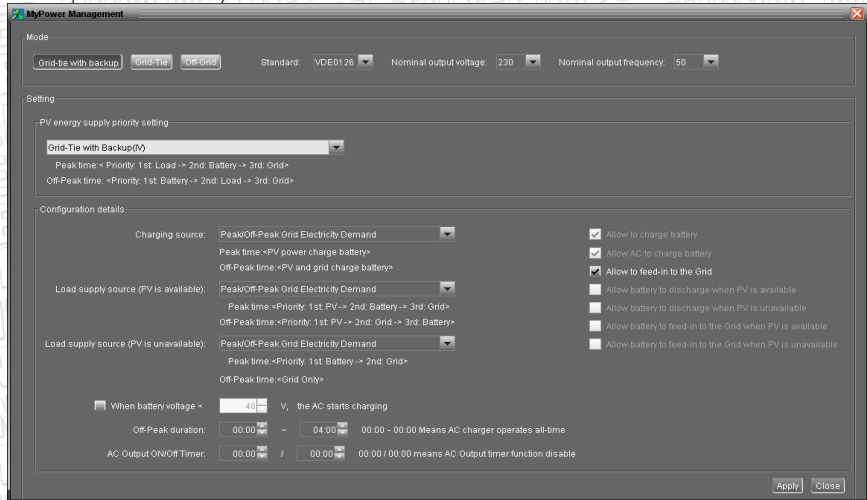

Working logic under peak time:

PV energy supply priority: 1<sup>st</sup> Load, 2<sup>nd</sup> Battery and 3<sup>rd</sup> Grid

PV power will provide power to the load first. If PV power is sufficient, it will charge battery next. If there is remaining PV power left, it will feed-in to the grid. Feed-in to the grid is default disabled.

Battery charging source: PV only

Only after PV power fully supports the load, the remaining PV power is allowed to charge battery during peak time.

Load supply source: 1<sup>st</sup> PV, 2<sup>nd</sup> Battery, 3<sup>rd</sup> Grid

PV power will provide power to the load first. If PV power is not sufficient, battery power will back up the load. If battery power is not available, grid will provide the load. When PV power is not available, battery power will supply the load first. If battery power is running out, grid will back up the load.

Working logic under off-peak time:

PV energy supply priority: 1<sup>st</sup> Battery, 2<sup>nd</sup> Load and 3<sup>rd</sup> Grid

PV power will charge battery first. If PV power is sufficient, it will provide power to the loads. The remaining PV power will feed to the grid.

NOTE: The max. feed-in grid power setting is available in parameter setting.

Please refer to software manual.

Battery charging source: PV and grid charge battery

PV power will charge battery first during off-peak time. If it's not sufficient, grid will charge battery.

Load supply source: 1<sup>st</sup> PV, 2<sup>nd</sup> Grid, 3<sup>rd</sup> Battery

When battery is fully charged, remaining PV power will provide power to the load first. If PV power is not sufficient, grid will back up the load. If grid power is not available, battery power will provide power to the load.

### Grid-Tie

Under this operation mode, PV power only feeds-in to the grid. No priority setting is available.

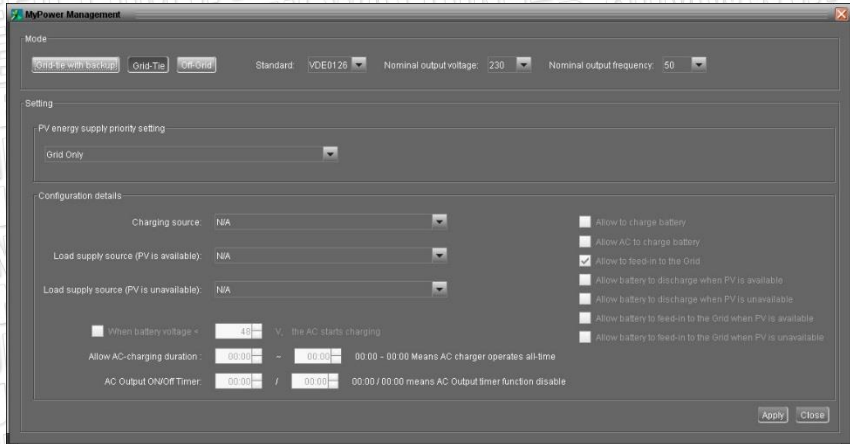

## Off-Grid

- Off-Grid (I): Default setting for off-grid mode.

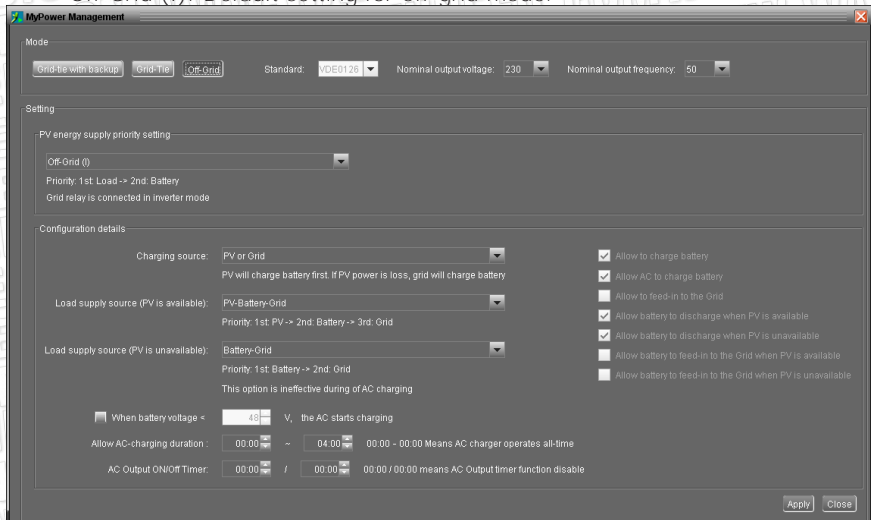

PV energy supply priority setting: 1<sup>st</sup> Load, 2<sup>nd</sup> Battery

PV power will provide power to the load first and then charge battery. Feed-in to the grid is not allowed under this mode. At the same time, the grid relay is connected in Inverter mode. That means the transfer time from inverter mode to battery mode will be less than 15ms. Besides, it will avoid overload fault because grid can supply load when connected load is over rated output capacity of the inverter.

Battery charging source:

1. PV or Grid: If there is remaining PV power after supporting the loads, it will charge battery first. Only until PV power is not available, grid will charge battery. (Default)
2. PV only: It is only allow PV power to charge battery.
3. None: It is not allowed to charge battery no matter it's PV power or grid.

Load supply source:

When PV power is available:

1. 1<sup>st</sup> PV, 2<sup>nd</sup> Battery, 3<sup>rd</sup> Grid (Default)

PV power will provide power to the load first. If it's not sufficient, battery power will provide power to the load. When battery power is running out or not available, grid will back up the load.

2. 1<sup>st</sup> PV, 2<sup>nd</sup> Grid, 3<sup>rd</sup> Battery

PV power will provide power to the load first. If it's not sufficient, grid will provide power to the load. If grid is not available at the same time, battery power will back up.

When PV power is not available:

1. 1<sup>st</sup> Grid, 2<sup>nd</sup> Battery



Grid will provide power to the load at first. If grid is not available, battery power will provide power backup.

## 2. 1<sup>st</sup> Battery, 2<sup>nd</sup> Grid (Default)

Battery power will provide power to the load at first. If battery power is running out, grid will back up the load.

NOTE: This option will become ineffective during AC charging time and the priority will automatically become 1<sup>st</sup> Grid and 2<sup>nd</sup> Battery order. Otherwise, it will cause battery damage.

## ● Off-Grid (II)

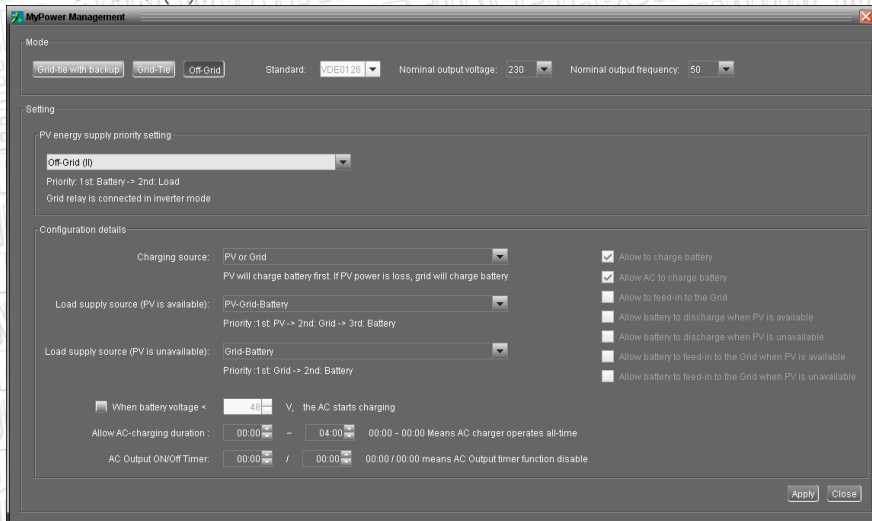

PV energy supply priority setting: 1<sup>st</sup> Battery, 2<sup>nd</sup> Load

PV power will charge battery first. After battery is fully charged, if there is remaining PV power left, it will provide power to the load. Feed-in to the grid is not allowed under this mode. At the same time, the grid relay is connected in Inverter mode. That means the transfer time from inverter mode to battery mode will be less than 15ms. Besides, it will avoid overload fault because grid can supply load when connected load is over rated output capacity of the inverter.

Battery charging source:

1. PV or Grid: If there is remaining PV power after supporting the loads, it will charge battery first. Only until PV power is not available, grid will charge battery.
2. PV only: It is only allow PV power to charge battery.
3. None: It is not allowed to charge battery no matter it's PV power or grid.

NOTE: It's allowed to set up AC charging duration.

Load supply source:

When PV power is available: 1<sup>st</sup> PV, 2<sup>nd</sup> Grid, 3<sup>rd</sup> Battery

PV power will provide power to the load first. If it's not sufficient, grid will provide power to the load. If grid is not available at the same time, battery power will back

up.

When PV power is not available:

- 1<sup>st</sup> Grid, 2<sup>nd</sup> Battery: Grid will provide power to the load at first. If grid is not available, battery power will provide power backup.
- 1<sup>st</sup> Battery, 2<sup>nd</sup> Grid: Battery power will provide power to the load at first. If battery power is running out, grid will back up the load.

NOTE: This option will become ineffective during AC charging time and the priority will automatically become 1<sup>st</sup> Grid and 2<sup>nd</sup> Battery order. Otherwise, it will cause battery damage.

### ● Off-Grid (III)

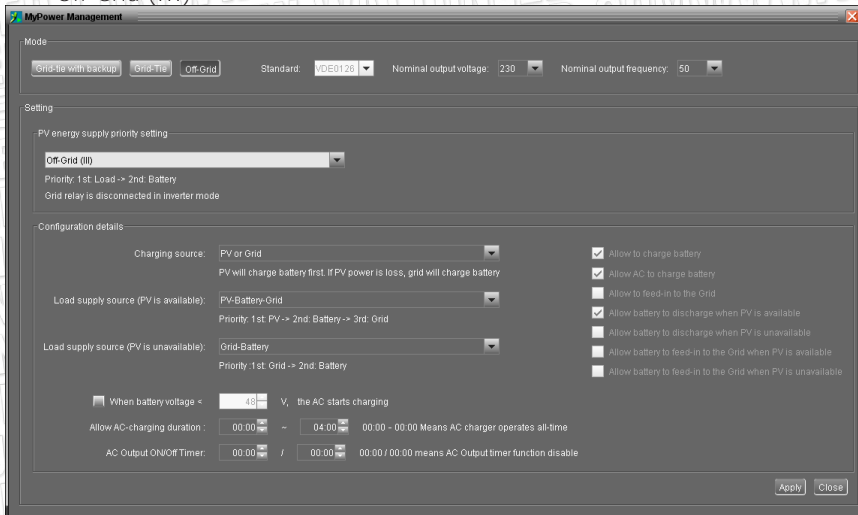

PV energy supply priority setting: 1<sup>st</sup> Load, 2<sup>nd</sup> Battery

PV power will provide power to load first and then charge battery. Feed-in to the grid is not allowed under this mode. The grid relay is NOT connected in Inverter mode. That means the transfer time from inverter mode to battery mode will be about 15ms. If connected load is over rated output capacity of the inverter and grid is available, this inverter will allow grid to provide power to the loads and PV power to charge battery. Otherwise, this inverter will activate fault protection.

Battery charging source:

1. PV or Grid: If there is remaining PV power after supporting the loads, it will charge battery first. Only until PV power is not available, grid will charge battery.
2. PV only: It is only allow PV power to charge battery.
3. None: It is not allowed to charge battery no matter it's PV power or grid.

NOTE: It's allowed to set up AC charging duration.

Load supply source:

When PV power is available: 1<sup>st</sup> PV, 2<sup>nd</sup> Battery, 3<sup>rd</sup> Grid

PV power will provide power to the load first. If it's not sufficient, battery power will back up the load. Only after battery power is running, Grid will back up the load.

When PV power is not available:

1. 1<sup>st</sup> Grid, 2<sup>nd</sup> Battery: Grid will provide power to the load at first. If grid is not available, battery power will provide power backup.
2. 1<sup>st</sup> Battery, 2<sup>nd</sup> Grid: Battery power will provide power to the load at first. If battery power is running out, grid will back up the load.

NOTE: This option will become ineffective during AC charging time and the priority will automatically become 1<sup>st</sup> Grid and 2<sup>nd</sup> Battery order. Otherwise, it will cause battery damage.

## 14. Operation

### 14-1. Interface



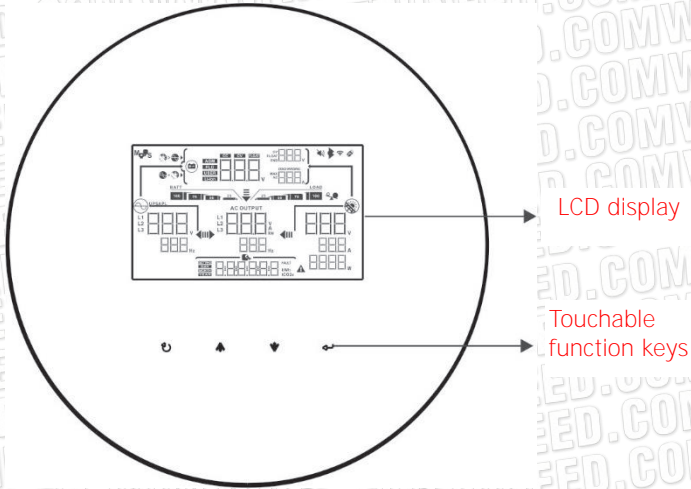





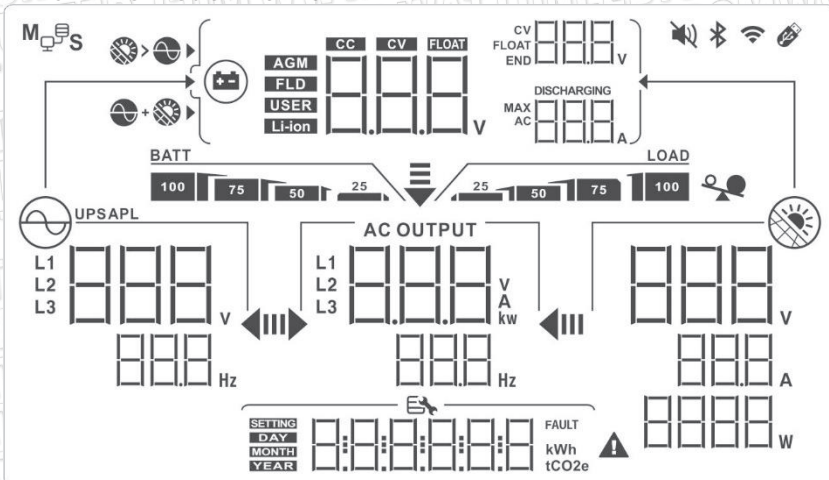

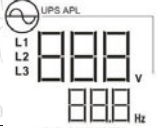

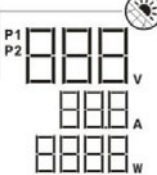

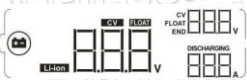
The operation LCD panel, shown in the chart below, includes four touchable function keys and a LCD display to indicate the operating status and input/output power information.



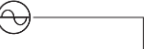



NOTICE: To accurately monitor and calculate the energy generation, please calibrate the timer of this unit via software every one month. For the detailed calibration, please check the user manual of bundled software.





### 14-2. LCD Information Define



Display	Function
	Indicates AC input voltage and frequency. V: voltage, Hz: frequency, L1/L2/L3: Line phase
	Indicates AC output power, voltage, frequency, or current. kw: active power, V: voltage, Hz: frequency, A: current L1/L2/L3: AC output phase
	Indicates PV input voltage, power or current. V: voltage, W: power, P1: PV input 1, P2: PV input 2 A: current
	Allow AC and PV charging
	Only PV charging is allowed
	Indicates battery voltage, battery current, charging status or battery parameters V: voltage, A: current, Li-ion: Lithium-ion battery type
	Indicates battery level in battery mode.
	Indicates the warning and fault codes.
	Indicates date and time or the date and time users set for querying energy generation.
	Indicates solar panels. Icon flashing indicates PV input voltage is out of range.
	Indicates utility. Icon flashing indicates utility voltage or frequency is out of range.
	Indicates battery condition. And the lattice of the icon indicates battery capacity.
	Icon  flashing indicates battery is not allowed to discharge.
	Icon  flashing indicates the battery voltage is too low.

	Indicates AC output for loads is enabled and inverter is providing power to the connected loads.
	Indicates AC output for loads is enabled but there is no power provided from inverter. At this time, no battery and the utility are available. Only PV power exists but is not able to provide power to the connected loads.
	Indicates overload.
	Indicates parallel operation is working.

### 14-3. Touchable function keys





Function Key		Operation	Function
	Enter/ON	Quick touch.	Enter query menu. If it's in query menu, touch this button to confirm selection or entry.
		Touch and hold the button for 1.5 second.	This inverter is able to provide power to connected loads via AC output connector.
	ESC/OFF	Quick touch.	Return to previous menu.
		Touch and hold the button for 1.5 second.	Turn off power to the loads.
	Up	Quick touch.	Select last selection or increase value.
	Down	Quick touch.	If it's in query menu, press this button to jump to next selection or decrease value.
			Mute alarm in standby mode or battery mode.
		Touch and hold these two buttons for 3 seconds.	Enter setting mode.

NOTE: If backlight shuts off, you may activate it by touching any button.

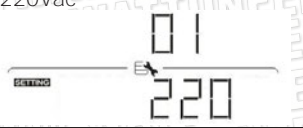
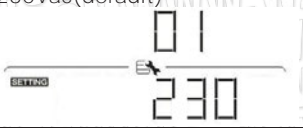
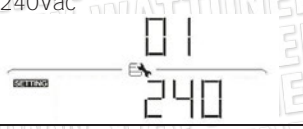
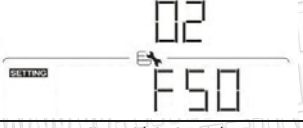
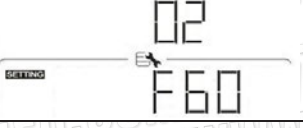
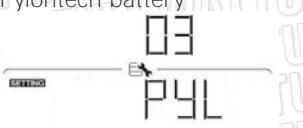
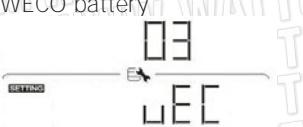
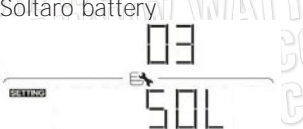

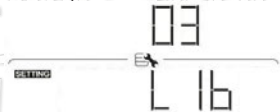



#### 14-4. LCD Setting



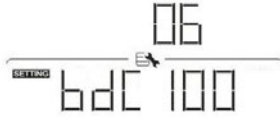

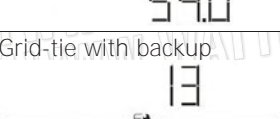
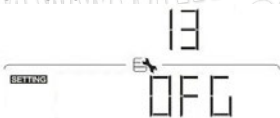
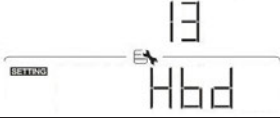

After touching and holding "UP" and "DOWN" button for 3 seconds, the unit will enter setting mode. Press "UP" or "DOWN" button to select setting programs. And then, press "ENTER" button to confirm the selection or ESC button to exit.



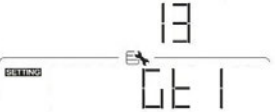

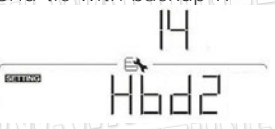



Program	Description	Selectable option	
00	Exit setting mode	Escape 	
01	Output voltage	220Vac 	230Vac(default) 
		240Vac 	
02	Output frequency	50Hz(default) 	60Hz 
		03	Battery type
Pylontech battery 	If selected, programs of 4, 7, 8 and 9 will be automatically set up. No need for further setting.		
WECO battery 	If selected, programs of 4, 7, 8 and 9 will be auto-configured per battery supplier recommended. No need for further adjustment.		
Soltaro battery 	If selected, programs of 4, 7, 8 and 9 will be automatically set up. No need for further setting.		



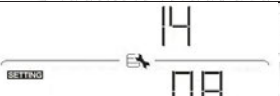



	LiB-protocol compatible battery 	Select "LiB" if using Lithium battery compatible to Lib protocol. If selected, programs of 4, 7, 8 and 9 will be automatically set up. No need for further setting.
	3 <sup>rd</sup> party Lithium battery 	If selected, programs of 4, 7, 8 and 9 will be automatically set up. No need for further setting. Please contact the battery supplier for installation procedure.
	VSC 	If selected, standard CAN protocol will be supported.
04 Maximum charging current: To configure total charging current for solar and utility chargers. (Max. charging current = utility charging current + solar charging current)	60A(default) 	For 10KW model, setting range is 1A, then from 10A to 200A. For 12KW model, setting range is 1A, then from 10A to 250A. For 15KW model, setting range is 1A, then from 10A to 300A. Increment of each click is 10A.
05 Maximum utility charging current	60A(default) 	For 10KW model, setting range is 1A, then from 10A to 200A. For 12KW model, setting range is 1A, then from 10A to 250A. For 15KW model, setting range is 1A, then from 10A to 300A. Increment of each click is 10A.



06	Maximum discharging current	100A(default) 	For 10KW/12KW model, setting range is from 10A to 300A. For 15KW model, setting range is from 10A to 370A. Increment of each click is 10A.
07	Bulk charging voltage (C.V voltage)	Default setting: 56.0V 	Setting range is from 48.0V to 60.0V. Increment of each click is 0.1V.
08	Floating charging voltage	Default setting: 54.0V 	Setting range is from 48.0V to 60.0V. Increment of each click is 0.1V.
09	Low DC cut off battery voltage setting when grid is available	Default setting: 42.0 	Setting range is from 40V to 60V. Increment of each click is 0.1V.
10	Battery re-discharging voltage when grid is available.	Default setting: 48.0 	Setting range is form 40V to 60V. Increment of each click is 0.1V
11	Low DC cut off battery voltage when grid is unavailable.	Default setting: 48.0 	Setting range is from 42V to 60V voltage. Increment of each click is 0.1V
12	Battery re-discharging voltage when grid is unavailable	Default setting: 54.0 	Setting range is from 42V to 60V voltage. Increment of each click is 0.1V
13	Operation Mode	Grid-tie with backup 	PV power can feed-in back to grid, provide power to the load and charge battery.
		Off-Grid 	PV power only provides power to the load and charge battery. No feed-in back to grid is allowed.

13	Operation Mode	Grid-Tie 	PV power only can feed-in back to grid.
14	PV energy supply priority setting	Grid-tie with backup Mode Grid-tie with backup I 	Battery-Load-Grid: PV power will charge battery first, then provide power to the load. If there is any remaining power left, it will feed-in to the grid.
		Grid-tie with backup II 	Load-Battery-Grid: PV power will provide power to the load first. Then, it will charge battery. If there is any remaining power left, it will feed-in to the grid.
		Grid-tie with backup III 	Load-Grid-Battery: PV power will provide power to the load first. If there is more PV power available, it will feed-in to the grid. If feed-in power reaches max. feed-in power setting, the remaining power will charge battery.
		Grid-tie with backup IV 	If selected, it is only allowed to set up peak time and off-peak for electricity demand. Programs of 15, 17, 18, 19 and 20 can't be set and only programs of 21, 22, 23 and 24 can be set.
		Off-Grid Mode Off-Grid I 	Load-Battery: PV power will provide power to the load first and then charge battery. Feed-in to the grid is not allowed under this mode. At the same time, the grid relay is

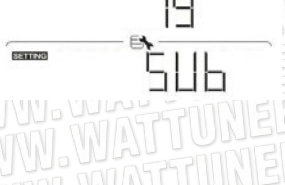
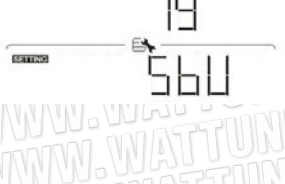
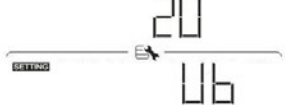
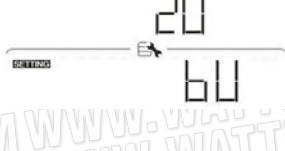
14	PV energy supply priority setting	Off-Grid II 	Battery-Load: PV power will charge battery first. After battery is fully charged, if there is remaining PV power left, it will provide power to the load. Feed-in to the grid is not allowed under this mode. At the same time, the grid relay is connected.
		Off-Grid III 	Load-Battery: PV power will provide power to load first and then charge battery. Feed-in to the grid is not allowed under this mode. The grid relay is NOT connected.
		Grid-Tie Mode 	PV power only feeds-in to the grid. No priority setting is available.
15	Charger source priority	Solar and Utility(default) 	If there is remaining PV power after supporting the loads, it will charge battery first. Only until PV power is not available, grid will charge battery.
		Only Solar 	It is only allow PV power to charge battery.
		None 	It is not allowed to charge battery no matter it's PV power or grid.
16	Feed to grid function	Feed to grid disable (default) 	Feed to grid enable 

17	Battery energy feed to grid function when PV energy is available	Battery feed to grid disable (default) 	Battery feed to grid enable 
18	Battery energy feed to grid function when PV energy is unavailable.	Battery feed to grid disable (default) 	Feed to grid enable 
19	Load supply source (PV is available)	SUB(default) 	Solar-grid-battery: PV power will provide power to the load first. If it's not sufficient, grid will provide power to the load. If grid is not available at the same time, battery power will back up.
		SBU 	Solar-Battery-Grid: PV power will provide power to the load first. If it's not sufficient, battery power will provide power to the load. When battery power is running out or not available, grid will back up the load.
20	Load supply source (PV is unavailable)	UB(default) 	Grid-Battery: Grid will provide power to the load at first. If grid is not available, battery power will provide power backup.
		BU 	Battery-Grid: Battery power will provide power to the load at first. If battery power is running out, grid will back up the load. This setting is ineffective during of AC charging.
21	Start charging time for first duration of AC charge	00:00 (Default) 	The setting range of start charging time for AC charger is from 00:00 to 23:00. Increment of each click is 1 hour.

22	Stop charging time for first duration of AC charge	00:00 (Default) 22 560000	The setting range of stop charging time for AC charger is from 00:00 to 23:00. Increment of each click is 1 hour.
23	Start charging time for second duration of AC charge	00:00 (Default) 23 56A000	The setting range of start charging time for AC charger is from 00:00 to 23:00. Increment of each click is 1 hour.
24	Stop charging time for second duration of AC charge	00:00 (Default) 24 560000	The setting range of start charging time for AC charger is from 00:00 to 23:00. Increment of each click is 1 hour.
25	Scheduled time for AC output on	00:00 (Default) 25 000000	The setting range of AC output on is from 00:00 to 23:00. Increment of each click is 1 hour.
26	Scheduled time for AC output off	00:00 (Default) 26 0F0000	The setting range of AC output off is from 00:00 to 23:00. Increment of each click is 1 hour.
27	LCD off waiting time	LCD is always on 27 LCD 0	The LCD turns off after 30s 27 LCD 30
		The LCD turns off after 60s(default) 27 LCD 60	The LCD turns off after 300s. 27 LCD 300
		The LCD turns off after 600s 27 LCD 600	
28	Alarm control	Alarm on(default) 28 60N	Alarm off 28 60F

29	Alarm control at standby mode	Alarm on in standby mode(default) 29 SEBON	Alarm off in standby mode 29 SEBOF
30	Alarm control at battery mode	Alarm on in battery mode (default) 30 bEbON	Alarm off in battery mode 30 bEbOF
31	Activate lithium battery when the device is powered on	Activate lithium battery enable(default) 31 bAd	Activate lithium battery disable 31 bAE
32	AC output mode	Single: This inverter is used in single phase application (default) 32 S IG	Parallel: This inverter is operated in parallel system. 32 PARL
33	Generator as AC source	Disable(default) 33 dG d IS	Enable 33 dG EN
34	Wide AC input range	Disable(default) 34 wAC d IS	Enable 34 wAC EN
35	N/G relay close in battery mode	Disable (default) 35 NG d	Enable 35 NGE
39	Time setting – Minute	39 n IN 00	For minute setting, the range is from 00 to 59.

40	Time setting – Hour		For hour setting, the range is from 00 to 23.
41	Time setting – Day		For day setting, the range is from 00 to 31.
42	Time setting – Month		For month setting, the range is from 01 to 12.
43	Time setting – Year		For year setting, the range is from 17 to 99.

#### 14-5: LCD Display Information

There are two ways to change LCD display information: Query menu and pressing "▲" or "▼" to switch displayed information.

#### Query Menu Operation

The display shows current contents that have been set. The displayed contents can be changed in query menu via button operation. Press 'Enter' button to enter query menu.

There are seven query selections:

- Input voltage or frequency of AC input.
- Frequency, voltage or power of AC output.
- Input voltage or power of PV input.

#### Setting Display Procedure

- Input voltage or frequency of AC input

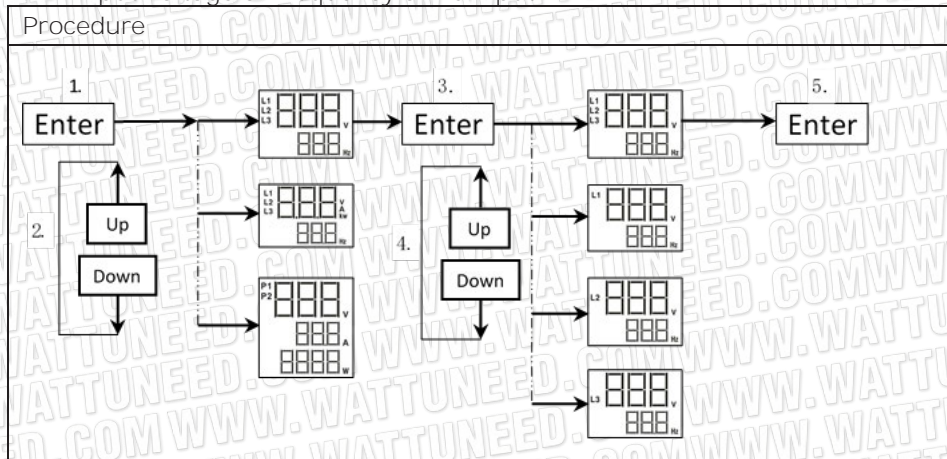

● Frequency, voltage or power of AC output

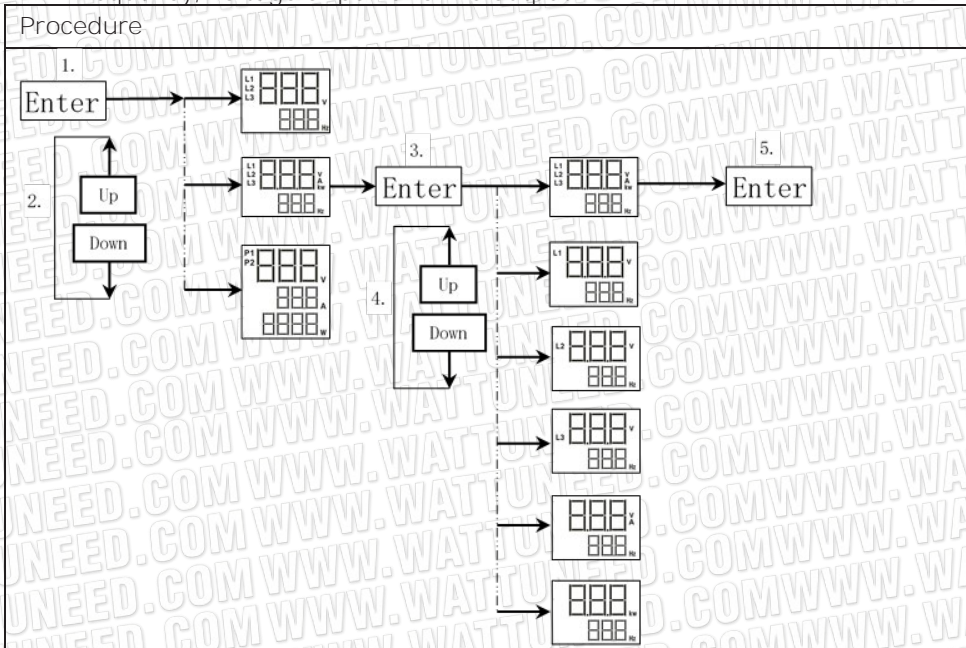

● Input voltage or power of PV input

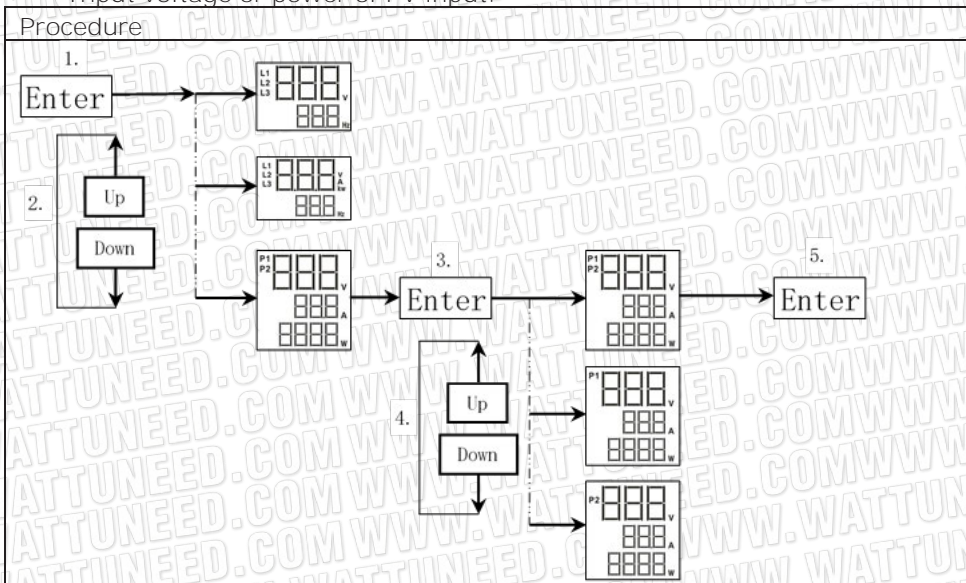



## Switch LCD Displayed Information

The LCD display information will be switched in turns by pressing "▲" or "▼" key. The selectable information is switched as the following table in order.

Selectable information	LCD display
Real date	<p>Real date : 2020-08-18</p>
Real time	<p>Real time : 10:08</p>
PV energy generated today	<p>PV energy generated today = 8Wh.</p>

PV energy generated this month = 8kWh.

PV energy generated this month

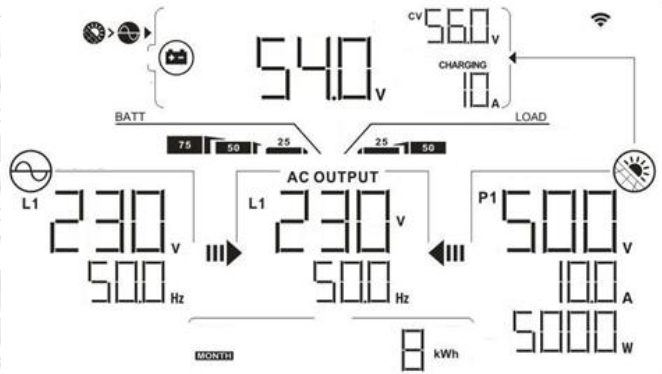

PV energy generated this year = 108kWh

PV energy generated this year

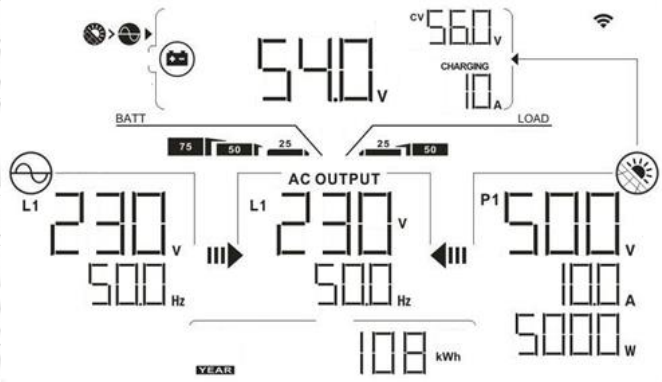

Total PV energy generated = 108kWh

Total PV energy generated

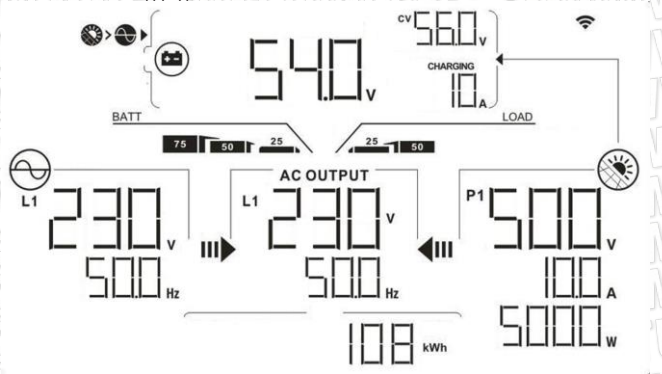

Main CPU version 01.01.

Main CPU version checking.

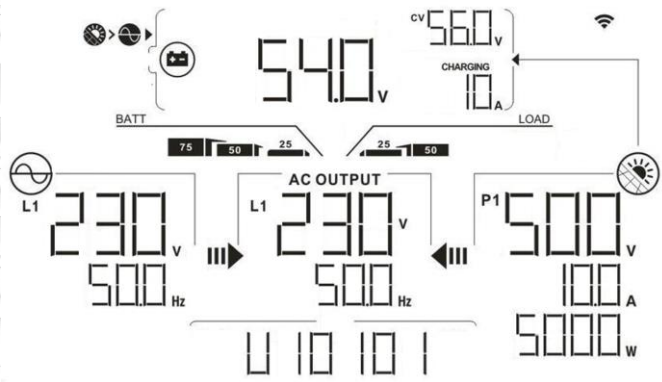

Secondary CPU version 01.01.

Secondary CPU version checking.



Remote version 16.00

Remote version checking.

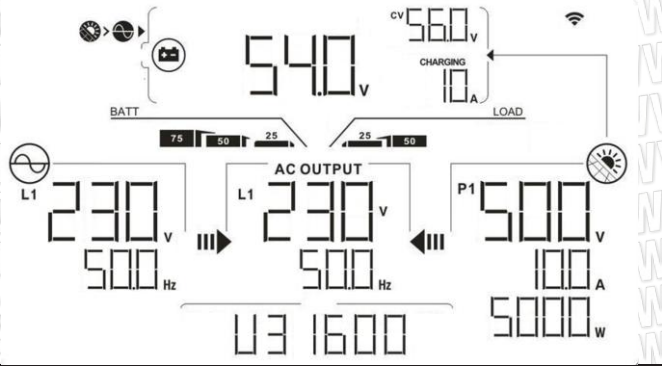

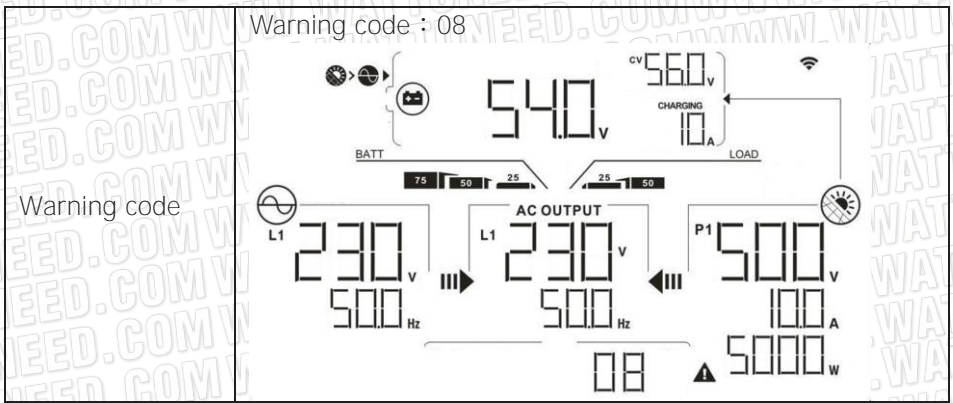

### 14-6. Operation Mode & Display

Below is only contained LCD display for grid-tie with backup mode (I). If you need to know other operation mode with LCD display, please check with installer.

#### Inverter mode with grid connected

This inverter is connected to grid and working with DC/INV operation.

LCD Display	Description
	<p>PV power is sufficient to charge battery, provide power to loads, and then feed in to the grid.</p>
	<p>PV power is sufficient to charge the battery first. However, remaining PV power is not sufficient to back up the load. Therefore, remaining PV power and the utility are supplying power to the connected load.</p>

	<p>PV power is generated, but not sufficient enough to charge battery by itself. PV power and the utility are charging battery at the same time. And the utility is also supplying power to the connected load.</p>
	<p>This inverter is disabled to generate power to the loads via AC output. PV power is sufficient to charge battery first. Remaining PV power will feed in back to grid.</p>
	<p>This inverter is disabled to generate power to the loads via AC output. PV power and utility are charging battery at the same time because of insufficient PV power.</p>
	<p>This inverter is disabled to generate power to the loads via AC output. PV power is feeding power back to the grid.</p>
	<p>PV power is sufficient to provide power to loads and feed power back to the grid.</p>

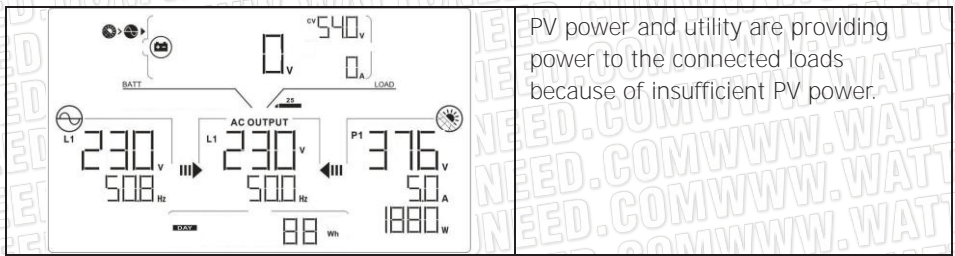

**Inverter mode without grid connected**

This inverter is working with DC/INV operation and not connecting to the grid.

LCD Display	Description
	<p>PV power is sufficient to charge battery and provide power to the connected loads.</p>
	<p>PV power is generated, but not sufficient to power loads by itself. PV power and battery are providing power to the connected loads at the same time.</p>
	<p>Only battery power is available to provide power to connected loads.</p>

### Bypass mode

The inverter is working without DC/INV operation and connecting to the loads.

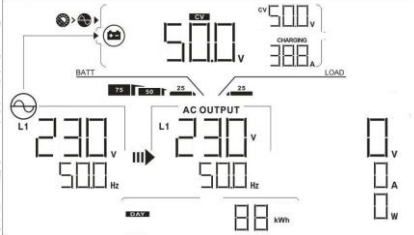
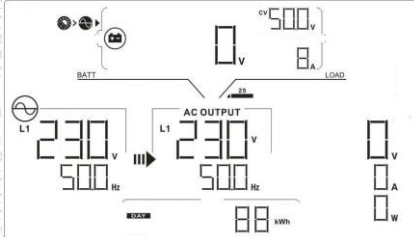
LCD Display	Description
 <p>The LCD display shows a DC input of 500V and a charging current of 388A. The AC output is 230V at 500Hz. The battery level is 88 kWh. The inverter is bypassed, indicated by the 'BYPASS' icon.</p>	<p>Only utility is charging battery and providing power to connected loads.</p>
 <p>The LCD display shows a DC input of 0V and a charging current of 8A. The AC output is 230V at 500Hz. The battery level is 88 kWh. The inverter is bypassed, indicated by the 'BYPASS' icon.</p>	<p>Only utility is available to provide power to connected loads.</p>

### Standby mode :

The inverter is working without DC/INV operation and load connected.

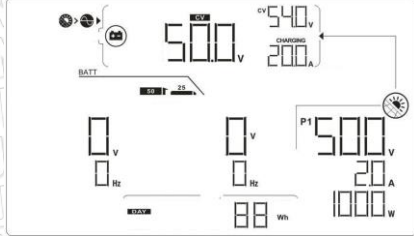
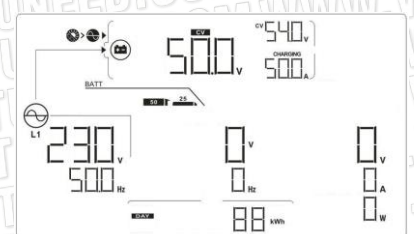
LCD Display	Description
 <p>The LCD display shows a DC input of 500V and a charging current of 200A. The AC output is 500V at 20A. The battery level is 88 kWh. The inverter is disabled, indicated by the 'OFF' icon.</p>	<p>This inverter is disabled on AC output or even AC power output is enabled, but an error occurs on AC output. Only PV power is sufficient to charge battery.</p>
 <p>The LCD display shows a DC input of 500V and a charging current of 500A. The AC output is 230V at 500Hz. The battery level is 88 kWh. The inverter is disabled, indicated by the 'OFF' icon.</p>	<p>This inverter is disabled to generate power to the loads via AC output. PV power is not detected or available at this moment. Only utility is available to charge battery.</p>

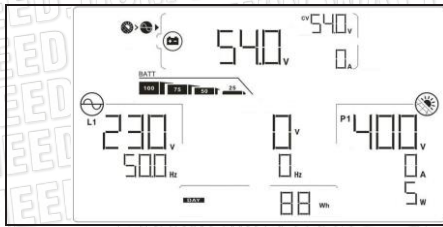

If PV, battery or utility icons are flashing, it means they are not within acceptable working range. If they are not displayed, it means they are not detected.

## 15. Charging Management

Charging Parameter	Default Value	Note
Charging current	60A	For 12KW model, it can be adjusted via software from 10Amp to 250Amp. For 15KW model, it can be adjusted via software from 10Amp to 300Amp.
Floating charging voltage (default)	54.0 Vdc	It can be adjusted via software from 50Vac to 60Vdc.
Max. absorption charging voltage (default)	56.0 Vdc	It can be adjusted via software from 50Vac to 60Vdc.
Battery overcharge protection	62.0 Vdc	
<p>Charging process based on default setting.</p> <p>3 stages:</p> <p>First – max. charging voltage increases to 56V;</p> <p>Second- charging voltage will maintain at 56V until charging current is down to 12 Amp;</p> <p>Third- go to floating charging at 54V.</p>		

This inverter can connect to battery types of sealed lead acid battery, vented battery, gel battery and lithium battery. The detail installation and maintenance explanations of the external battery pack are provided in the manufacturer's external battery pack of manual.



If using sealed lead acid battery, please set up the max. charging current according to below formula:

$$\text{The maximum charging current} = \text{Battery capacity (Ah)} \times 0.2$$

For example, if you are using 300 Ah battery, then, maximum charging current is  $300 \times 0.2 = 60$  (A). Please use at least 50Ah battery because the settable minimum value of charging current is 10A. If using AGM/Gel or other types of battery, please consult with installer for the details.

Below is setting screen from software:

**Parameters setting**

Min. grid-connected voltage: 184 V	Apply	The waiting time before grid-connection: 60 Sec.	Apply
Max. grid-connected voltage: 264.5 V	Apply	Max. grid-connected average voltage: 253 V	Apply
Min. grid-connected frequency: 47.48 Hz	Apply	Max. feed-in grid power: 10,000 W	Apply
Max. grid-connected frequency: 51.5 Hz	Apply		
Min. PV input voltage: 300 V	Apply	<b>Floating charging voltage: 54 V</b>	<b>Apply</b>
Max. PV input voltage: 900 V	Apply	Battery cut-off discharging voltage when Grid is available: 48 V	Apply
Min. MPP voltage: 350 V	Apply	Battery re-discharging voltage when Grid is available: 54 V	Apply
Max. MPP voltage: 850 V	Apply	Battery cut-off discharging voltage when Grid is unavailable: 42 V	Apply
<b>Max. charging current: 60 A</b>	<b>Apply</b>	Battery re-discharging voltage when Grid is unavailable: 48 V	Apply
Max. AC charging current: 60 A	Apply	Battery temperature compensation: 0 mV	Apply
<b>Bulk charging voltage(C.V. voltage): 56 V</b>	<b>Apply</b>	Feeding grid power calibration: 0 W	Apply
Start LCD screen-saver after: None Sec.	Apply	Max. battery discharge current in hybrid mode: 10 A	Apply

Mute Buzzer alarm:  Enable  Disable **Apply**

Mute the buzzer in the Standby mode:  Enable  Disable **Apply**

Mute alarm in battery mode:  Enable  Disable **Apply**

Generator as AC source:  Enable  Disable **Apply**

Activate Li-Fe battery while commissioning:  Yes  No **Apply**

Wide AC input range:  Enable  Disable **Apply**

When float charging current is less than X (A) and continued T (Min),then charger off; when battery voltage is less than Y (V),then charger on again.

X: 0 A T: 60 Min. Y: 53 V **Apply**

Any schedule change will affect the power generated and shall be conservatively made.

System time: 2014-10-27

14:03:21 **Apply**

**Close**

## 16. Maintenance & Cleaning

Check the following points to ensure proper operation of whole solar system at regular intervals.

- Ensure all connectors of this inverter are cleaned all the time.
- Before cleaning the solar panels, be sure to turn off PV DC breakers.
- Clean the solar panels, during the cool time of the day, whenever it is visibly dirty.
- Periodically inspect the system to make sure that all wires and supports are securely fastened in place.

**WARNING:** There are no user-replaceable parts inside of the inverter. Do not attempt to service the unit yourself.

### Battery Maintenance

- Servicing of batteries should be performed or supervised by personnel knowledgeable about batteries and the required precautions.
- When replacing batteries, replace with the same type and number of batteries or battery packs.
- The following precautions should be observed when working on batteries:
  - a) Remove watches, rings, or other metal objects.
  - b) Use tools with insulated handles.
  - c) Wear rubber gloves and boots.
  - d) Do not lay tools or metal parts on top of batteries.
  - e) Disconnect charging source prior to connecting or disconnecting battery terminals.
  - f) Determine if battery is inadvertently grounded. If inadvertently grounded, remove source from ground. Contact with any part of a grounded battery can result in electrical shock. The likelihood of such shock can be reduced if such grounds are removed during installation and maintenance (applicable to equipment and remote battery supplies not having a grounded supply circuit).

**CAUTION:** A battery can present a risk of electrical shock and high short-circuit current.

**CAUTION:** Do not dispose of batteries in a fire. The batteries may explode.

**CAUTION:** Do not open or mutilate batteries. Released electrolyte is harmful to the skin and eyes. It may be toxic.

## 17. Trouble Shooting

When there is no information displayed in the LCD, please check if PV module/battery/grid connection is correctly connected.

NOTE: The warning and fault information can be recorded by remote monitoring software.

### 17-1. Warning List

There are 20 situations defined as warnings. When a warning situation occurs,  icon

will flash and  will display warning code. If there are several codes, it will display in sequences. Please contact your installer when you couldn't handle with the warning situations.

Code	Warning Event	Icon (flashing)	Description
01	Line voltage high loss		Grid voltage is too high.
02	Line voltage low loss		Grid voltage is too low.
03	Line frequency high loss		Grid frequency is too high.
04	Line frequency low loss		Grid frequency is too low.
05	Line voltage loss for long time		Grid voltage is higher than 253V.
06	Ground Loss		Ground wire is not detected.
07	Island detect		Island operation is detected.
08	Line waveform loss		The waveform of grid is not suitable for inverter.
09	Line phase loss		The phase of grid is not in right sequence.
10	EPO detected		EPO is open.
11	Overload		Load exceeds rating value.
12	Over temperature		The temperature is too high inside.
13	Batter voltage low		Battery discharges to low alarm point.
14	Battery under-voltage when grid is loss		Battery discharges to shutdown point.
15	Battery open		Battery is unconnected or too low.
16	Battery under-voltage when grid is OK		Battery stops discharging when the grid is OK.
17	Solar over voltage		PV voltage is too high.
b1	Stop discharging battery		Informs inverter to stop discharging battery.
b2	Stop charging battery		Informs inverter to stop charging battery
b3	Charge battery		Informs inverter to charge battery.

## 17-2. Fault Reference Codes

When a fault occurs, the icon **FAULT** will flash as a reminder. See below for fault codes for reference.

Fault Code	Situation		Solution
	Fault Event	Possible cause	
01	Bus voltage over	Surge	1. Restart the inverter. 2. If the error message still remains, please contact your installer.
02	BUS voltage under	PV or battery disconnect suddenly	1. Restart the inverter 2. If the error message still remains, please contact your installer.
03	BUS soft start time out	Internal components failed.	Please contact your installer.
04	INV soft start time out	Internal components failed.	Please contact your installer.
05	INV over current	Surge	1. Restart the inverter. 2. If the error message still remains, please contact your installer.
06	Over temperature	Internal temperature is too high.	1. Check the ambient temperature and fans. 2. If the error message still remains, please contact your installer.
07	Relay fault	Internal components failed.	Please contact your installer.
08	CT sensor fault	Internal components failed.	Please contact your installer.
09	Solar input power abnormal	1. Solar input driver damaged. 2. Solar input power is too much when voltage is more than 850V.	1. Please check if solar input voltage is higher than 850V. 2. Please contact your installer.
11	Solar over current	Surge	1. Restart the inverter. 2. If the error message still remains, please contact your installer.

12	GFCI fault	Leakage current exceeds the limit.	1. Check the wire and panels which may cause the leakage.
13	PV ISO fault	The resistance between PV and ground is too low.	2. If the error message still remains, please contact your installer.
14	INV DC current over	Utility fluctuates.	1. Restart the inverter. 2. If the error message still remains, please contact your installer.
16	GFCI sensor fault	GFCI sensor failed.	Please contact your installer.
22	Battery high voltage fault	Battery voltage exceeds the limit.	1. Check the battery voltage. 2. If the error message still remains, please contact your installer.
23	Overload	The inverter is loaded with more than 110% load and time is up.	Reduced the connected load by switching off some equipment.
26	INV short	Output short circuited.	Check if wiring is connected well and remove abnormal load.
27	Fan lock	Fan failed.	Please contact your installer.
32	DC/DC over current	Internal components failed.	1. Restart the inverter. 2. If the error message still remains, please contact your installer.
33	INV voltage low	Internal components failed.	Please contact your installer.
34	INV voltage high	Internal components failed.	Please contact your installer.
36	OP voltage fault	Grid connects to output terminal.	Don't connect the grid to the output terminal.
38	Short circuit on PV input	Short circuited on PV input	Please contact your installer.
46	RS inverter short circuit	Short circuited on RS inverter	Check if all wiring is connected well and remove abnormal loads.
47	ST inverter short circuit	Short circuited on ST inverter	Check if all wiring is connected well and remove abnormal loads.
48	TR inverter short circuit	Short circuited on TR inverter	Check if all wiring is connected well and remove abnormal loads.

49	BUCK BOOST is over temperature	BUCK BOOST temperature is too high.	<ol style="list-style-type: none"> <li>1. Check the ambient temperature and fans.</li> <li>2. If the error message still remains, please contact your installer.</li> </ol>
50	Relay version error	Internal components failed.	Please contact your installer.
52	PV1 Over temperature	PV1 temperature is too high.	<ol style="list-style-type: none"> <li>1. Check the ambient temperature and fans.</li> <li>2. If the error message still remains, please contact your installer.</li> </ol>
53	DC/DC board of internal battery is over temperature	The temperature of DC/DC board in internal battery is too high.	<ol style="list-style-type: none"> <li>1. Check the ambient temperature and fans.</li> <li>2. If the error message still remains, please contact your installer.</li> </ol>
54	Inverter over temperature	Inverter temperature is too high.	<ol style="list-style-type: none"> <li>1. Check the ambient temperature and fans.</li> <li>2. If the error message still remains, please contact your installer.</li> </ol>
56	DCDC is over temperature	DCDC temperature is too high.	<ol style="list-style-type: none"> <li>1. Check the ambient temperature and fans.</li> <li>2. If the error message still remains, please contact your installer.</li> </ol>
57	Control board is over temperature	Control panel temperature is too high.	<ol style="list-style-type: none"> <li>1. Check the ambient temperature and fans.</li> <li>2. If the error message still remains, please contact your installer.</li> </ol>
58	External battery is over temperature	The temperature of external battery is too high.	<ol style="list-style-type: none"> <li>1. Check the ambient temperature and fans.</li> <li>2. If the error message still remains, please contact your installer.</li> </ol>
59	DC/DC board of battery is over temperature.	The temperature of DC/DC board in battery is too high.	<ol style="list-style-type: none"> <li>1. Check the ambient temperature and fans.</li> <li>2. If the error message still remains, please contact your installer.</li> </ol>

## 18. Specifications

MODEL	10KW	12KW	15KW
RATED POWER	10000 W	12000 W	15000 W
<b>PV INPUT (DC)</b>			
Maximum DC Power	14500 W	16000 W	22500 W
Nominal DC Voltage	720 VDC		
Maximum DC Voltage	1000 VDC		
Working DC Voltage Range	300 VDC ~ 1000 VDC		
Start-up Voltage / Initial Feeding Voltage	320 VDC / 350 VDC		
MPP Voltage Range / Full Load MPP Voltage Range	350 VDC ~ 950 VDC / 348 VDC ~ 900 VDC		
Maximum Input Current	27A + 27A		
Isc PV (absolute maximum)	30 A		
Max. inverter back feed current to the array	0 A		
<b>GRID OUTPUT (AC)</b>			
Nominal Output Voltage	230 VAC (P-N) / 400 VAC (P-P)		
Output Voltage Range	184 - 265 VAC per phase		
Output Frequency Range	47.5 ~ 51.5 Hz or 59.3~ 60.5Hz		
Nominal Output Current	14.5A per phase	17.4A per phase	21.7A per phase
Inrush Current/Duration	22 A per phase / 20ms		
Maximum Output Fault Current/Duration	66 A per phase / 1ms		
Maximum output Overcurrent Protection	66 A per phase		
Power Factor Range	0.9 lead ~ 0.9 lag		
<b>AC INPUT</b>			
AC Start-up Voltage	120-140 VAC per phase		
Auto Restart Voltage	180 VAC per phase		
Acceptable Input Voltage Range	170 - 290 VAC per phase		
Nominal Frequency	50 Hz / 60 Hz		
AC Input Power	10KVA/10KW	12KVA/12KW	15KVA/15KW
Maximum AC Input Current	40 A		
Inrush Input Current	40 A / 1ms		
<b>BATTERY MODE OUTPUT (AC)</b>			
Nominal Output Voltage	230 VAC (P-N) / 400 VAC (P-P)		
Output Frequency	50 Hz / 60 Hz (auto sensing)		
Output Waveform	Pure sine wave		
Output Power	10KVA/10KW	12KVA/12KW	15KVA/15KW
Efficiency (DC to AC)	91%		
<b>BATTERY &amp; CHARGER (Lead-acid/Li-ion)</b>			
DC Voltage Range	40 – 62 VDC		
Nominal DC Voltage	48 VDC		
Maximum Battery Discharging Current	250 A	300 A	375 A
Maximum Charging Current	200 A	250 A	300 A
<b>GENERAL</b>			
<b>PHYSICAL</b>			
Dimension, D X W X H (mm)	255 x 660 x 750		
Net Weight (kgs)	70	70	73
<b>INTERACE</b>			

Communication Port	RS-232/USB/RS485/CAN/WI-FI
Intelligent Slot	Optional SNMP, Modbus cards available
ENVIRONMENT	
Protective Class	I
Ingress Protection Rating	IP65
Humidity	0 ~ 100% RH (No condensing)
Operating Temperature	-25 to 60°C (Power derating above 45°C)
Altitude	Max. 1000m*

\* Power derating 1% every 100m when altitude is over 1000m.



# Appendix I: Parallel Installation Guide

## Introduction

This inverter can be used in parallel with maximum 6 units.

## Parallel cable

You will find the following items in the package:

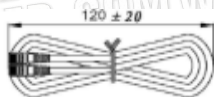

Parallel communication cable



Current sharing cable

## Overview

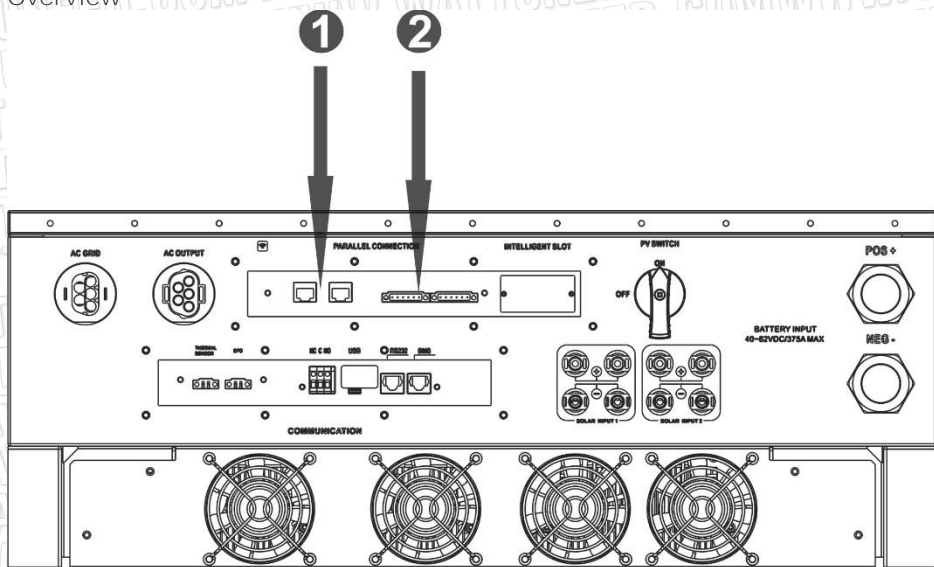

1. Parallel communication port
2. Current sharing port

## Mounting the Unit

When installing multiple units, please follow below chart.

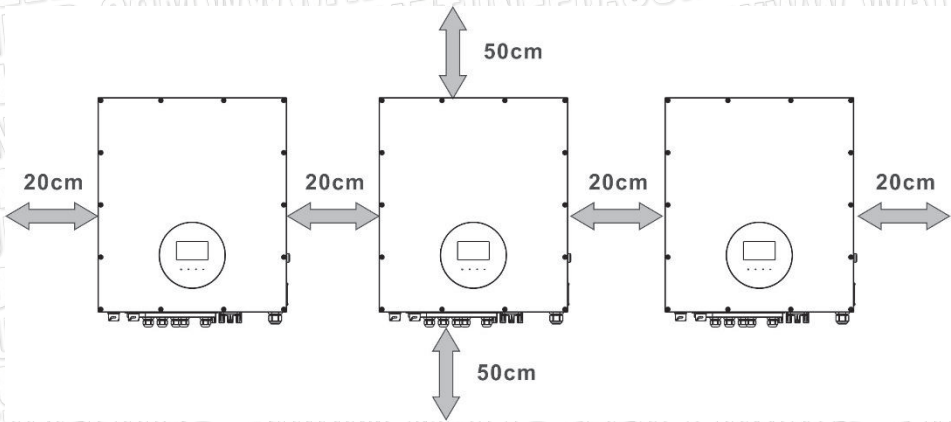

NOTE: For proper air circulation to dissipate heat, it's necessary to allow a clearance of approx. 50 cm to the side and approx. 20 cm above and below the unit. Be sure to install each unit in the same level.

## Wiring Connection

The cable size of each inverter is shown as below:

Recommended battery cable and terminal size for each inverter:

Ring terminal:

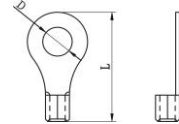

Model	Wire Size	Ring Terminal		Torque value	
		Cable mm <sup>2</sup>	Dimensions		
			D (mm)	L (mm)	
10KW/12KW	4/0	107	8.4	54.2	7~12 Nm
15KW	300	151	8.4	54.2	7~12 Nm

WARNING: Be sure the length of all battery cables is the same. Otherwise, there will be voltage difference between inverter and battery to cause parallel inverters not working.

Recommended AC input and output cable size for each inverter:

Model	AWG no.	Conductor cross-section	Torque
10KW/12KW/15KW	10~8 AWG	5.5~10 mm <sup>2</sup>	1.4~1.6Nm

You need to connect the cables of each inverter together. Take the battery cables for example. You need to use a connector or bus-bar as a joint to connect the battery cables together, and then connect to the battery terminal. The cable size used from joint to battery should be X times cable size in the tables above. "X" indicates the number of

inverters connected in parallel.

Regarding cable size of AC input and output, please also follow the same principle.

**CAUTION!!** Please install a breaker at the battery side. This will ensure the inverter can be securely disconnected during maintenance and fully protected from overcurrent of battery.

Recommended breaker specification of battery for each inverter:

Model	One unit*
10KW/12KW	350A/60VDC
15KW	450A/60VDC

\*If you want to use only one breaker at the battery side for the whole system, the rating of the breaker should be X times current of one unit. "X" indicates the number of inverters connected in parallel.

Recommended battery capacity

Inverter parallel numbers	2	3	4	5	6
Battery Capacity	800AH	1200AH	1600AH	2000AH	2400AH

**CAUTION!** Please follow the battery charging current and voltage from battery spec to choose the suitable battery. The wrong charging parameters will reduce the battery lifecycle sharply.

Approximate back-up time table

Load (W)	Backup Time @ 48Vdc 800Ah (min)	Backup Time @ 48Vdc 1200Ah (min)	Backup Time @ 48Vdc 1600Ah (min)	Backup Time @ 48Vdc 2000Ah (min)	Backup Time @ 48Vdc 2400Ah (min)
5,000	240	360	480	600	720
10,000	112	168	224	280	336
15,000	60	90	120	150	180
20,000	40	60	80	100	120
25,000	20	30	40	50	60
30,000	16	24	32	40	48

PV Connection

Please refer to user manual of single unit for PV Connection.

**CAUTION:** Each inverter should connect to PV modules separately.

## Inverters Configuration

Two inverters in parallel:

Power Connection

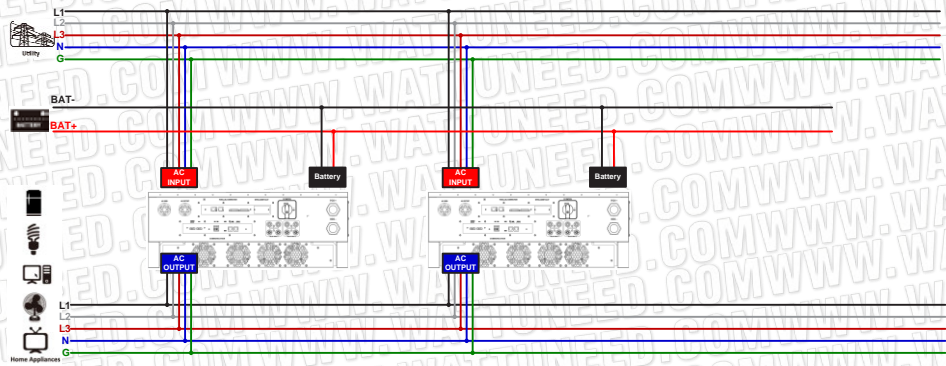

Communication Connection

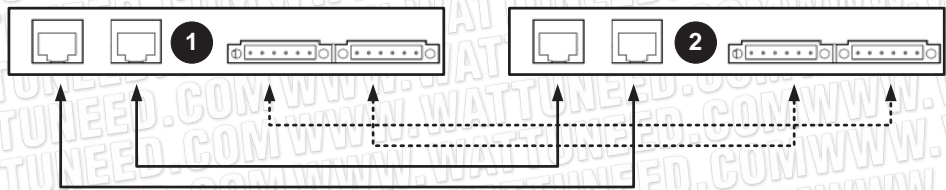

Three inverters in parallel:

Power Connection

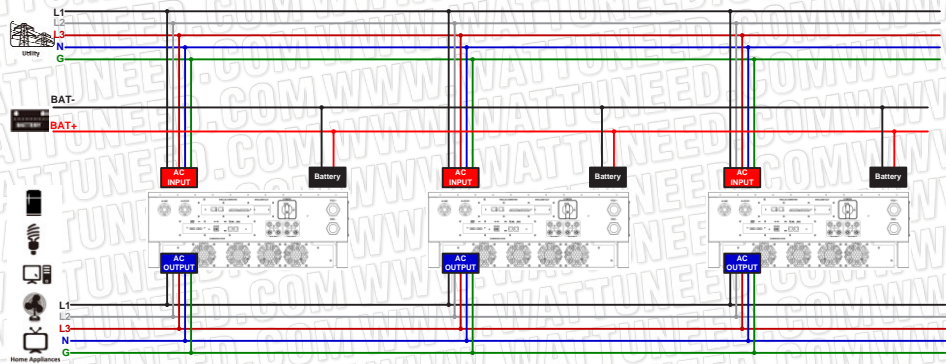

Communication Connection

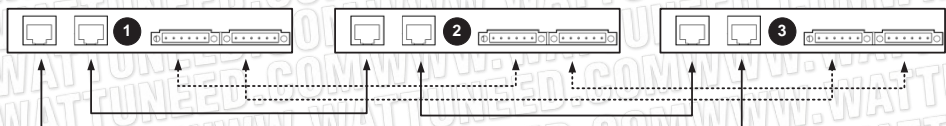

### Four inverters in parallel:

#### Power Connection

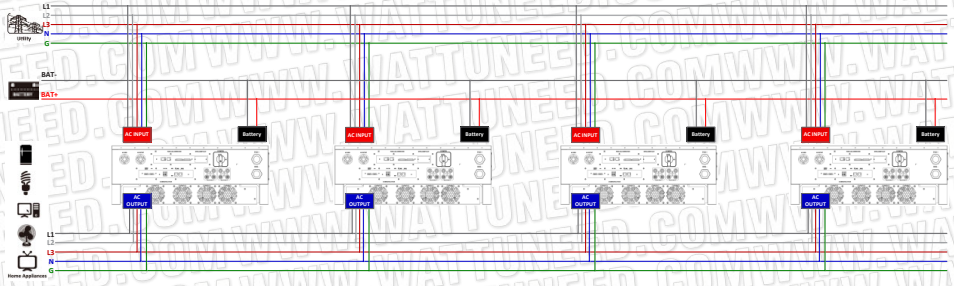

#### Communication Connection

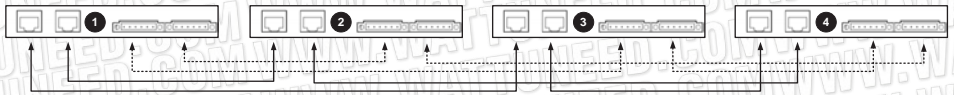

### Five inverters in parallel:

#### Power Connection

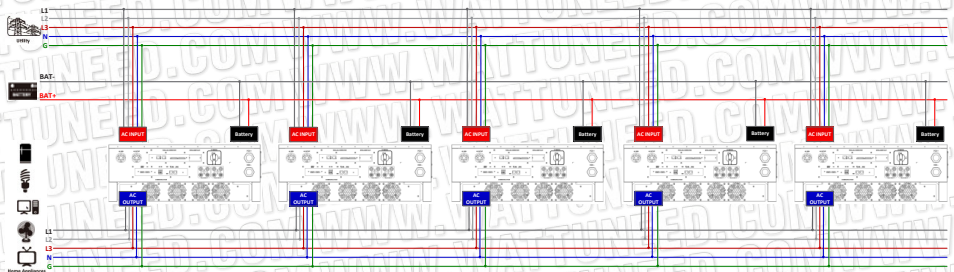

#### Communication Connection

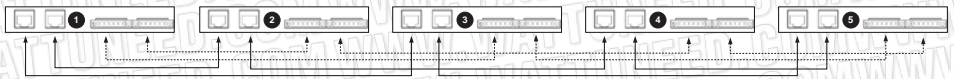

Six inverters in parallel:

Power Connection

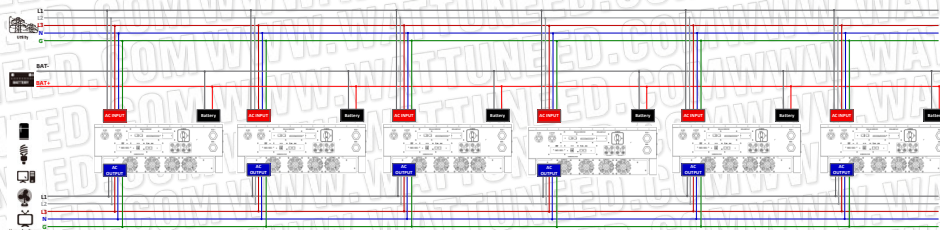

Communication Connection



## Setting and LCD Display

### Setting Program:

The parallel function setting is only available by SolarPower. Please install SolarPower in your PC first.

For setting, you can set the inverter one by one through RS232 or USB port.

But we suggest to use SNMP or Modbus card to combine the system as a centralized monitoring system. Then, you can use "SYNC" function to set all the inverters at the same time. If using SNMP or Modbus card to set up program, the bundled software is SolarPower Pro.

- Use SNMP card to synchronize the parameters:

Each inverter should be installed one SNMP card. Make sure all of the SNMP cards are connected to the router as a LAN.

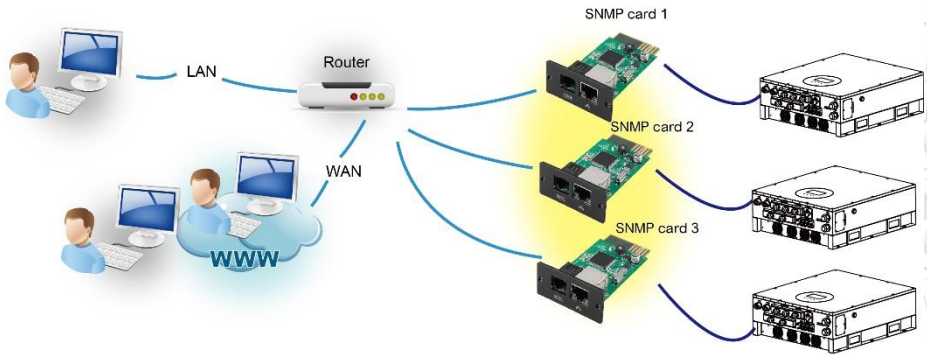

- Use Modbus card to synchronize the parameters:

Each inverter should be installed one Modbus card. Make sure all of the Modbus cards are connected to each other and one of the Modbus cards is connected to the computer by RS-485/RS232 converter.

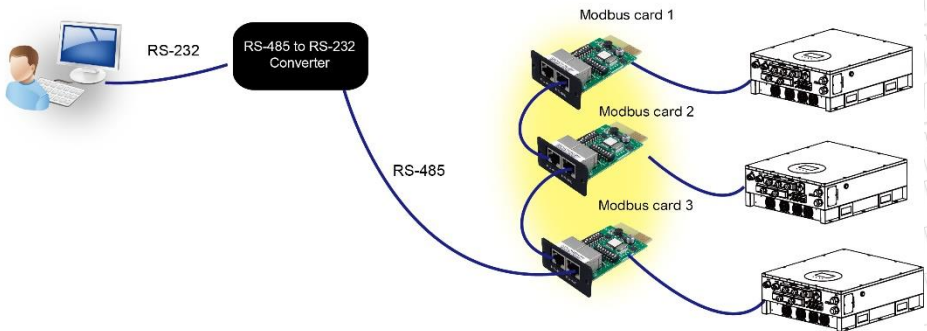

Launch SolarPowerPro in computer and select Device Control >> Parameter Setting >> Parallel output. Two options: Enable or Disable.

If you want to use parallel function, please choose "Enable" and press "Apply" button.

Then, "Sync" button will be shown is the screen. Please be sure to click

 button before clicking  button.

There is a "Sync" button in each parameter setting. When "Sync" is clicked and "Apply" is pressed, this new setting will be applied to all inverters. If not, this setting is only effected in current inverter you choose.

Note: Without centralized monitoring system, "Sync" function is not effective. Then, you have to set up the inverter one by one through serial communication port.

### Parallel for output: Enable

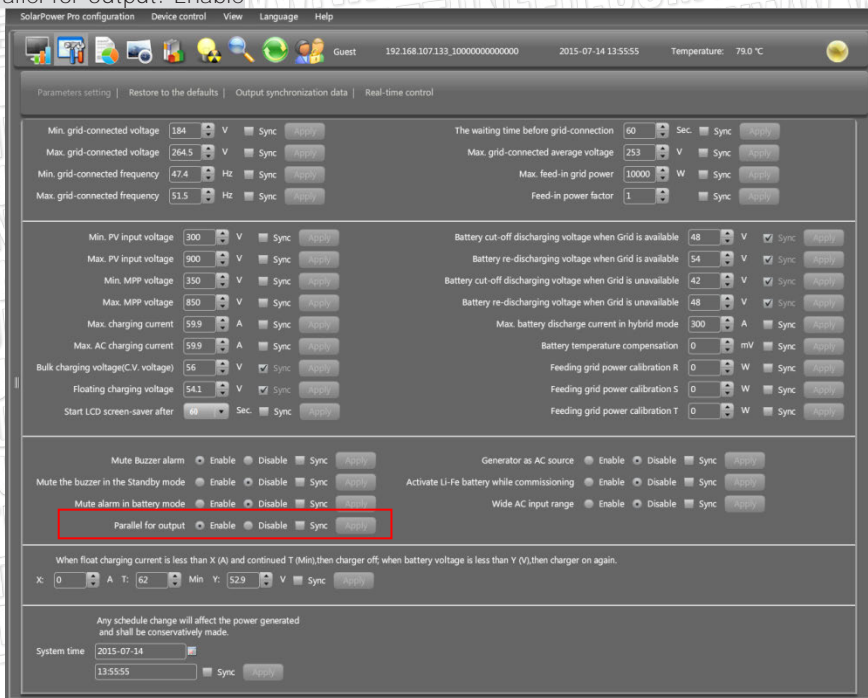

SolarPower Pro configuration Device control View Language Help

Guest 192.168.107.133\_1000000000000 2015-07-14 13:55:55 Temperature: 79.0 °C

Parameters setting | Restore to the defaults | Output synchronization data | Real-time control

Min. grid-connected voltage: 184 V	Sync	Apply	The waiting time before grid-connection: 60 Sec.	Sync	Apply
Max. grid-connected voltage: 264.5 V	Sync	Apply	Max. grid-connected average voltage: 253 V	Sync	Apply
Min. grid-connected frequency: 47.4 Hz	Sync	Apply	Max. feed-in grid power: 10000 W	Sync	Apply
Max. grid-connected frequency: 51.5 Hz	Sync	Apply	Feed-in power factor: 1	Sync	Apply

Min. PV input voltage: 300 V	Sync	Apply	Battery cut-off discharging voltage when Grid is available: 48 V	Sync	Apply
Max. PV input voltage: 900 V	Sync	Apply	Battery re-discharging voltage when Grid is available: 54 V	Sync	Apply
Min. MPP voltage: 350 V	Sync	Apply	Battery cut-off discharging voltage when Grid is unavailable: 42 V	Sync	Apply
Max. MPP voltage: 850 V	Sync	Apply	Battery re-discharging voltage when Grid is unavailable: 48 V	Sync	Apply
Max. charging current: 59.9 A	Sync	Apply	Max. battery discharge current in hybrid mode: 300 A	Sync	Apply
Max. AC charging current: 59.9 A	Sync	Apply	Battery temperature compensation: 0 mV	Sync	Apply
Bulk charging voltage(C.V. voltage): 56 V	Sync	Apply	Feeding grid power calibration R: 0 W	Sync	Apply
Floating charging voltage: 54.1 V	Sync	Apply	Feeding grid power calibration S: 0 W	Sync	Apply
Start LCD screen-saver after: 60 Sec.	Sync	Apply	Feeding grid power calibration T: 0 W	Sync	Apply

Mute Buzzer alarm: Enable	Disable	Sync	Generator as AC source: Enable	Disable	Sync
Mute the buzzer in the Standby mode: Enable	Disable	Sync	Activate Li-Fe battery while commissioning: Enable	Disable	Sync
<b>Mute alarm in battery mode: Enable</b>	<b>Disable</b>	<b>Sync</b>	Wide AC input range: Enable	Disable	Sync
Parallel for output: Enable	Disable	Sync			

When float charging current is less than X (A) and continued T (Min),then charger off; when battery voltage is less than Y (V),then charger on again.

X: 0 A T: 62 Min Y: 52.9 V

Any schedule change will affect the power generated and shall be conservatively made.

System time: 2015-07-14 13:55:55



## Parallel for output: Disable

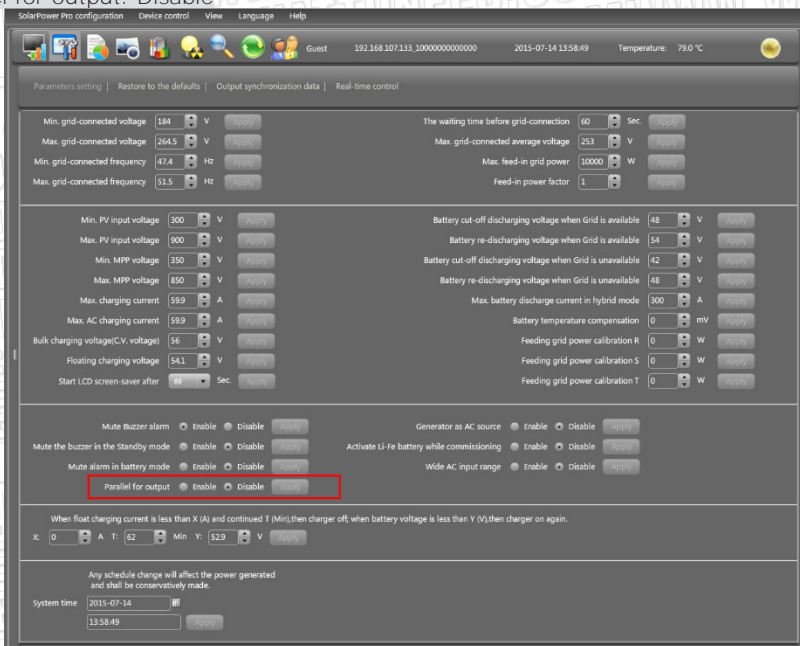

## Fault code display:

Fault Code	Fault Event	Icon on
60	Power feedback protection	F60 FAULT
71	Firmware version inconsistent	F71 FAULT
72	Current sharing fault	F72 FAULT
80	CAN fault	F80 FAULT
81	Host loss	F81 FAULT
82	Synchronization loss	F82 FAULT

## Commissioning

Step 1: Check the following requirements before commissioning:

- Correct wire connection.
- Ensure all breakers in Line wires of load side are open and each Neutral wire of each unit is connected together.

Step 2: Turn on each unit and set "enable parallel for output" on SolarPower or SolarPower Pro. And then, shut down all units.

Step 3: Turn on each unit.

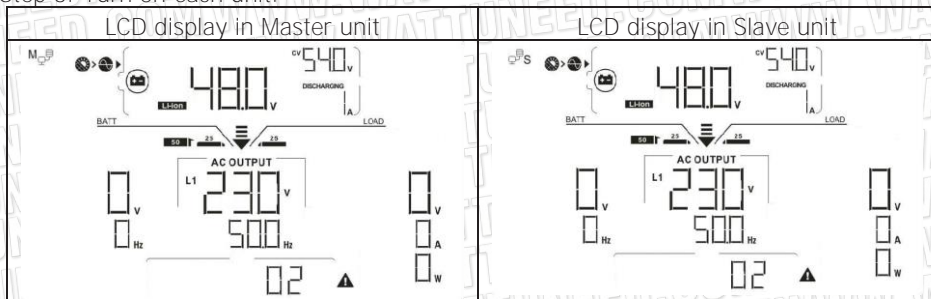

NOTE: Master and slave units are randomly defined. Warning 02 is AC GRID voltage low.

Step 4: Switch on all AC breakers of Line wires in AC input. It's better to have all inverters connect to utility at the same time. If not, it will display fault 82 in following-order inverters. However, these inverters will automatically restart. If detecting AC connection, they will work normally.

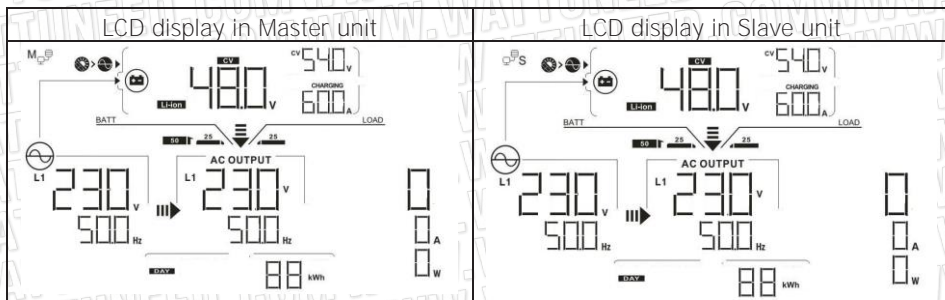

Step 5: If there is no more fault alarm, the parallel system is completely installed.

Step 6: Please switch on all breakers of Line wires in load side. This system will start to provide power to the load.

## Trouble shooting

Situation		Solution
Fault Code	Fault Event Description	
37	Over current on Neutral wire	<ol style="list-style-type: none"> <li>1. Remove excessive loads.</li> <li>2. Restart the inverter.</li> <li>3. If the problem remains, please contact your installer.</li> </ol>
60	Current feedback into the inverter is detected.	<ol style="list-style-type: none"> <li>4. Restart the inverter.</li> <li>5. Check if L1/L2/L3/N cables are not connected with wrong sequence in all inverters.</li> <li>6. Make sure the sharing cables are connected in all inverters.</li> <li>7. If the problem remains, please contact your installer.</li> </ol>
61	Relay board driver loss,	<ol style="list-style-type: none"> <li>1. Disconnect all of power source.</li> <li>2. Only connect AC input and press Enter key to let it working in bypass mode.</li> </ol>
62	Relay board communication loss,	<ol style="list-style-type: none"> <li>3. Check if the problem happens again or not and feed back the result to your installer.</li> </ol>
71	The firmware version of each inverter is not the same.	<ol style="list-style-type: none"> <li>1. Update all inverter firmware to the same version.</li> <li>2. After updating, if the problem still remains, please contact your installer.</li> </ol>
72	The output current of each inverter is different.	<ol style="list-style-type: none"> <li>1. Check if sharing cables are connected well and restart the inverter.</li> <li>2. If the problem remains, please contact your installer.</li> </ol>
80	CAN data loss	<ol style="list-style-type: none"> <li>1. Check if communication cables are connected well and restart the inverter.</li> <li>2. If the problem remains, please contact your installer.</li> </ol>
81	Host data loss	
82	Synchronization data loss	

## Appendix II: BMS

### 1. BMS port pin define:

	Definition
PIN 3	RS485B
PIN 5	RS485A
PIN 8	GND

### 2. After all wires are connected well and the communication between the inverter and battery is successful, it will show successful icon on the LCD screen.

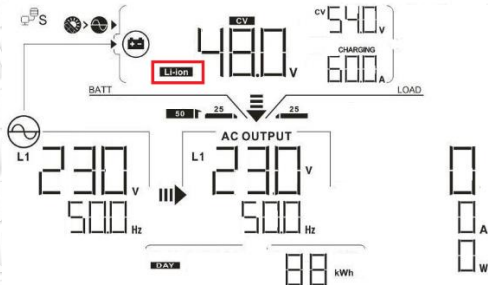

### 3. Code Reference

Related information code will be displayed on LCD screen. Please check inverter LCD screen for the operation.

Code	Description
b0	Informs inverter to stop discharging battery.
b1	Informs inverter to stop charging battery
b2	Informs inverter to charge battery.

# Appendix III : Wi-Fi Operation Guide

## 1. Introduction

Wi-Fi module can enable wireless communication between off-grid inverters and monitoring platform. Users have complete and remote monitoring and controlling experience for inverters when combining Wi-Fi module with SolarPower APP, available for both iOS and Android based device. All data loggers and parameters are saved in iCloud. The major functions of this APP:

- Delivers device status during normal operation.
- Allows to configure device setting after installation.
- Notifies users when a warning or alarm occurs.
- Allows users to query inverter history data.

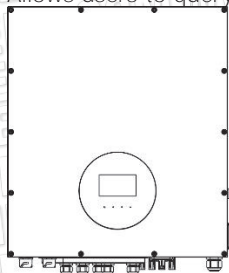

## 2. SolarPower App

### 2-1. Download and install APP

*Operating system requirement for your smart phone:*

🍏 iOS system supports iOS 9.0 and above

🤖 Android system supports Android 5.0 and above

Please scan the following QR code with your smart phone and download SolarPower App.



Android  
system



iOS system

Or you may find "SolarPower" app from the Apple® Store or "SolarPower Wi-Fi" in Google® Play Store.



## 2-2. Initial Setup

### Step 1: Registration at first time

After the installation, please tap the shortcut icon  to access this APP on your mobile screen. In the screen, tap "Register" to access "User Registration" page. Fill in all required information and scan the remote box PN by tapping  icon. Or you can simply enter PN directly. Then, tap "Register" button.



Please enter user name

Please enter the password

Remember Me

Login

Wi-Fi Config

Do not have an account? Please [Register](#)

Then, a "Registration success" window will pop up. Tap "Go now" to continue setting local Wi-Fi network connection.

#### Registration success

Is the Wi-Fi network configured for this device (PN:Q0819410124000) immediately?

[Log in](#)

[Go now](#)

### Step 2: Local Wi-Fi Module Configuration

Now, you are in "Wi-Fi Config" page. There are detailed setup procedure listed in "How to connect?" section and you may follow it to connect Wi-Fi.



1 Connect The Wi-Fi Module  
2 Network Settings  
3 Confirm The Wi-Fi Module Configuration  
4 Successful

Please connect to the same Wi-Fi as the Wi-Fi Module PN for configuration.



#### How to connect?

1. Enter the iPhone system 'Settings-Wi-Fi';
2. Select the same Wi-Fi as the Wi-Fi Module PN to connect;
3. After the connection is successful, return to the APP for network configuration.

Confirm Connected Wi-Fi Module

#### How to connect?

1. Enter the iPhone system 'Settings-Wi-Fi';
2. Select the same Wi-Fi as the Wi-Fi Module PN to connect;
3. After the connection is successful, return to the APP for network configuration.

Confirm Connected Wi-Fi Module

Enter the "Settings→Wi-Fi" and select connected Wi-Fi name. The connected Wi-Fi name is the same to your Wi-Fi PN number and enter default password "12345678".



Enter the password for "Q0819310000181"

Cancel

Enter Password

Join

Default password

Password 12345678

Confirm Connected Wi-Fi Module

Then, return to SolarPower APP and tap "Confirm Connected Wi-Fi Module" button when Wi-Fi module is connected successfully.

Step 3: Wi-Fi Network settings

Tap  icon to select your local Wi-Fi router name (to access the internet) and enter password.

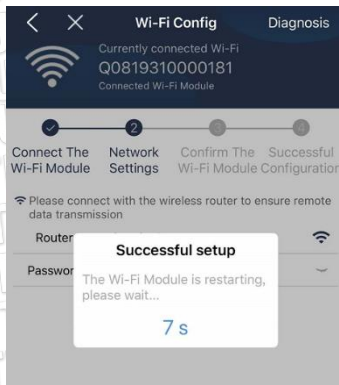
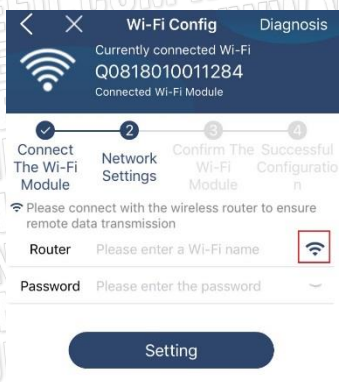

Step 4: Tap "Confirm" to complete the Wi-Fi configuration between the Wi-Fi module and the Internet.

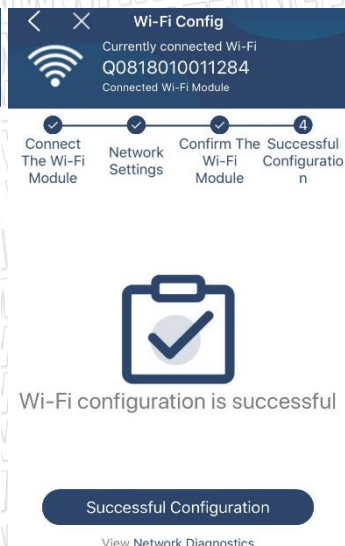
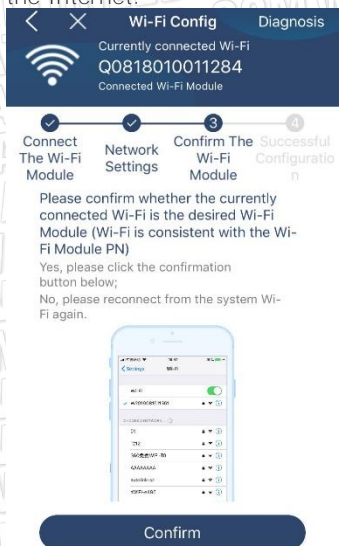



If the connection fails, please repeat Step 2 and 3.



Connect The Wi-Fi Module   Network Settings   **3 Confirm The Wi-Fi Module**   4 Successful Configuration

Please confirm whether the currently connected Wi-Fi is the desired Wi-Fi Module (Wi-Fi is consistent with the Wi-Fi Module).

Your phone is not currently connected to the datalogger Wi-Fi, please connect and try again!



Confirm



Please confirm whether the currently connected Wi-Fi is the desired Wi-Fi Module (Wi-Fi is consistent with the Wi-Fi Module).

Your phone is not currently connected to the datalogger Wi-Fi, please connect and try again!

### Diagnose Function

If the module is not monitoring properly, please tap "Diagnosis" on the top right corner of the screen for further details. It will show repair suggestion. Please follow it to fix the problem. Then, repeat the steps in the chapter 4.2 to re-set network setting. After all setting, tap "Rediagnosis" to re-connect again.



Repair suggestion

Rediagnosis

#### The Inverter and the datalogger communicate abnormally.

- Please check if the Inverter and the datalogger are powered on normally.
- Please check if the Inverter address is between 1 and 5.
- Please check if the connection between the Inverter and the collector is abnormal, such as poor contact caused by oxidation or looseness of the interface, reverse connection of the 485 interface AB line, and data line damage.
- Try restarting the Inverter and datalogger to see if the anomaly is eliminated.

#### Datalogger and router communication abnormalities

- Please confirm that the wireless routing network setting has been made.
- Make sure that the datalogger is set up to connect to AP hotspots sent by hardware devices such as wireless routers instead of virtual AP hotspots.



Repair suggestion

Rediagnosis

The diagnosis is successful!

### 2-3. Login and APP Main Function

After finishing the registration and local Wi-Fi configuration, enter registered name and password to login.

Note: Tick "Remember Me" for your login convenience afterwards.

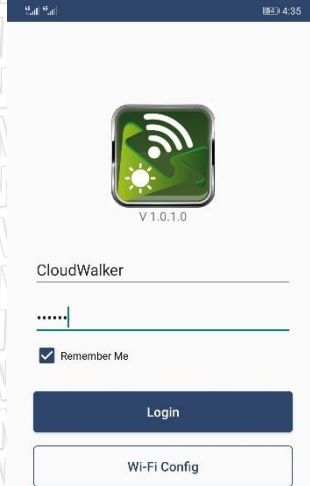

#### Overview

After login is successfully, you can access "Overview" page to have overview of your monitoring devices, including overall operation situation and Energy information for Current power and Today power as below diagram.



## Devices

Tap the  icon (located on the bottom) to enter Device List page. You can review all devices here by adding or deleting Wi-Fi Module in this page.

### Add device

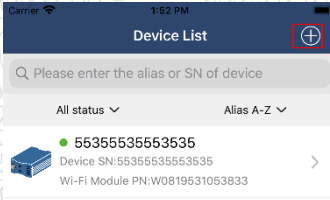

### Delete device

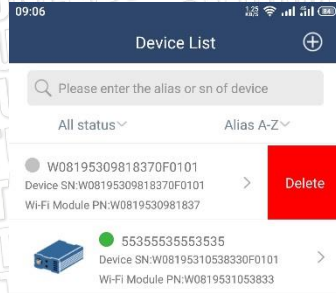

Tap  icon on the top right corner and manually enter part number to add device. This part number label is pasted on the bottom of inverter. After entering part number, tap "Confirm" to add this device in the Device list.

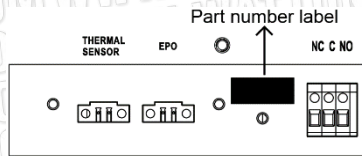
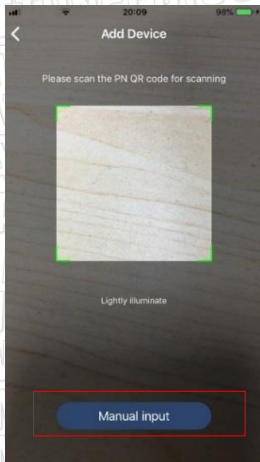

Part number label is pasted on the bottom of inverter.

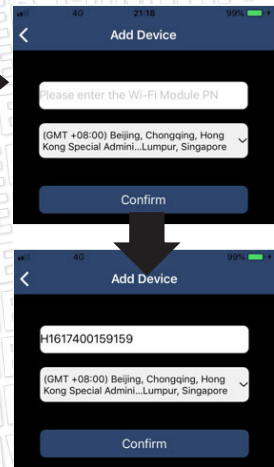

For more information about Device List, please refer to the section 2.4.

## ME

In ME page, users can modify "My information", including **【User's Photo】**, **【Account security】**, **【Modify password】**, **【Clear cache】**, and **【Log-out】**, shown as below diagrams.

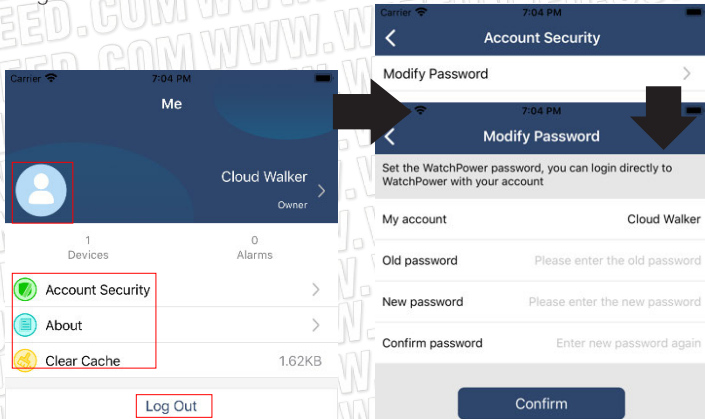

## 2-4. Device List

In Device List page, you can pull down to refresh the device information and then tap any device you want to check up for its real-time status and related information as well as to change parameter setting. Please refer to the parameter setting list.

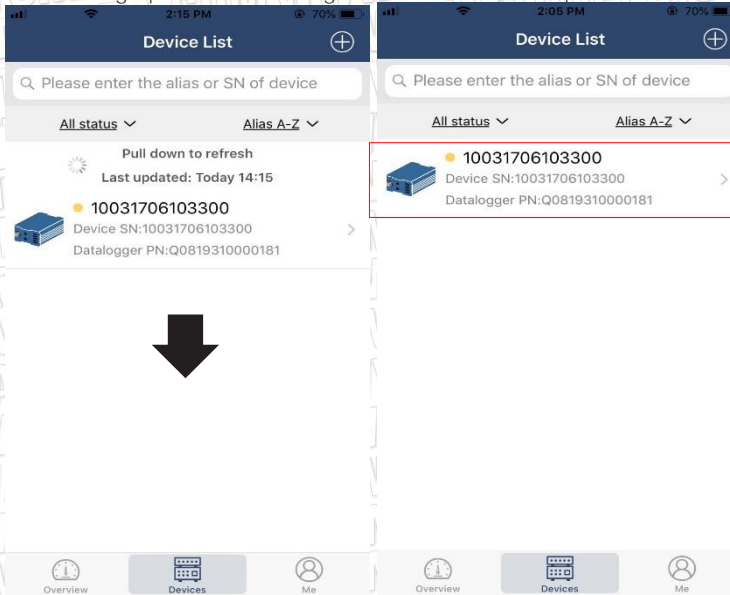



Basic Information	product Info
Grid Voltage	0.0V
Grid Frequency	0.0Hz
PV Input Voltage	0.0V
Battery Voltage	26.2V
Battery Capacity	100%
Battery Charging Current	0A
Battery Discharge Current	0A
AC Output Voltage	229.5V
AC Output Frequency	60.0Hz

### Device Mode

On the top of screen, there is a dynamic power flow chart to show live operation. It contains five icons to present PV power, inverter, load, utility and battery. Based on your inverter model status, there will be **【Standby Mode】**, **【Line Mode】**, **【Battery Mode】**.

**【Standby Mode】** Inverter will not power the load until “ON” switch is pressed. Qualified utility or PV source can charge battery in standby mode.



**【Line Mode】** Inverter will power the load from the utility with or without PV charging. Qualified utility or PV source can charge battery.



**【Battery Mode】** Inverter will power the load from the batter with or without PV charging. Only PV source can charge battery.



### Device Alarm and Name Modification

In this page, tap the  icon on the top right corner to enter the device alarm page.

Then, you can review alarm history and detailed information. Tap the  icon on the top right corner, a blank input box will pop out. Then, you can edit the name for your device and tap "Confirm" to complete name modification.

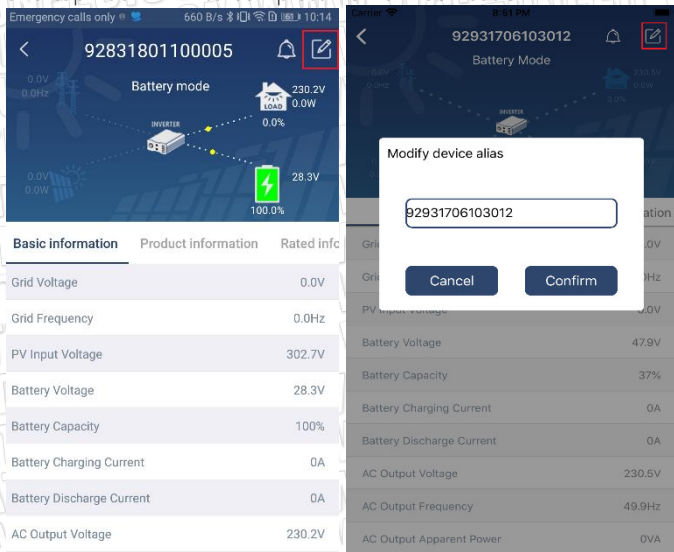

### Device Information Data

Users can check up **【Basic Information】**, **【Product Information】**, **【Rated information】**, **【History】**, and **【Wi-Fi Module Information】** by swiping left.



Basic Information		product Info
Grid Voltage	Swipe left	0.0V
Grid Frequency	←	0.0Hz
PV Input Voltage		0.0V
Battery Voltage		26.2V
Battery Capacity		100%
Battery Charging Current		0A
Battery Discharge Current		0A
AC Output Voltage		229.5V
AC Output Frequency		60.0Hz

【Basic Information】 displays basic information of the inverter, including AC voltage, AC frequency, PV input voltage, Battery voltage, Battery capacity, Charging current, Output voltage, Output frequency, Output apparent power, Output active power and Load percent. Please slide up to see more basic information.

【Production Information】 displays Model type (Inverter type), Main CPU version, Bluetooth CPU version and secondary CPU version.

【Rated Information】 displays information of Nominal AC voltage, Nominal AC current, Rated battery voltage, Nominal output voltage, Nominal output frequency, Nominal output current, Nominal output apparent power and Nominal output active power. Please slide up to see more rated information.

【History】 displays the record of unit information and setting timely.

【Wi-Fi Module Information】 displays of Wi-Fi Module PN, status and firmware version.

### Parameter Setting

This page is to activate some features and set up parameters for inverters. Please be noted that the listing in "Parameter Setting" page in below diagram may differ from the models of monitored inverter. Here will briefly highlight some of it, 【Output Setting】 ,

【Battery Parameter Setting】 , 【Enable/ Disable items】 , 【Other Settings】 , 【Restore to the defaults】 to illustrate.

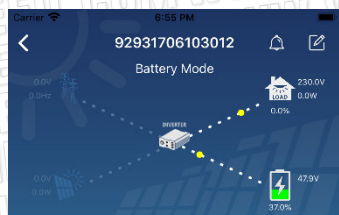

Parameter Setting	Wi-Fi Mod
Output Setting	>
Battery Parameter Setting	>
Enable/Disable Items	>
Restore to the defaults	>
Time zone setting	>
Wi-Fi Module configuration	>

There are three ways to modify setting and they vary according to each parameter.

- Listing options to change values by tapping one of it.
- Activate/Shut down functions by clicking "Enable" or "Disable" button.
- Changing values by clicking arrows or entering the numbers directly in the column.

Each function setting is saved by clicking "Set" button.

Please refer to below parameter setting list for an overall description and be noted that the available parameters may vary depending on different models. Please always see the original product manual for detailed setting instructions.

Parameter setting list:

Item		Description
Output setting	Output source priority	To configure load power source priority.
	AC input range	Input voltage range selection
	Output voltage	To set output voltage.
	Output frequency	To set output frequency.
Battery parameter setting	Battery Type	Select connected battery type
	Battery Cut-off Voltage	Set battery cut-off voltage



	Bulk Charging Voltage	Set battery bulk charging voltage
	Battery Float Voltage	Set battery floating charging voltage
	Max Charging Current	To configure total charging current for solar and utility chargers.
	Max AC Charging Current	Set maximum utility charging current
	Charging Source Priority	To configure charger source priority
	Back To Grid Voltage	Set battery voltage to stop discharging when grid is available
	Back To Discharge Voltage	Set battery voltage to stop charging when grid is available
Enable/Disable Functions	Overload Auto Restart	If disabled, the unit won't be restarted after overload occurs.
	Overload Temperature Auto Restart	If disabled, the unit won't be restarted after over-temperature fault is solved.
	Overload Bypass	If enabled, the unit will enter bypass mode when overload occurs.
	Beeps While Primary Source Interrupt	If enabled, buzzer will alarm when primary source is abnormal.
	Buzzer	If disabled, buzzer won't be on when alarm/fault occurred.
	Backlight	If disabled, LCD backlight will be off when panel button is not operated for 1 minute.

	LCD Screen Return To Default Display	If selected, no matter how users switch display screen, it will automatically return to default display screen (Input voltage /output voltage) after no button is pressed for 1 minute.
	Fault Code Record	If enabled, fault code will be recorded in the inverter when any fault happens.
	Solar Feed To Grid	If selected, solar energy is allowed to feed to the grid.
Other Settings	Solar Supply Priority	Set solar power as priority to charge the battery or to power the load.
	Reset PV Energy Storage	If clicked, PV energy storage data will be reset.
	Start Time For Enable AC Charge Working	The setting range of start charging time for AC charger is from 00:00 to 23:00. The increment of each click is 1 hour.
	Ending Time For Enable AC Charge Working	The setting range of stop charging time for AC charger is from 00:00 to 23:00. The increment of each click is 1 hour.
	Scheduled Time For AC Output On	The setting range of scheduled time for AC output on is from 00:00 to 23:00. The increment of each click is 1 hour.
	Scheduled Time For AC Output Off	The setting range of scheduled time for AC output off is from 00:00 to 23:00. The increment of each click is 1 hour.
	Country Customized Regulations	Select inverter installed area to meet local regulation.
	Set Date Time	Set date time.
Restore to the default	This function is to restore all settings back to default settings.	