

3-Phase PV Grid-Connected Inverter

User Manual

**SG3.0RT / SG4.0RT / SG5.0RT / SG6.0RT /
SG7.0RT / SG8.0RT / SG10RT / SG12RT /
SG15RT / SG17RT / SG20RT**



All Rights Reserved

All Rights Reserved

No part of this document can be reproduced in any form or by any means without the prior written permission of Sungrow Power Supply Co., Ltd (hereinafter "SUNGROW").

Trademarks

SUNGROW and other Sungrow trademarks used in this manual are owned by Sungrow Power Supply Co., Ltd.

All other trademarks or registered trademarks mentioned in this document are owned by their respective owners.

Software Licenses

- It is prohibited to use data contained in firmware or software developed by SUNGROW, in part or in full, for commercial purposes by any means.
- It is prohibited to perform reverse engineering, cracking, or any other operations that compromise the original program design of the software developed by SUNGROW.

Sungrow Power Supply Co., Ltd.

Address: **No.1699 Xiyou Rd., New & High Tech Zone, Hefei, 230088, China.**

Tel: +86 551 6532 7834

Website: www.sungrowpower.com

About This Manual

The manual mainly contains the product information, as well as guidelines for installation, operation and maintenance. The manual does not include complete information about the photovoltaic (PV) system. The reader can get additional information about other devices at www.sungrowpower.com or on the webpage of the respective component manufacturer.

Validity

This manual is valid for the following inverter models:

- SG3.0RT
- SG4.0RT
- SG5.0RT
- SG6.0RT
- SG7.0RT
- SG8.0RT
- SG10RT
- SG12RT
- SG15RT
- SG17RT
- SG20RT

They will be referred to as "inverter" hereinafter unless otherwise specified.

Target Group

This manual is intended for inverter owners who will have the ability to interact with the inverter and qualified personnel who are responsible for the installation and commissioning of the inverter. Qualified personnel should have the following skills:

- Training for installation and commissioning of electrical system, as well as dealing with hazards
- Knowledge of the manual and other related documents
- Knowledge of the local regulations and directives

How to Use This Manual

Read the manual and other related documents before performing any work on the inverter. Documents must be stored carefully and be available at all times.

Contents may be periodically updated or revised due to the product development. It is probably that there are changes of manual in the subsequent inverter edition. The latest manual can be found at support.sungrowpower.com.

Symbols

Important instructions contained in this manual should be followed during installation, operation and maintenance of the inverter. They will be highlighted by the following symbols.

DANGER

Indicates a hazard with a high level of risk that, if not avoided, will result in death or serious injury.

WARNING

Indicates a hazard with a medium level of risk that, if not avoided, could result in death or serious injury.

CAUTION

Indicates a hazard with a low level of risk that, if not avoided, could result in minor or moderate injury.

NOTICE

Indicates a situation that, if not avoided, could result in equipment or property damage.



Indicates additional information, emphasized contents or tips that may be helpful, e.g. to help you solve problems or save time.

Contents

All Rights Reserved	I
About This Manual	II
1 Safety	1
1.1 PV Panels	1
1.2 Utility Grid	1
1.3 Inverter	2
2 Product Description	4
2.1 System Introduction	4
2.2 Product Introduction	5
2.3 Symbols on the Product	7
2.4 LED Indicator	8
2.5 Circuit Diagram	8
2.6 Function Description	9
3 Unpacking and Storage	12
3.1 Unpacking and Inspection	12
3.2 Inverter Storage	12
4 Mechanical Mounting	13
4.1 Safety during Mounting	13
4.2 Location Requirements	13
4.2.1 Environment Requirements	13
4.2.2 Carrier Requirements	14
4.2.3 Angle Requirements	14
4.2.4 Clearance Requirements	15
4.3 Installation Tools	16
4.4 Moving the Inverter	17
4.5 Installing the Inverter	17
5 Electrical Connection	20
5.1 Safety Instructions	20
5.2 Terminal Description	20
5.3 Electrical Connection Overview	22
5.4 Additional Grounding Connection	23

5.4.1 Additional Grounding Requirements.....	24
5.4.2 Connection Procedure.....	24
5.5 AC Cable Connection.....	25
5.5.1 AC Side Requirements.....	25
5.5.2 Assembling the AC Connector (< 15 kW).....	26
5.5.3 Installing the AC Connector (< 15 kW).....	28
5.5.4 Assembling the AC Connector (\geq 15 kW).....	29
5.5.5 Installing the AC Connector (\geq 15 kW).....	31
5.6 DC Cable Connection.....	33
5.6.1 PV Input Configuration.....	34
5.6.2 Assembling the PV Connectors.....	35
5.6.3 Installing the PV Connectors.....	36
5.7 WiNet-S Connection.....	38
5.7.1 Ethernet Communication.....	38
5.7.2 WLAN Communication.....	40
5.8 Meter Connection.....	40
5.8.1 Assembling the COM Connector.....	41
5.8.2 Installing the COM Connector.....	43
5.9 RS485 Connection.....	44
5.9.1 RS485 Communication System.....	44
5.9.2 Assembling the COM Connector.....	44
5.9.3 Installing the COM Connector.....	47
5.10 DO Connection.....	48
5.11 DRM Connection.....	49
6 Commissioning.....	51
6.1 Inspection before Commissioning.....	51
6.2 Powering on the System.....	51
6.3 App Preparation.....	51
6.4 Creating a Plant.....	52
6.5 Initializing the Device.....	54
6.6 Configuring the Plant.....	57
7 iSolarCloud App.....	61
7.1 Brief Introduction.....	61
7.2 Installing the App.....	61
7.3 Account Registration.....	62
7.4 Login.....	63

7.4.1 Requirements	63
7.4.2 Login Procedure	63
7.5 Initial Settings	65
7.6 Function Overview	65
7.7 Home.....	66
7.8 Run Information	67
7.9 Records	68
7.10 More.....	71
7.10.1 System Parameters	71
7.10.2 Operation Parameters	72
7.10.3 Power Regulation Parameters.....	73
7.10.4 Communication Parameters	78
7.10.5 Firmware Update.....	78
8 System Decommissioning	80
8.1 Disconnecting the Inverter.....	80
8.2 Dismantling the Inverter.....	81
8.3 Disposal of the Inverter.....	81
9 Troubleshooting and Maintenance	82
9.1 Troubleshooting	82
9.2 Maintenance.....	86
9.2.1 Maintenance Notices.....	86
9.2.2 Routine Maintenance.....	87
9.2.3 Fan Maintenance	87
10 Appendix	90
10.1 Technical Data	90
10.2 Quality Assurance	100
10.3 Contact Information	101

1 Safety

The device has been designed and tested strictly according to international safety regulations. Read all safety instructions carefully prior to any work and observe them at all times when working on or with the device.

Incorrect operation or work may cause:

- Injury or death to the operator or a third party;
- Damage to the device and other properties.

All detailed work-related safety warnings and notes will be specified at critical points in this manual.



The safety instructions in this manual cannot cover all the precautions that should be followed. Perform operations considering actual onsite conditions. SUNGROW shall not be held liable for any damage caused by violation of the safety instructions in this manual.

1.1 PV Panels

DANGER

PV strings will produce electrical power when exposed to sunlight and can cause a lethal voltage and an electric shock.

- Always keep in mind that the inverter is dual power supplied. Electrical operators must wear proper personal protective equipment: helmet, insulated footwear, gloves, etc.
- Before touching the DC cables, operator must use a measuring device to ensure that the cable is voltage-free.
- Follow all warnings on the PV strings and in its manual.

1.2 Utility Grid

Follow the regulations related to the utility grid.

NOTICE

All electrical connections must be in accordance with local and national standards.

Only with the permission of the local utility grid company, the inverter can be connected to the utility grid.

1.3 Inverter

⚠ DANGER

Danger to life from electric shocks due to live voltage

Do not open the enclosure at any time. Unauthorized opening will void warranty and warranty claims and in most cases terminate the operating license.

⚠ WARNING

Risk of inverter damage or personal injury

- Do not connect or disconnect the PV and AC connectors when the inverter is running.
- Wait at least 10 minutes for the internal capacitors to discharge after all electric devices are removed and the inverter is powered off.
- Ensure that there is no voltage or current before connecting or disconnecting the PV and AC connectors.

⚠ WARNING

All safety instructions, warning labels, and nameplate on the inverter:

- Must be clearly legible.
- Should not be removed or covered.

⚠ CAUTION

Risk of burns due to hot components!

Do not touch any hot parts (such as the heat sink) during operation. Only the DC switch can safely be touched at any time.

NOTICE

Only qualified personnel can perform the country setting. Unauthorized alteration may cause a breach of the type-certificate marking.

Risk of inverter damage due to electrostatic discharge (ESD)!

By touching the electronic components, you may damage the inverter. For inverter handling, be sure to:

- avoid any unnecessary touching;
- wear a grounding wristband before touching any connectors.

2 Product Description

2.1 System Introduction

The inverter is a transformerless 3-phase PV grid-connected inverter. As an integral component in the PV power system, the inverter is designed to convert the direct current power generated from the PV modules into grid-compatible AC current and feeds the AC current to the utility grid.

⚠ WARNING

- The inverter must only be operated with PV strings with class II protection in accordance with IEC 61730, application class A. It is not allowed for the positive pole or the negative pole of the PV strings to be grounded. This can cause damage to the inverter.
- Damages to the product due to a faulty or damaged PV installation are not covered by warranty.
- Any use other than the one described in this document is not permitted.

The intended usage of the inverter is illustrated in the following figure.

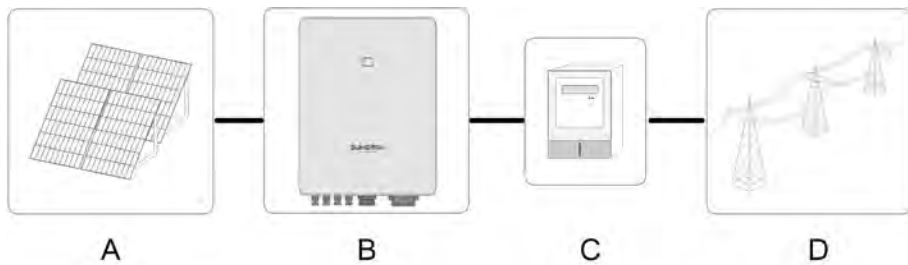
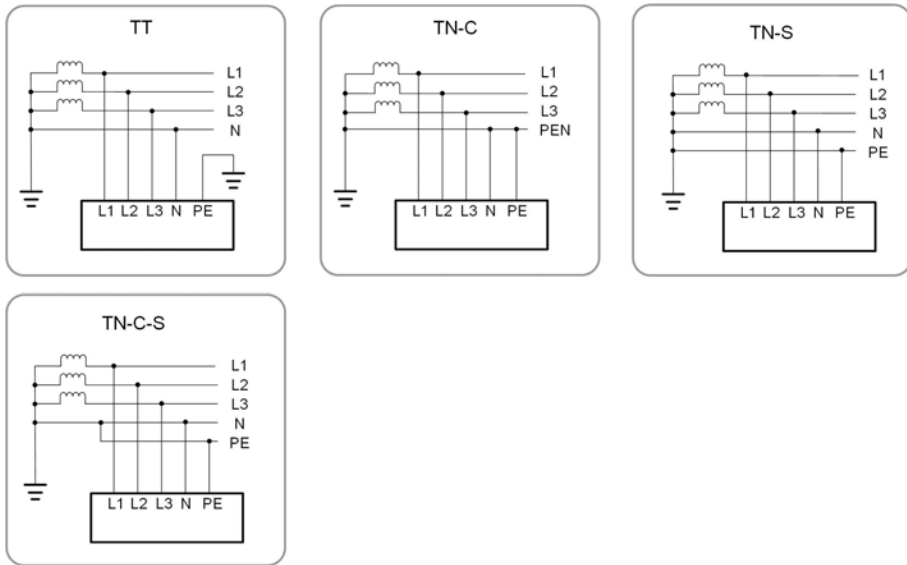

Figure 2-1 Inverter Application in PV Power System

Item	Description	Note
A	PV strings	Compatible with monocrystalline silicon, polycrystalline silicon, and thin-film modules without grounding
B	Inverter	SG3.0RT, SG4.0RT, SG5.0RT, SG6.0RT, SG7.0RT, SG8.0RT, SG10RT, SG12RT, SG15RT, SG17RT, SG20RT
C	Metering device	Meter cupboard with power distribution system
D	Utility grid	TT, TN-C, TN-S, TN-C-S

The following figure shows the common grid configurations.



2.2 Product Introduction

Model Description

The model description is as follows (take SG10RT as an example):

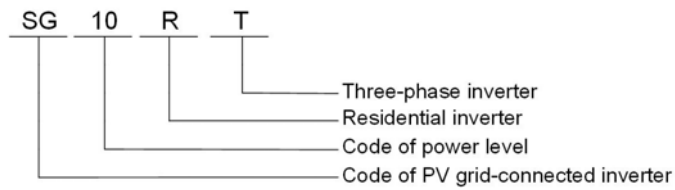

Appearance

The following figure shows the dimensions of the inverter. The image shown here is for reference only. The actual product received may differ.

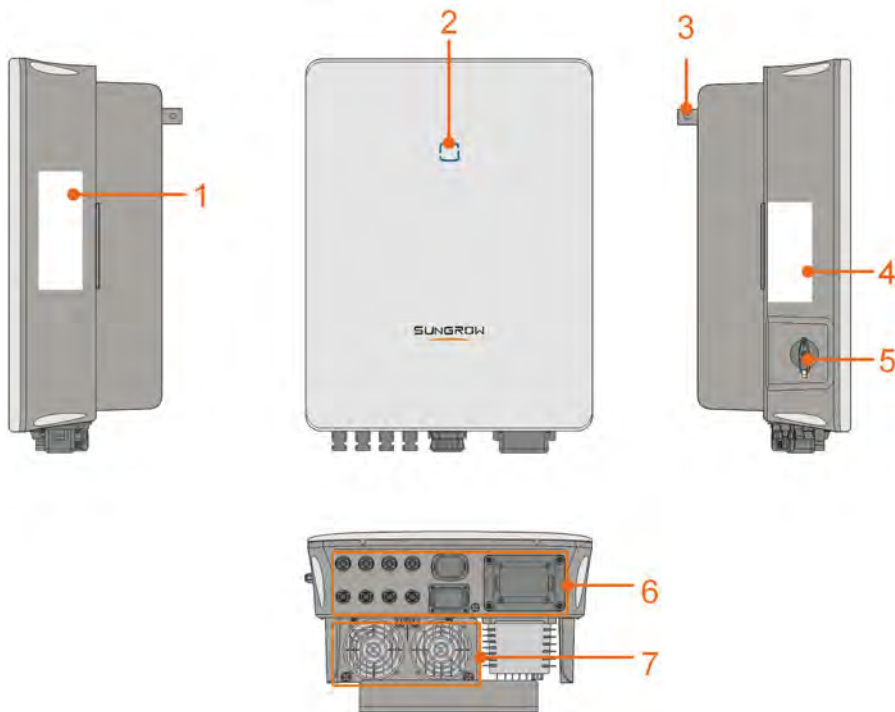

Figure 2-2 Inverter Appearance

No.	Name	Description
1	Nameplate	To clearly identify the product, including device model, S/ N, important specifications, marks of certification institutions, etc.
2	LED indicator	To indicate the current working state of the inverter.
3	Hanger	Complement to the included wall-mounting bracket for hanging the inverter.
4	Label	Information about COM2 pin definition, supported DRM modes, etc.
5	DC switch	To safely disconnect the DC circuit whenever necessary.
6	Electrical connection area	DC terminals (SG20RT for example), AC terminal, additional grounding terminal and communication terminals.
7	Fans	Optimization of the inverter ' s heat dissipation. Only the SG15RT, SG17RT and SG20RT are equipped with fans.

Dimensions

The following figure shows the dimensions of the inverter.

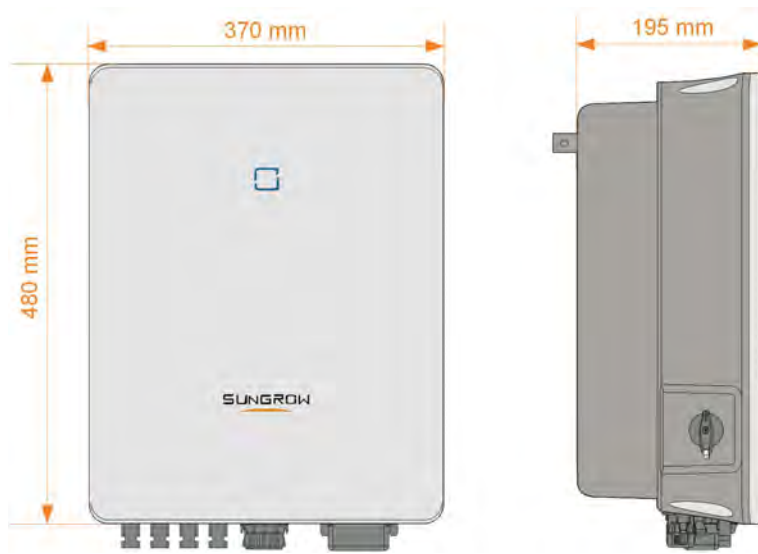











Figure 2-3 Dimensions of the Inverter(in mm)

2.3 Symbols on the Product





Symbol	Explanation
	Regulatory compliance mark.
	TÜV mark of conformity.
	CE mark of conformity.
	Do not dispose of the inverter together with household waste.
	The inverter does not have a transformer.
	Disconnect the inverter from all the external power sources before maintenance!
	Read the user manual before maintenance!
	Burn danger due to hot surface that may exceed 60°C.

Symbol	Explanation
	<p>Danger to life due to high voltages!</p> <p>Do not touch live parts for 10 minutes after disconnection from the power sources.</p> <p>Only qualified personnel can open and maintain the inverter.</p>
	<p>Additional grounding point.</p>

2.4 LED Indicator

The LED indicator on the front of the inverter indicates the working state of the inverter.

Table 2-1 State description of the LED indicator

LED color	State	Definition
 <p>Blue</p>	On	The inverter is operating normally.
 <p>Blue</p>	Flashing	The inverter is at standby or startup state (not feeding power into the grid).
 <p>Red</p>	On	A system fault has occurred.
 <p>Gray</p>	Off	Both the AC and DC sides are powered down.

2.5 Circuit Diagram

The following figure shows the main circuit of the inverter.

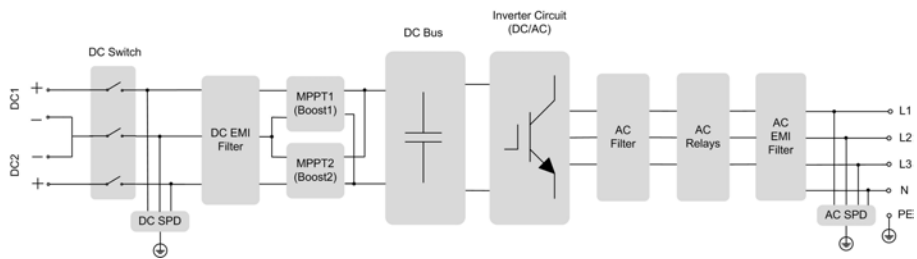

Figure 2-4 Circuit Diagram (SG5.0RT for example)

- The DC switch is used to safely disconnect the DC circuit.
- The MPPT is utilized for DC input to ensure the maximum power from the PV array at different PV input conditions.
- The inverter circuit converts the DC power into AC power and generates AC power to loads or utility grid through the AC terminal.
- The protection circuit ensures the safe operation of the device and personal safety.

2.6 Function Description

Basic Function

- Conversion function

The inverter converts the DC power from the PV array to the AC power, in conformity with the grid requirements.

- Data storage

The inverter logs running information, error records, etc.

- Parameter configuration

The inverter provides various parameter configurations for optimal operation. Parameters can be set via the iSolarCloud App or the cloud server. For further configurations, which exceeds the usual parameters configuration, please contact Sungrow.

- Communication interface

The inverter is equipped with two communication interfaces. The communication device can be connected to the inverter via both interfaces.

After communication connection is established, users can view inverter information, operational data and can set inverter parameters through the iSolarCloud.



It is recommended to use the communication module from SUNGROW. Using a device from other companies may lead to communication failure or other unexpected damage.

- Protection Function

Several protective functions are integrated in the inverter, including short circuit protection, grounding insulation resistance monitoring, residual current protection, grid monitoring, DC overvoltage/overcurrent protection, etc.

Fault Alarm

The inverter is equipped with a DO relay for the local fault alarm. The additional equipment required is a light indicator and/or a buzzer that needs additional power supply.

After the connection, if a fault occurs, the DO dry-contact will switch on automatically to signal the external alarm.

DRM ("AU"/"NZ")

The DRM function is only applicable to a single inverter.

The inverter provides terminals for connecting to a demand response enabling device (-DRED). After the connection, the DRED asserts demand response modes (DRMs). The inverter detects and initiates a response to all supported demand response modes listed in the following table.

Table 2-2 Demand Response Mode Explanation

Mode	Explanation
DRM0	The inverter is in the state of standby.

PID Recovery

- For positive voltage scheme, after the PID function is enabled, the voltage to ground of all PV strings is greater than 0, and therefore the PV string-to-ground voltage is a positive value.

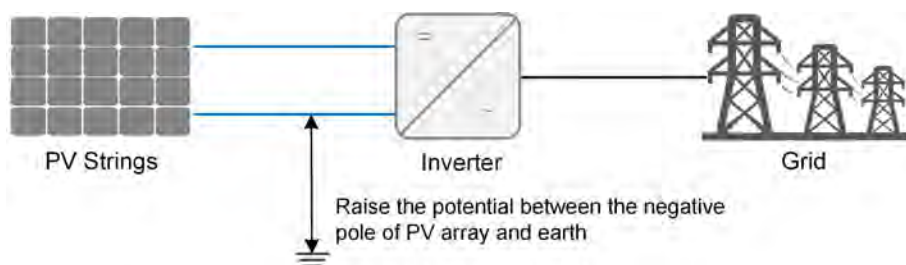

- For negative voltage scheme, after the PID function is enabled, the voltage to ground of all PV strings is lower than 0, and therefore the PV string-to-ground voltage is a negative value.

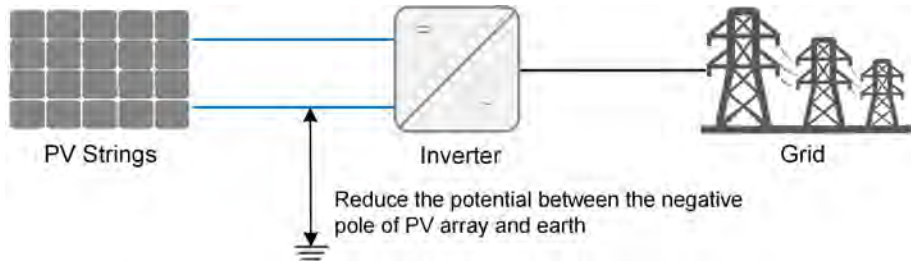

NOTICE

- Before enabling the PID recovery function, make sure the voltage polarity of the PV modules to ground meets requirement. If there are any questions, contact the PV module manufacturer or read its corresponding user manual.
- If the voltage scheme for the PID recovery function does not meet the requirement of corresponding PV modules, the PID function will not work as expected or even damage the PV modules.

When the inverter is not running, the PID module will apply inverse voltage to PV modules, to restore the degraded modules.



- If the PID recovery function is enabled, it only works at night.
- After the PID recovery function is enabled, the voltage of the PV strings to ground is 500 V DC by default, and the default value can be modified through the App.

3 Unpacking and Storage

3.1 Unpacking and Inspection

The device is thoroughly tested and strictly inspected before delivery. Nonetheless, damage may still occur during shipping. For this reason, please conduct a thorough inspection after receiving the device.

- Check the packing case for any visible damage.
- Check the scope of delivery for completeness according to the packing list.
- Check the inner contents for damage after unpacking.

Contact SUNGROW or the supplier in case of any damage or incompleteness.

Do not dispose of the original packing case. It is recommended to store the device in it.

3.2 Inverter Storage

Proper storage is required if the inverter is not installed immediately.

- Store the inverter in the original packing case with the desiccant inside.
- The storage temperature must be always between -30°C and $+70^{\circ}\text{C}$, and the storage relative humidity must be always between 0 and 95 %, non-condensing.
- In case of stacking storage, the number of stacking layers should never exceed the limit marked on the outer side of the packing case.
- The packing case should be upright.
- If the inverter has been stored more than half a year, the qualified personnel should thoroughly check and test it before installation.

4 Mechanical Mounting

4.1 Safety during Mounting

⚠ DANGER

Make sure there is no electrical connection before installation.
In order to avoid electric shock or other injury, make sure that holes will not be drilled over any electricity or plumbing installations.

⚠ CAUTION

Risk of injury due to improper handling

- Always follow the instructions when moving and positioning the inverter.
- Improper operation may cause injuries or serious wounds.

In the case of poor ventilation, the system performance may compromise.

- Keep the heat sinks uncovered to ensure heat dissipation performance.

4.2 Location Requirements

Select an optimal mounting location for safe operation, long service life and expected performance.

- The inverter with protection rating IP65 can be installed both indoors and outdoors.
- Install the inverter in a convenient place for electrical connection, operation and maintenance.

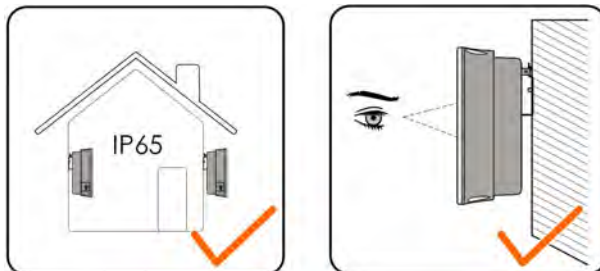

4.2.1 Environment Requirements

- The installation environment must be free of inflammable or explosive materials.
- The location should be not accessible to children.

- The ambient temperature and relative humidity must meet the following requirements.

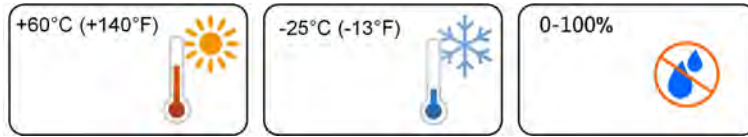

- Avoid direct exposure to sun, rain and snow.
- The inverter should be well ventilated. Ensure air circulation.
- Never install the inverter in living areas. The inverter will generate noise during operation, affecting daily life.

4.2.2 Carrier Requirements

The concrete wall should be capable of withstanding a force of four times the weight of the inverter and be suitable for the dimensions of the inverter.

The installation carrier should meet the following requirements:



4.2.3 Angle Requirements

Install the inverter vertically. Never install the inverter horizontally, or at forward/backward tilted, side tilted, or upside down.

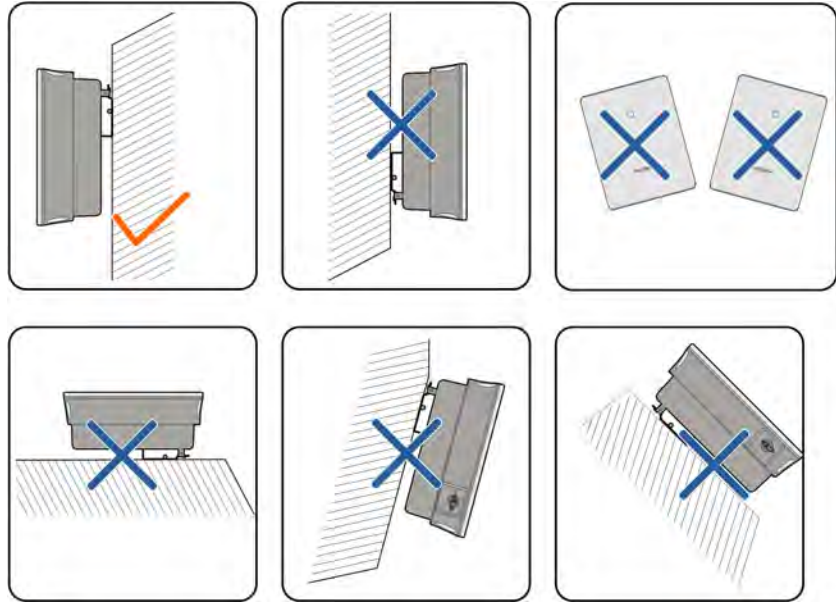

4.2.4 Clearance Requirements

Reserve enough clearance around the inverter to ensure sufficient space for heat dissipation.



In case of multiple inverters, reserve specific clearance between the inverters.



Install the inverter at an appropriate height for ease of viewing LED indicator and operating switch(es).

4.3 Installation Tools

Installation tools include but are not limited to the following recommended ones. If necessary, use other auxiliary tools on site.

Table 4-1 Tool specification

			
Goggles	Earplugs	Dust mask	Protective gloves
			
Insulated shoes	Utility knife	Marker	Wrist strap
			
Wire cutter	Wire stripper	Hydraulic plier	Rubber mallet
			
Hammer drill (φ10)	Phillips screwdriver (M3, M4, M6)	Electric screwdriver (M3, M4, M6)	Wrench (30 mm, 35 mm, 46 mm)
			

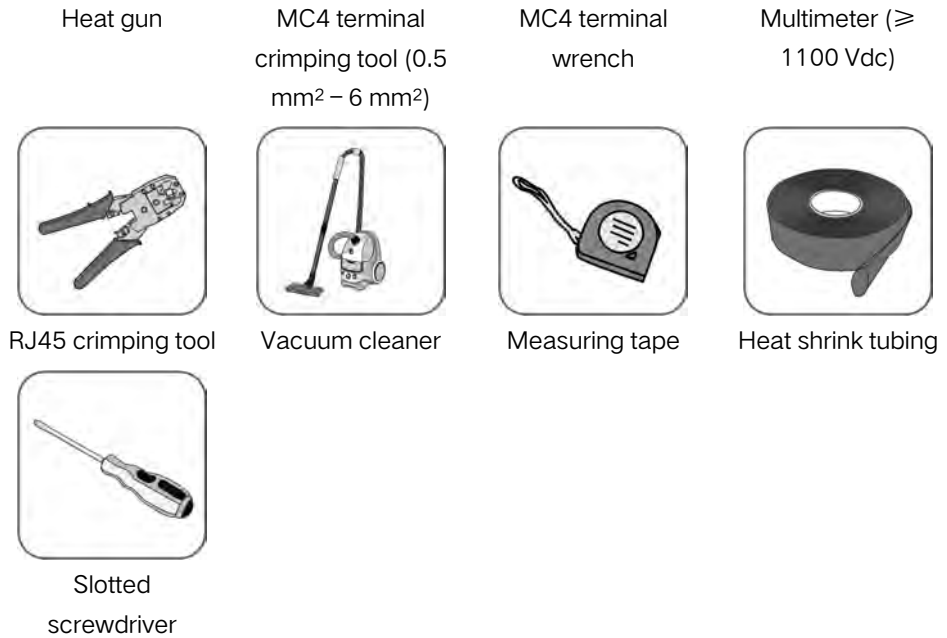

4.4 Moving the Inverter

Before installation, remove the inverter from the packing case and move it to the installation site. Follow the instructions below as you move the inverter:

- Always be aware of the weight of the inverter.
- Lift the inverter using the handles positioned on both sides of the inverter.
- Move the inverter by one or two people or by using a proper transport tool.
- Do not release the equipment unless it has been firmly secured.

4.5 Installing the Inverter

Inverter is installed on the wall by means of wall-mounting bracket and the expansion plug sets.

The expansion plug set shown below is recommended for the installation.

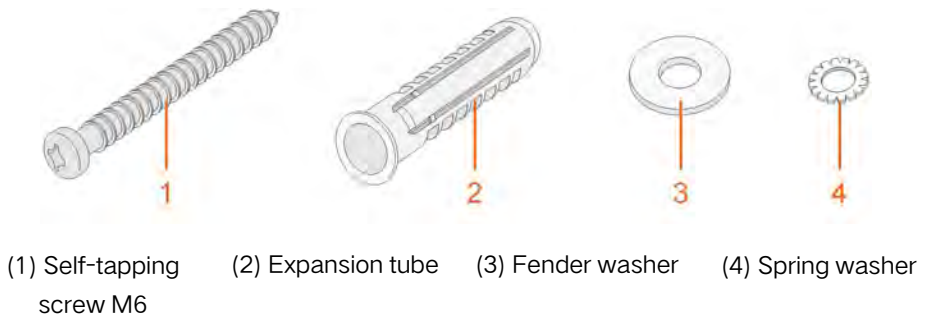

Step 1 Place the wall-mounting bracket to a proper position on the wall. Observe the level on the bracket and adjust until the bubble is in the middle position. Mark the positions and drill the holes.

NOTICE

The depth of the holes should be about 70 mm.

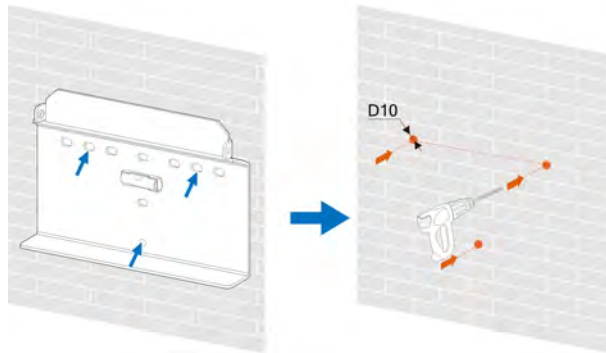

Step 2 Place the expansion tubes into the holes. Then secure the wall-mounting bracket to the wall firmly with the expansion bolt sets.

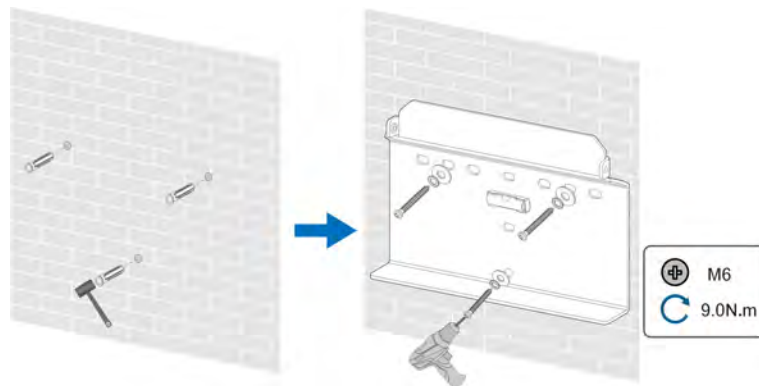

Step 3 Lift the inverter and slide it down along the wall-mounting bracket to make sure they match perfectly. Use the fastener set to lock the device.

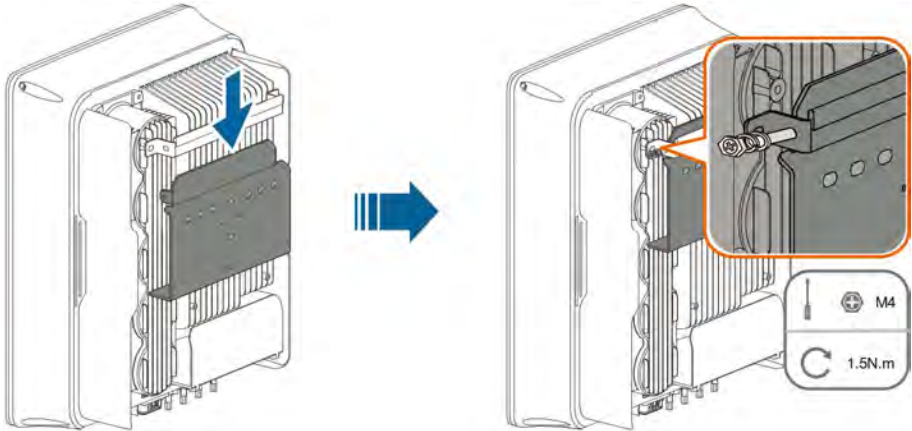

-- End

5 Electrical Connection

5.1 Safety Instructions

Prior to any electrical connections, keep in mind that the inverter has dual power supplies. It is mandatory for the qualified personnel to wear personal protective equipments (PPE) during the electrical work.

DANGER

Danger to life due to a high voltage inside the inverter!

- The PV string will generate lethal high voltage when exposed to sunlight.
- Before starting electrical connections, disconnect the DC and AC circuit breakers and prevent them from inadvertent reconnection.
- Ensure that all cables are voltage free before performing cable connection.

WARNING

- Any improper operations during cable connection can cause device damage or personal injury.
- Only qualified personnel can perform cable connection.
- All cables must be undamaged, firmly attached, properly insulated and adequately dimensioned.

NOTICE

Comply with the safety instructions related to the PV strings and the regulations related to the utility grid.

- All electrical connections must be in accordance with local and national standards.
- Only with the permission of the local utility grid company, the inverter can be connected to the utility grid.

5.2 Terminal Description

All electrical terminals are located at the bottom of the inverter.

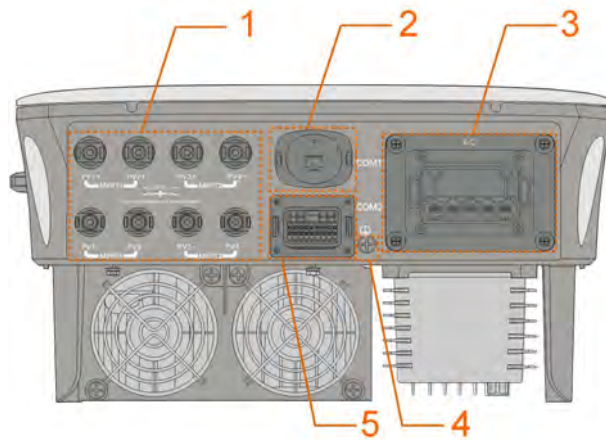



Figure 5-1 Terminals (SG20RT for example)

* The image shown here is for reference only. The actual product received may differ.

Table 5-1 Terminal Description

No.	Name	Description	Decisive Voltage Classification
1	PV1+, PV1 -, PV2+, PV2 -, PV3+, PV3 -, PV4+, PV4 -	MC4 terminals for PV input. The terminal number depends on inverter model.	DVC-C
2	COM1	Communication accessory port to be connected to WiNet-S communication module.	DVC-A
3	AC	AC terminal to connect to the grid.	DVC-C
4		Additional grounding terminal.	Not applicable
5	COM2	Communication connection for DI/ DRM, DO, Logger and smart energy meter.	DVC-A

The pin definition of COM2 terminal is shown in the following label.

RSD		NS		DRM			RS485-1	DO
RSD-1	RSD-2	NS-1	NS-2	D1/5	D3/7	R	A1	NO
B3	A3	B2	A2	D2/6	D4/8	C	B1	COM
RS485-3		Meter						

Figure 5-2 Label of COM2 Terminal

Table 5-2 Label Description of COM2 Terminal

Label	Description	
RSD	RSD-1, RSD-2	Reserved
NS	NS-1, NS-2	Reserved
DRM	D1/5, D2/6, D3/7, D4/8, R, C	For external Demand Response Enabling Device ("AU"/ "NZ")
RS485-1	A1, B1	For inverter daisy chain (Cannot be used simultaneously with COM1 port for WiNet-S)
DO	NO, COM	External alarm interface, e.g. light indicator and/or buzzer The external DC voltage should not be higher than 30 V and the current not higher than 1 A.
RS485-3	A3, B3	Reserved
Meter	A2, B2	Smart energy meter interface

5.3 Electrical Connection Overview

The electrical connection should be realized as follows:

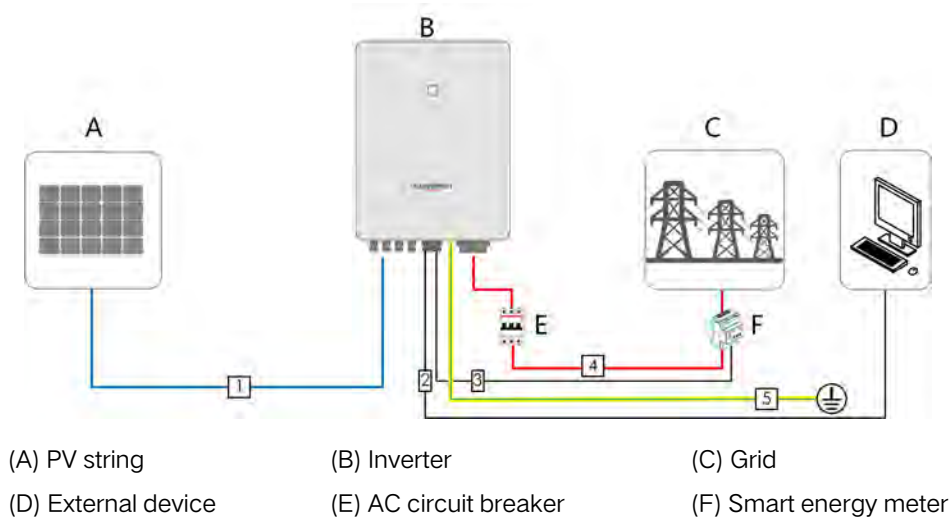

Table 5-3 Cable Requirements

No.	Cable	Type	Cable Diameter	Wire Conductor Cross-section
1	DC cable	Outdoor multi-core copper wire cable complying with 1100 V and 30 A standard	6 mm – 9 mm	4 mm ² – 6 mm ²
2	Ethernet cable	CAT 5E outdoor shielded network cable	5.3 mm – 7 mm	8 * 0.2 mm ²
3	Meter RS485 cable ⁽¹⁾	Shielded twisted pair	5.3 mm – 7 mm	2 * (0.5 – 1.0) mm ²
4	AC cable ⁽²⁾	Outdoor 5-core copper wire cable	SG3.0RT to SG12RT: 10 mm – 21 mm	SG3.0RT to SG12RT: 4 mm ² – 6 mm ²
			SG15RT to SG20RT: 14 mm – 25 mm	SG15RT to SG20RT: 6 mm ² – 10 mm ²
5	Additional Grounding cable	Outdoor single-core copper wire cable	The same as that of the PE wire in the AC cable	

(1) The cable requirements for **COM2** terminal connection are the same.

(2) All the AC wires should be equipped with correctly colored cables for distinguishing. Please refer to related standards about the wiring color.

5.4 Additional Grounding Connection

WARNING

- Since the inverter is transformerless, neither the negative pole nor the positive pole of the PV string must be grounded. Otherwise, the inverter will not operate normally.
- Connect the additional grounding terminal to the protective grounding point before AC cable connection, PV cable connection, and communication cable connection.
- The ground connection of this additional grounding terminal cannot replace the connection of the PE terminal of the AC cable. Make sure thoes terminals are both grounded reliably. SUNGROW shall not be held liable for any damage caused by the violation.

5.4.1 Additional Grounding Requirements

All non-current carrying metal parts and device enclosures in the PV power system should be grounded, for example, brackets of PV modules and inverter enclosure.

When there is only one inverter in the PV system, connect the additional grounding cable to a nearby grounding point.

When there are multiple inverters in the PV system, connect grounding points of all inverters and the PV array frames to the equipotential cable (according to the onsite conditions) to implement an equipotential connection.

Ensure that the grounding resistance should be less than 10 Ohm.

5.4.2 Connection Procedure

Additional grounding cable and OT/DT terminal are prepared by customers.

Step 1 Prepare the cable and OT/DT terminal.

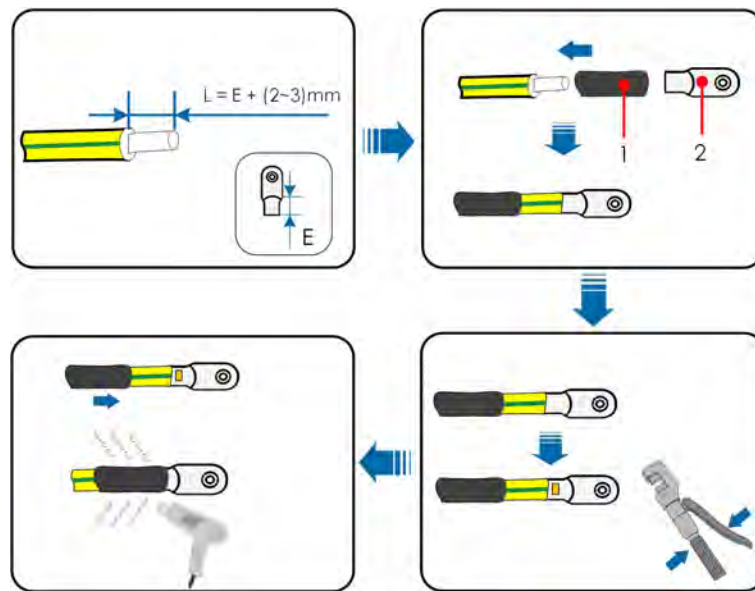

1: Heat shrink tubing

2: OT/DT terminal

Step 2 Remove the screw on the grounding terminal and fasten the cable with a screwdriver.

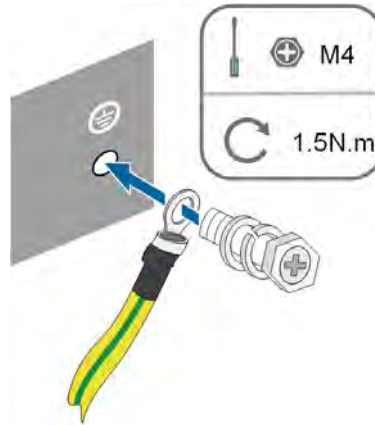

Step 3 Apply paint to the grounding terminal to ensure corrosion resistance.

-- End

5.5 AC Cable Connection

5.5.1 AC Side Requirements



Connect the inverter to the grid only after getting an approval from the local electric power company.

Before connecting the inverter to the grid, ensure the grid voltage and frequency comply with requirements, for which, refer to "**Technical Data**". Otherwise, contact the electric power company for help.

AC Circuit Breaker

An independent three or four-pole circuit breaker must be installed on the output side of the inverter to ensure safe disconnection from the grid. The recommended specifications are as follows.

Inverter Model	Recommended Specification
SG3.0RT/SG4.0RT/SG5.0RT/ SG6.0RT	16 A
SG7.0RT/SG8.0RT	20 A
SG10RT	25 A
SG12RT	32 A
SG15RT/SG17RT	40 A
SG20RT	50 A

NOTICE

- Determine whether an AC circuit breaker with greater overcurrent capacity is required based on actual conditions.
- Multiple inverters cannot share one circuit breaker.
- Never connect a load between the inverter and the circuit breaker.

Residual Current Monitoring Device

With an integrated universal current-sensitive residual current monitoring unit included, the inverter will disconnect immediately from the mains power once a fault current with a value exceeding the limit is detected.

However if an external residual current device (RCD) is mandatory, the switch must be triggered at a residual current of 300 mA (recommended), or it can be set to other values according to local regulations. For example in Australia, the inverter can use an additional 30 mA (type A) RCD in installations.

Multiple Inverters in parallel Connection

If multiple inverters are connected in parallel to the grid, ensure that the total number of parallel inverters does not exceed 5. Otherwise, please contact SUNGROW for technical scheme.

5.5.2 Assembling the AC Connector (< 15 kW)

The AC terminal block is on the bottom side of the inverter. AC connection is the three-phase-four-wire grid + PE connection (L1, L2, L3, N, and PE).

Step 1 Unscrew the swivel nut of the AC connector.

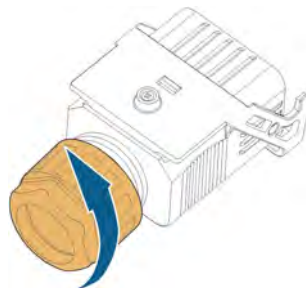

Step 2 Take out the terminal plug from the housing.

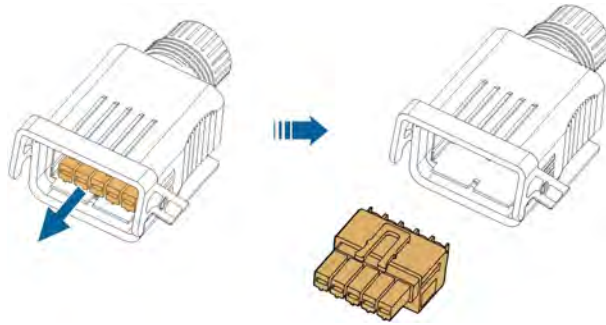

Step 3 Thread the AC cable of appropriate length through the swivel nut, the sealing ring and the housing.

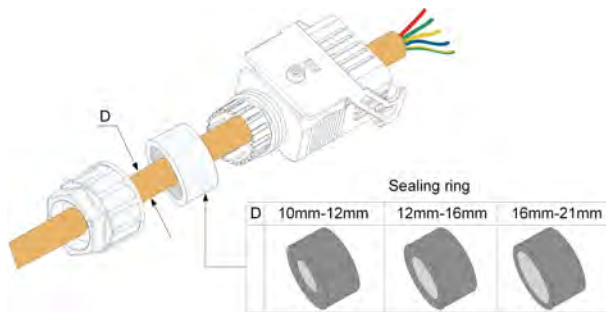

Step 4 Remove 45 mm of the cable jacket and 12 mm – 16 mm of the wire insulation.

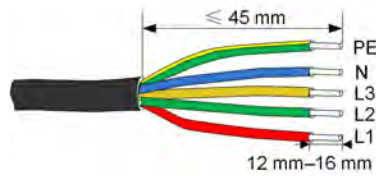

Step 5 Open the clamp on the terminal plug and insert the wires into the corresponding holes. Close the clamp and push the terminal plug into the housing until there is an audible click.

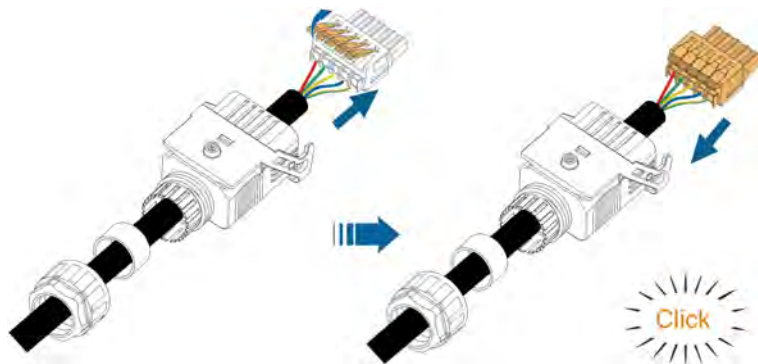

NOTICE

Observe the plug assignment. Do not connect any phase line to the "PE" terminal or PE wire to "N" terminal. Otherwise, unrecoverable damage to the inverter may follow.

Step 6 Ensure that the wires are securely in place by slightly pulling them. Tighten the swivel nut to the housing.

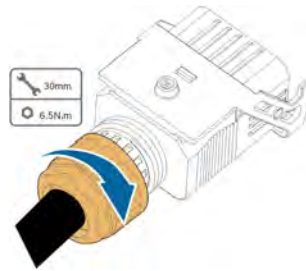

-- End

5.5.3 Installing the AC Connector (< 15 kW)

⚠ DANGER

High voltage may be present in inverter!

Ensure all cables are voltage-free before electrical connection.

Do not connect the AC circuit breaker until all inverter electrical connections are completed.

Step 1 Disconnect the AC circuit breaker and secure it against reconnection.

Step 2 Remove the waterproof lid from the AC terminal.



Step 3 Lift the locking part upwards and insert the AC connector into the AC terminal on the bottom side of the inverter. Then press the locking part and secure it with the screw.

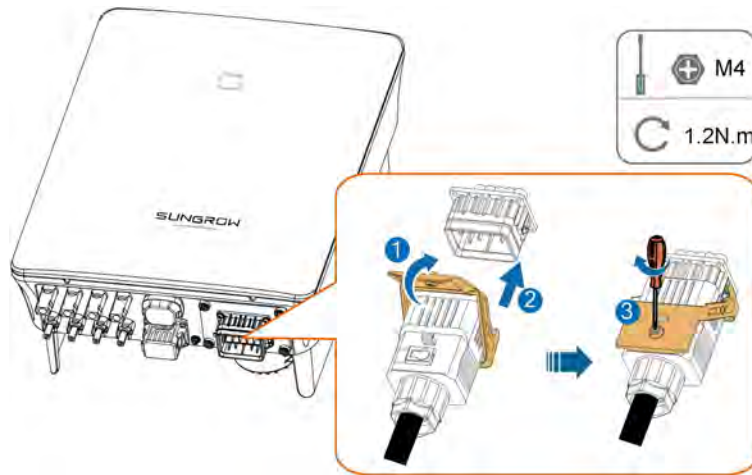

Step 4 Connect the PE wire to ground and the phase lines and the “N” line to AC circuit breaker. Then Connect the AC circuit breaker to electric board.

Step 5 Make sure all wires are firmly installed via the right torque tool or dragging the cables slightly.

-- End

5.5.4 Assembling the AC Connector (≥ 15 kW)

The AC terminal block is on the bottom side of the inverter. AC connection is the three-phase-four-wire grid + PE connection (L1, L2, L3, N, and PE).

Step 1 Unscrew the swivel nut of the AC connector.

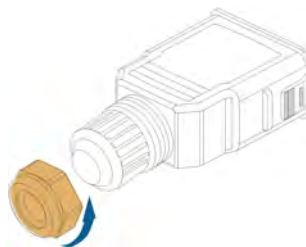

Step 2 (Optional) Remove the inner sealing ring if the cable diameter is 19 mm – 25 mm. Otherwise skip this step.

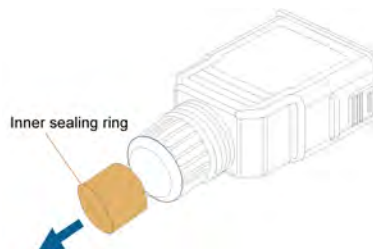

Step 3 Take out the terminal plug from the housing.

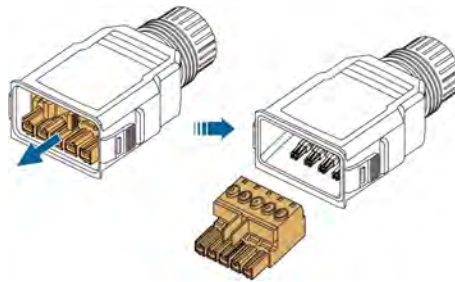

Step 4 Thread the AC cable of appropriate length through the swivel nut and the housing.

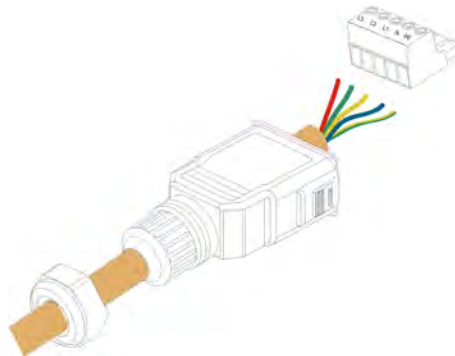

Step 5 Remove 80 mm – 90 mm of the cable jacket and 12 mm of the wire insulation.

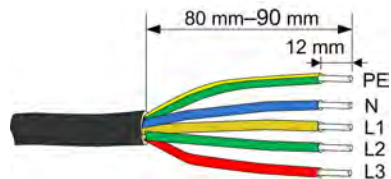

Step 6 (Optional) When using a multi-core multi-strand copper wire cable, connect the AC wire head to the cord end terminal (hand-tight). In case of single-strand copper wire, skip this step.

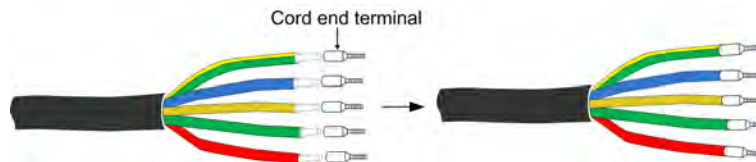

Step 7 Fix all the wires to the terminal plug according to the assignment and tighten to a torque of 1.2 N•m – 1.5 N•m with a screwdriver. Then push the terminal plug into the housing until there is an audible click.

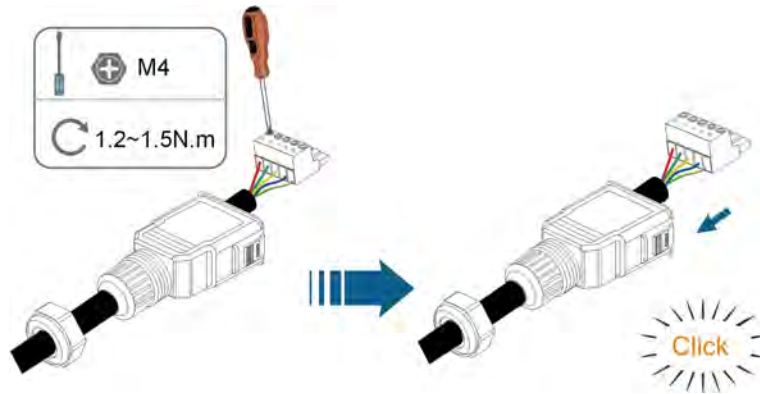
**NOTICE**

Observe the plug assignment. Do not connect any phase line to the "PE" terminal or PE wire to "N" terminal. Otherwise, unrecoverable damage to the inverter may follow.

Step 8 Ensure that the wires are securely in place by slightly pulling them. Tighten the swivel nut to the housing.

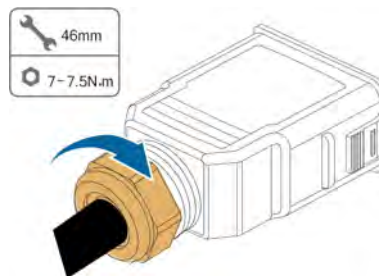

-- End

5.5.5 Installing the AC Connector (≥ 15 kW)

⚠ DANGER

High voltage may be present in inverter!
 Ensure all cables are voltage-free before electrical connection.
 Do not connect the AC circuit breaker until all inverter electrical connections are completed.

Step 1 Disconnect the AC circuit breaker and secure it against reconnection.

Step 2 Remove the waterproof lid from the AC terminal.

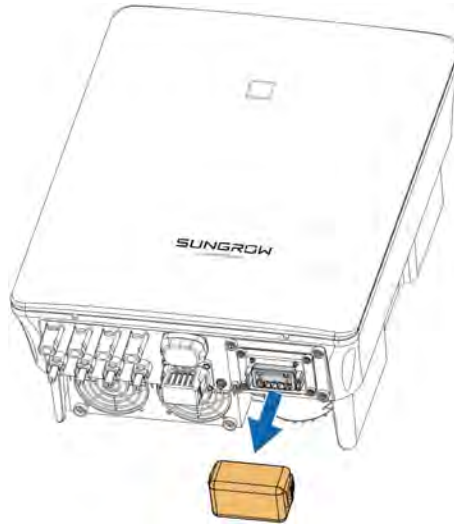

Step 3 Insert the AC connector into the **AC** terminal on the bottom of the inverter until there is an audible sound.

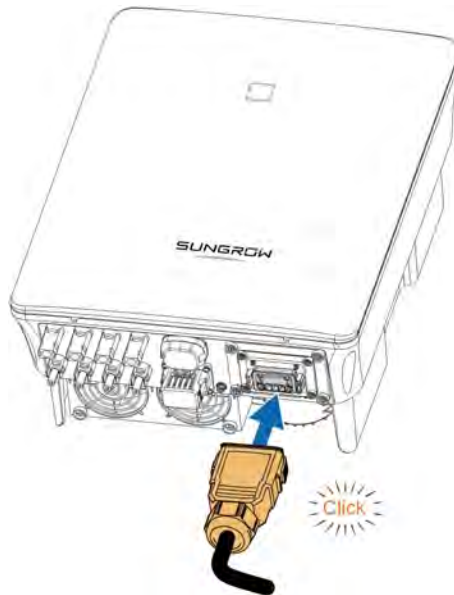

Step 4 (Optional) Secure the AC connector, as shown in the figure below.

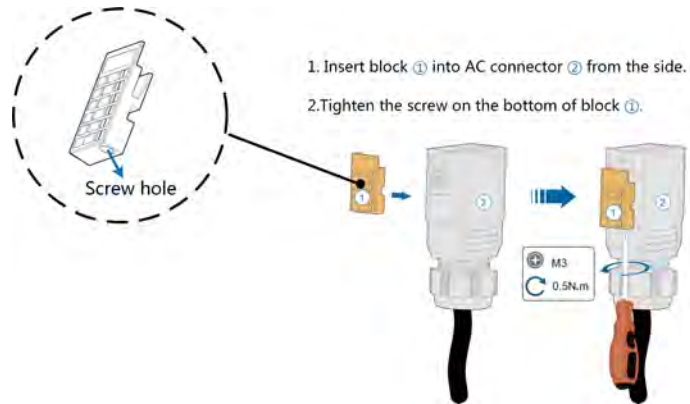

Step 5 Connect the PE wire to ground and the phase lines and the "N" line to AC circuit breaker. Then connect the AC circuit breaker to electric board.

Step 6 Make sure all wires are firmly installed via the right torque tool or dragging the cables slightly.

-- End

5.6 DC Cable Connection

⚠ DANGER

Danger of electric shock!

The PV array will generate lethal high voltage once exposed to sunlight.

⚠ WARNING

Make sure the PV array is well insulated to ground before connecting it to the inverter.

NOTICE

Risk of inverter damage! Observe the following requirements. Failure to do so will void guarantee and warranty claims.

- Make sure the maximum DC voltage and the maximum short circuit current of any string never exceed inverter permitted values specified in "Technical Data".
- Mixed use of different brand or model of PV modules in a PV string or a compromised PV string design composed with PV modules from rooftops of different orientation may not damage inverter but will cause system bad performance!
- The inverter enters standby state when the input voltage ranges between 1,000 V and 1,100 V. The inverter returns to running state once the voltage returns to the MPPT operating voltage range, namely, 160 V to 1,000 V.

5.6.1 PV Input Configuration

- The inverters SG3.0RT/SG4.0RT/SG5.0RT/SG6.0RT have two PV inputs, SG7.0RT/SG8.0RT/SG10RT/SG12RT have three PV inputs and SG15RT/SG17RT/SG20 have four PV inputs.
- The inverters have two MPP trackers. Each DC input area can operate independently.
- The PV strings to the same DC input area should have the same type, the same number of PV panels, identical tilt and identical orientation for maximum power.
- The PV strings to two DC input areas may differ from each other, including PV module type, number of PV modules in each string, angle of tilt, and installation orientation.

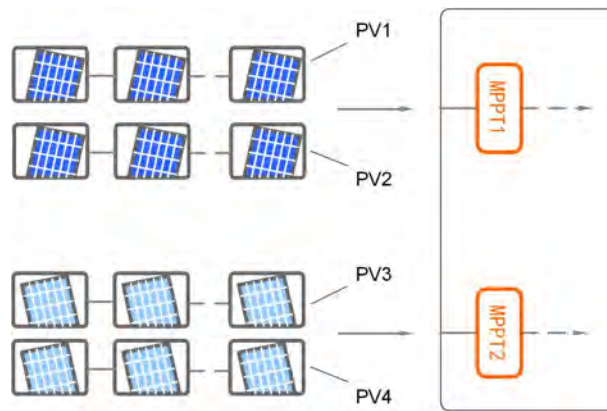

Figure 5-3 PV Input Configuration (SG20RT for example)

Prior to connecting the inverter to PV inputs, the specifications in the following table should be met:

Inverter Model	Open-circuit Voltage Limit	Max. current for input connector
All models	1100 V	30 A

The following figure shows the open-circuit voltage limits at different altitudes. Before configuring the PV panels, need to take this derating curve in consideration under high altitude situation.

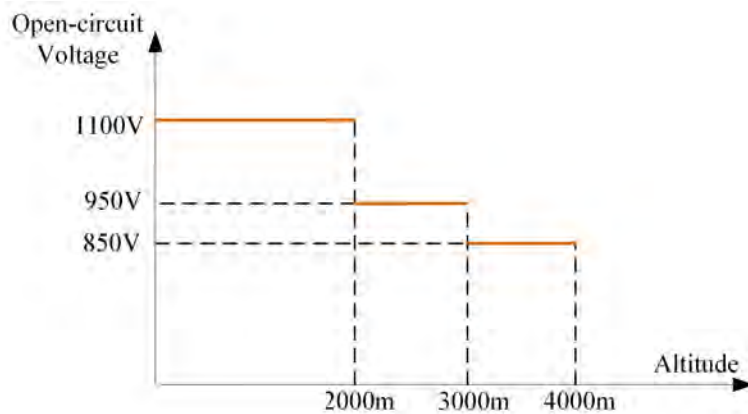

Figure 5-4 Open-circuit Voltage Derating Curve

5.6.2 Assembling the PV Connectors

⚠ DANGER

High voltage may be present in the inverter!

- Ensure all cables are voltage-free before performing electrical operations.
- Do not connect the AC circuit breaker before finishing electrical connection.

⚠ CAUTION

- Use MC4 DC terminals if the maximum input voltage is no more than 1,000 V.
- Use MC4-Evo2 DC terminals if the maximum input voltage is greater than 1,000 V. To purchase the MC4-Evo2 DC terminals, contact SUNGROW.
- Select appropriate DC terminals as required above. Otherwise, SUNGROW shall be held no liability for the damage caused.



SUNGROW provides corresponding PV connectors in the scope of delivery for quick connection of PV inputs. To ensure IP65 protection, use only the supplied connector or the connector with the same ingress of protection.

Step 1 Strip 7 mm – 8 mm of the insulation from each PV cable.

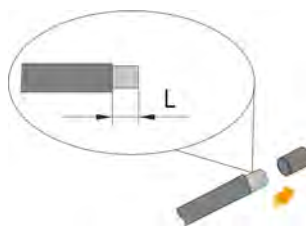

Step 2 Assemble the cable ends with the crimping pliers.

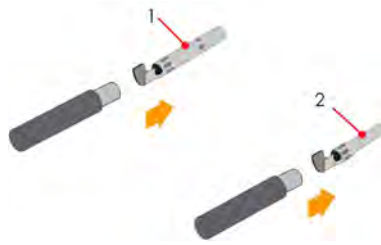

1: Positive crimp contact

2: Negative crimp contact

Step 3 For some countries such as Australia where the DC protection cover delivered separately need to be installed on site, please firstly lead the PV cables through the waterproof terminal on the DC protection cover before assembling the connector. See the guidance with the DC protection cover for details.

NOTICE

PV cables with connectors cannot go through the waterproof terminal on the DC protection cover. Rework may cause damage to the connectors, which will not be covered by the warranty.

Step 4 Lead the cable through cable gland, and insert it into the insulator until it snaps into place. Gently pull the cable backward to ensure firm connection. Tighten the cable gland and the insulator (torque 2.5 N.m to 3 N.m).

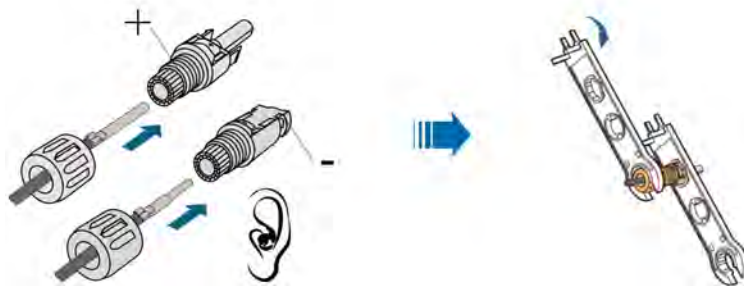

Step 5 Check for polarity correctness.

NOTICE

The inverter will not function properly if any PV polarity is reversed.

-- End

5.6.3 Installing the PV Connectors

Step 1 Rotate the DC switch to "OFF" position.

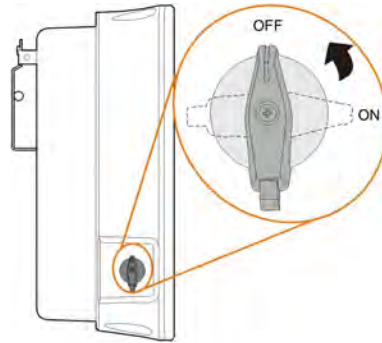

Step 2 Check the cable connection of the PV string for polarity correctness and ensure that the open circuit voltage in any case does not exceed the inverter input limit of 1,100 V.



Step 3 Connect the PV connectors to corresponding terminals until there is an audible click.

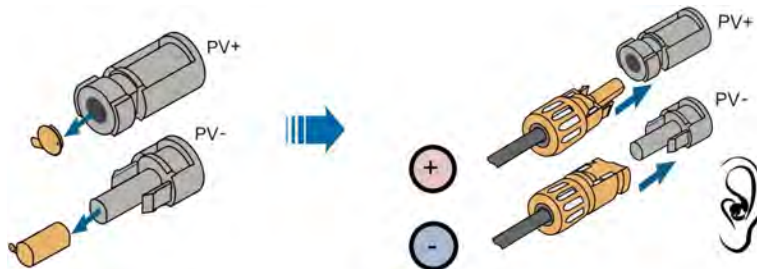

S005-E046

NOTICE

- Check the positive and negative polarity of the PV strings, and connect the PV connectors to corresponding terminals only after ensuring polarity correctness.
- Electric arc or contactor overtemperature may occur if the PV connectors are not firmly in place, and SUNGROW shall not be held liable for any damage caused due to this operation.

Step 4 Seal the unused PV terminals with the terminal caps.

-- End

5.7 WiNet-S Connection

The WiNet-S module supports Ethernet communication and WLAN communication. It is not recommended to use both communication methods at the same time.

For details, see the quick guide for the WiNet-S module.

5.7.1 Ethernet Communication

The WiNet-S communication cannot be used simultaneously with A1 and B1 terminals for RS485 daisy chain.

Step 1 (Optional) Strip the insulation layer of the communication cable with an Ethernet wire stripper, and lead the corresponding signal cables out. Insert the stripped communication cable into the RJ45 plug in the correct order, and crimp it with a crimper.

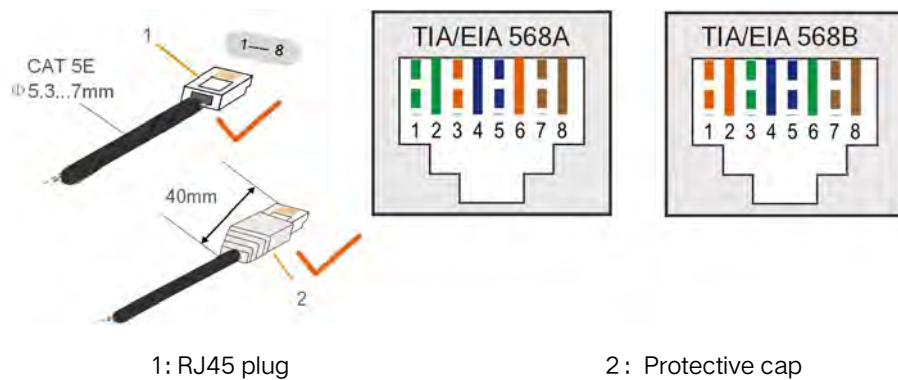

Skip this step if a standard network cable with RJ45 plug is prepared.

Step 2 Unscrew the swivel nut from the communication module and take out the inner sealing ring.

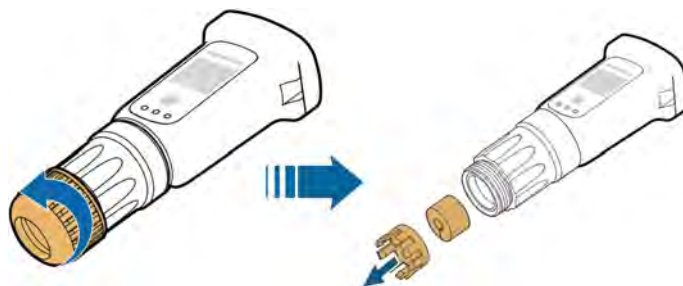

Step 3 Unscrew the housing from the communication module.

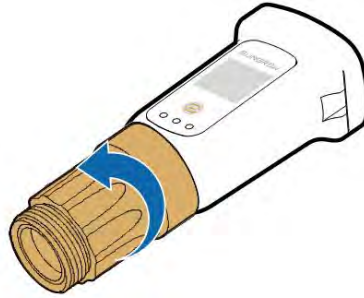

Step 4 Thread the network cable through the swivel nut and gasket. Afterwards, route the cable into the opening of the sealing. Finally, insert the cable through the housing.

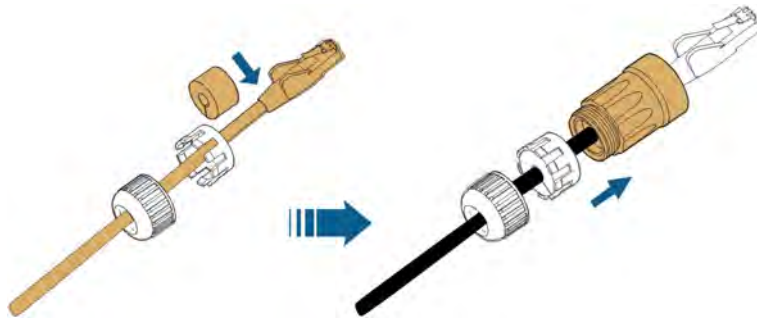

Step 5 Insert the RJ45 plug into the front plug connector until there is an audible click and tighten the housing. Install the gasket and fasten the swivel nut.

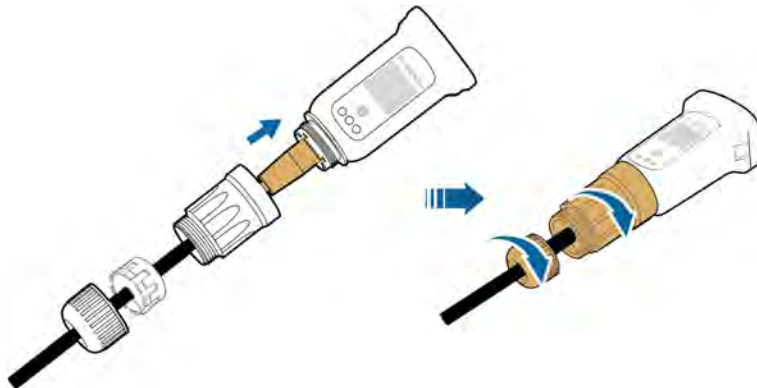

Step 6 Remove the waterproof lid from the COM1 terminal and install WiNet-S.

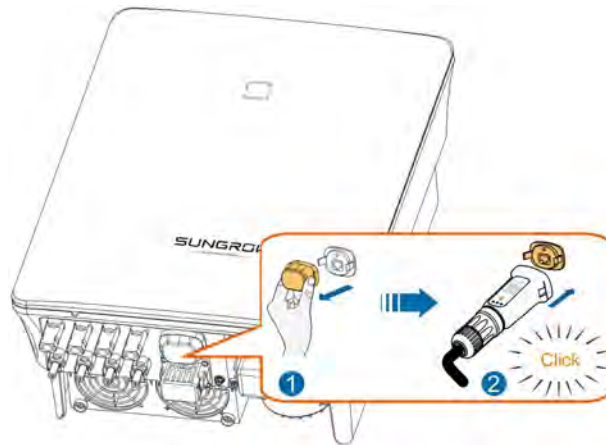

Step 7 Slightly shake it by hand to determine whether it is installed firmly.

-- End

5.7.2 WLAN Communication

Step 1 Remove the waterproof lid from the **COM1** terminal.

Step 2 Install the module. Slightly shake it by hand to determine whether it is installed firmly, as shown below.

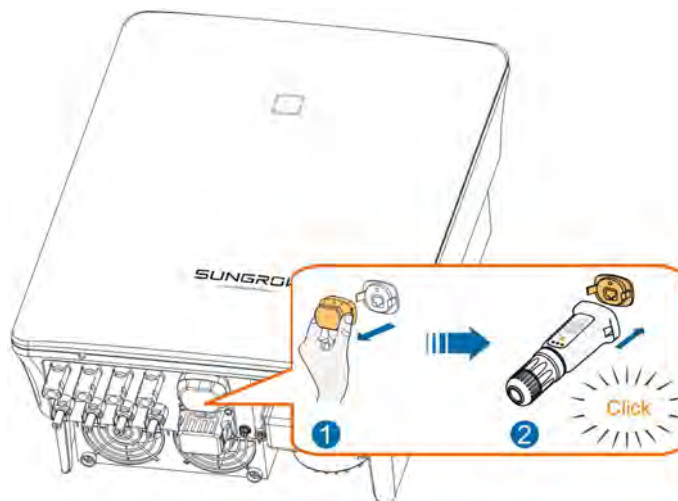

Step 3 Refer to the guide delivered with the module for the set-up.

-- End

5.8 Meter Connection

The Meter (A2, B2) terminals are designed to connect to a single Smart Energy Meter for the feed-in power function.

5.8.1 Assembling the COM Connector

Step 1 Unscrew the swivel nut from the connector.

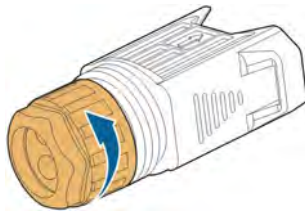

Step 2 Take out the terminal block.

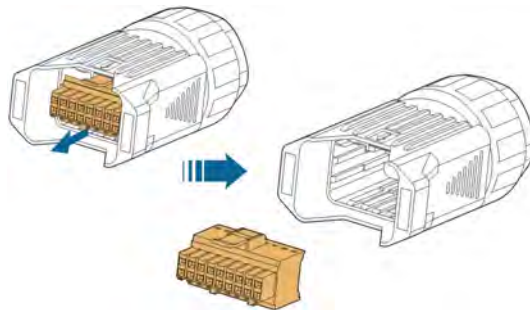

Step 3 Remove the seal and lead the cable through the cable gland.

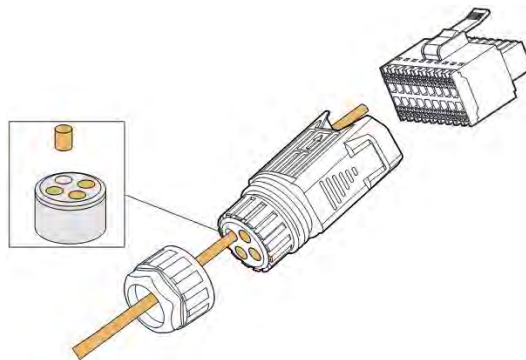

Step 4 Remove the cable jacket and strip the wire insulation.

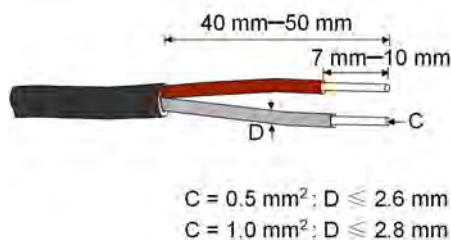

Step 5 (Optional) When using a multi-core multi-strand wire cable, connect the wire head to the cord end terminal. In case of single-strand copper wire, skip this step.

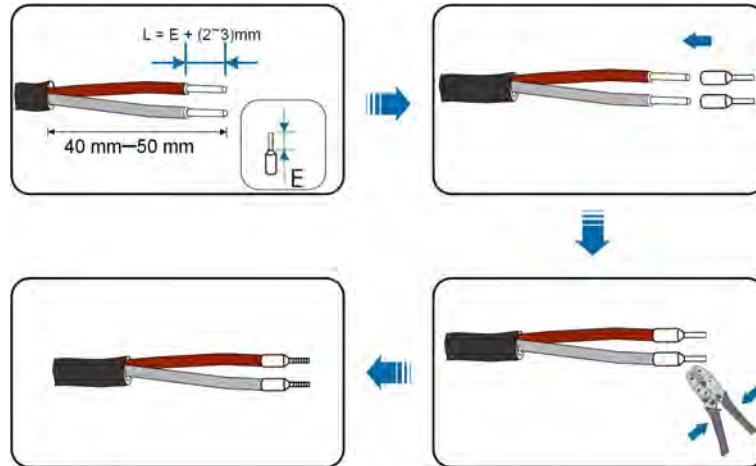

Step 6 Plug the wires or terminals into the corresponding terminals as shown in the following figure.

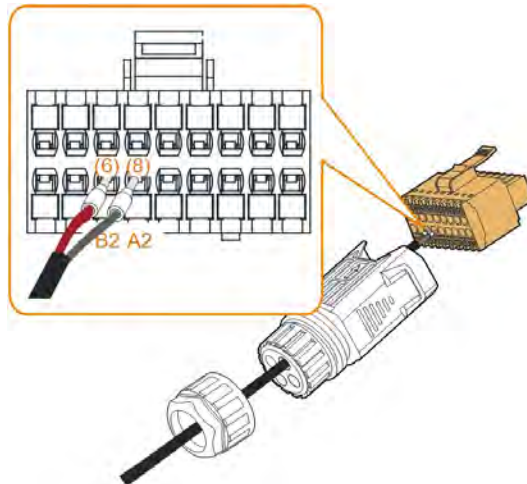
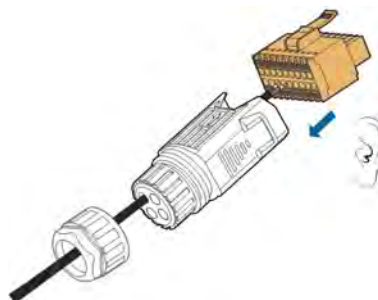
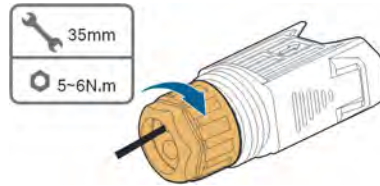

Figure 5-5 A2, B2 connection

Step 7 Ensure that the wires are securely in place by slightly pulling them and insert the terminal plug into the housing until there is an audible click.



Step 8 Fasten the swivel nut.



-- End

5.8.2 Installing the COM Connector

Step 1 Remove the waterproof lid from the COM2 connector.

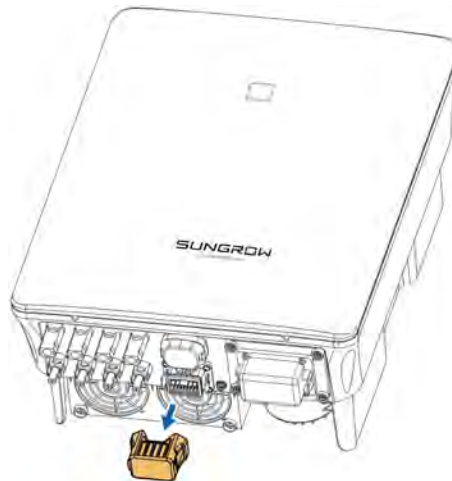

Step 2 Insert the COM connector into COM2 terminal on the bottom of the inverter until there is an audible click.

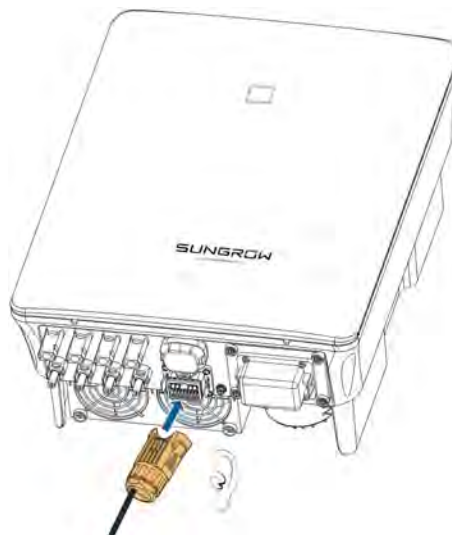

-- End

5.9 RS485 Connection

5.9.1 RS485 Communication System

The RS485 (A1, B1) connection can establish the communication between the inverter and an external device, as well as the communication between two inverters in parallel. In case of multiple inverters, all the inverters can be connected via RS485 cables in daisy chain manner.

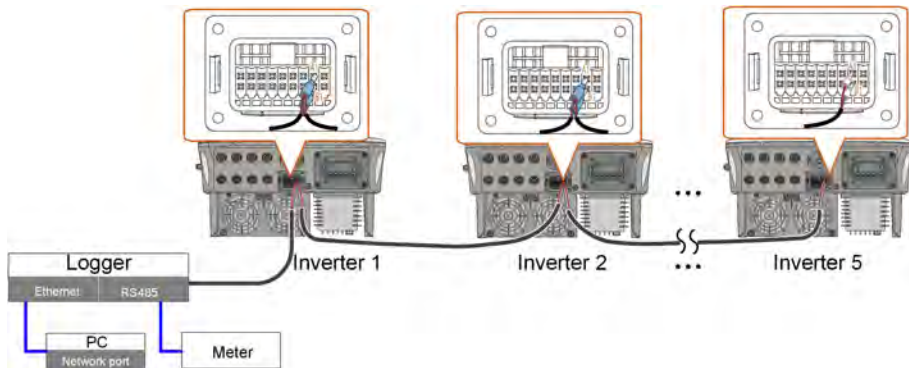

Figure 5-6 Multi-inverter Connection



- The maximum number of inverters allowed to be connected in the daisy chain is 5.
- The RS485 communication cable should be shielded twisted pair cables or shielded twisted pair Ethernet cables.
- The RS485 cable between two devices should be not longer than 10 m.
- The RS485 communication cannot be used simultaneously with COM1 port for WiNet-S.
- Refer to the manual of Logger for the communication connection to the meter.

5.9.2 Assembling the COM Connector

Step 1 Unscrew the swivel nut from the connector.

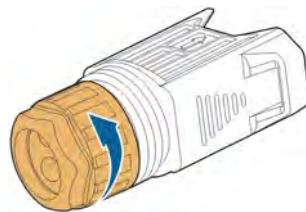

Step 2 Take out the terminal block.

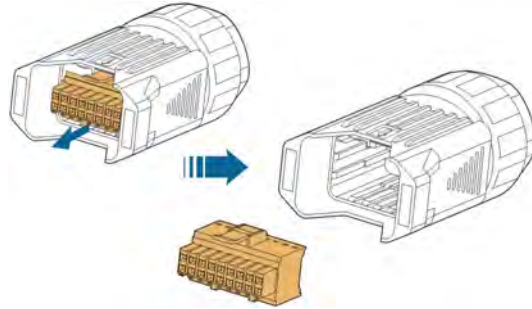

Step 3 Remove the seal and lead the cable through the cable gland.

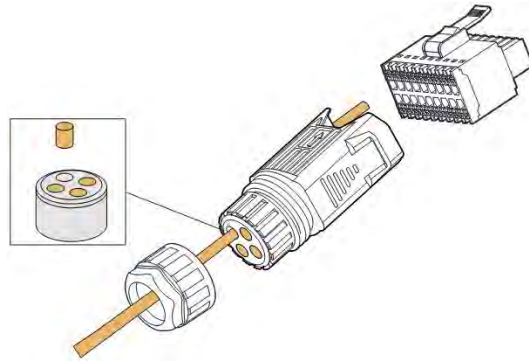

Step 4 Remove the cable jacket and strip the wire insulation.

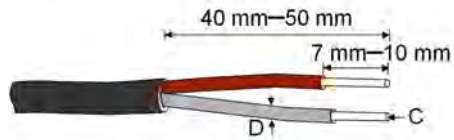

$C = 0.5 \text{ mm}^2; D \leq 2.6 \text{ mm}$

$C = 1.0 \text{ mm}^2; D \leq 2.8 \text{ mm}$

Step 5 (Optional) When using a multi-core multi-strand wire cable, connect the wire head to the cord end terminal. In case of single-strand copper wire, skip this step.

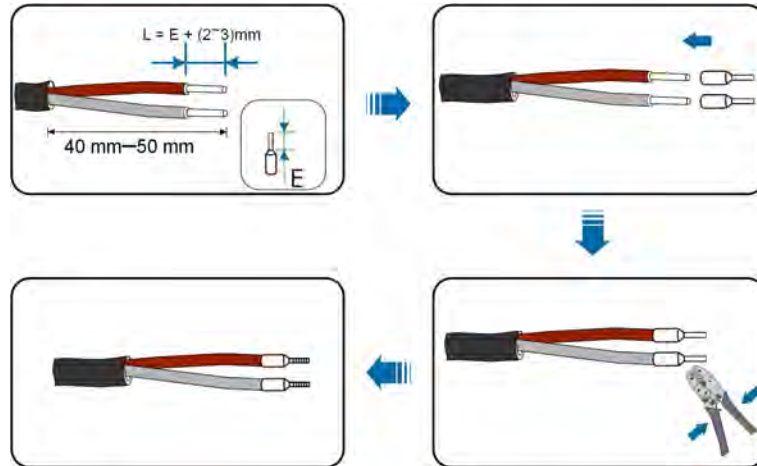

Step 6 Plug the wires or terminals into the corresponding terminals as shown in the following figure.

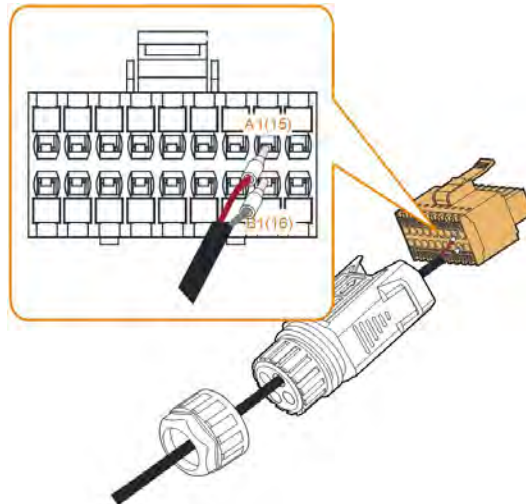
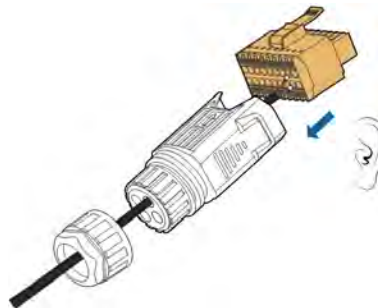

Figure 5-7 A1, B1 connection

Step 7 Ensure that the wires are securely in place by slightly pulling them and insert the terminal plug into the housing until there is an audible click.



Step 8 For RS485 daisy chain: Crimp two wires A to a two-wire core end terminal and two wires B to another terminal. Plug the terminals to A1 and B1 respectively.

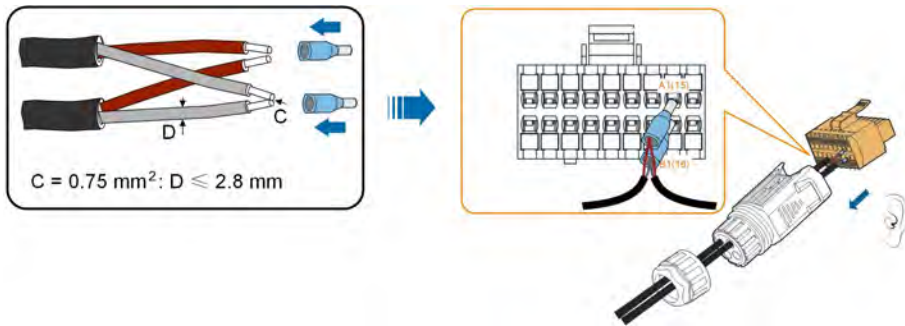
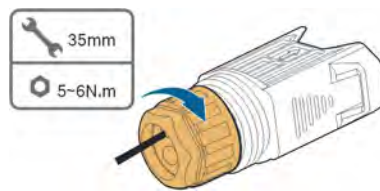

Figure 5-8 RS485 daisy chain connection

Step 9 Fasten the swivel nut.



-- End

5.9.3 Installing the COM Connector

Step 1 Remove the waterproof lid from the COM2 connector.



Step 2 Insert the COM connector into COM2 terminal on the bottom of the inverter until there is an audible click.

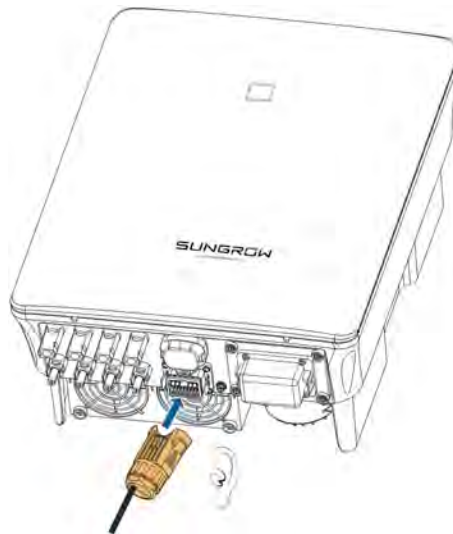

-- End

5.10 DO Connection

The inverter is equipped with a DO relay for an earth fault alarm. The additional equipment required is a light indicator and/or a buzzer that needs additional power supply.

Once fault occurs, the relay trips and the circuit is connected. The external indicator gets on. The relay remains triggered until the fault is removed.

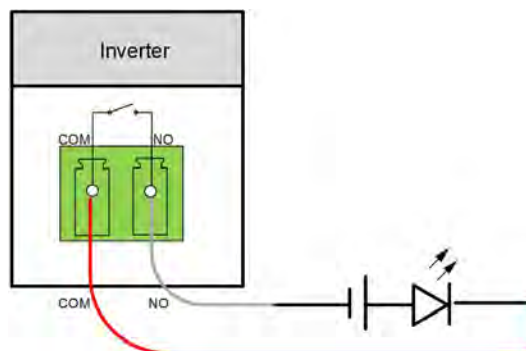
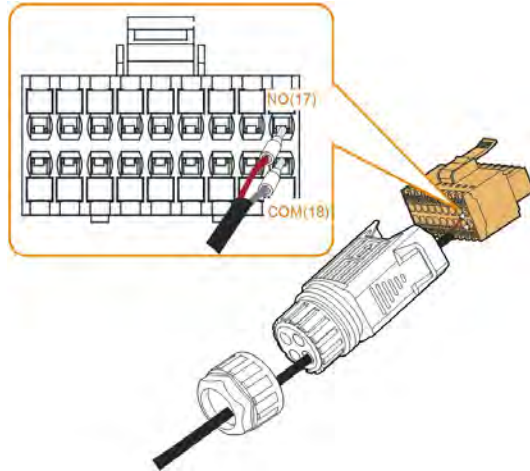

Figure 5-9 DO Normal Open Connect

The additional DC power supply should comply with related requirements:

- Max. voltage: 30 V
- Max. current: 1 A

Refer to section "[5.8.1 Assembling the COM Connector](#)" for detailed assembling procedure. Plug the wires to **NO** and **COM** terminals according to the labels on the bottom of the inverter.



Refer to section "5.9.3 Installing the COM Connector" to install the connector.

5.11 DRM Connection

In Australia and New Zealand, the inverter supports the demand response modes as specified in the standard AS/NZS 4777.

The following figure shows the wiring between the inverter and the external DRED.

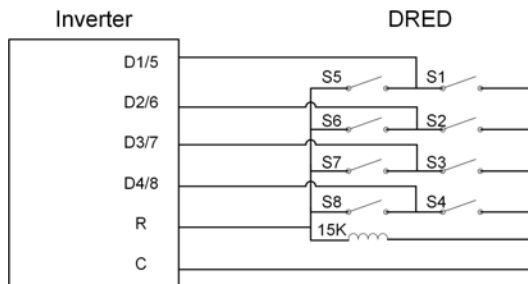
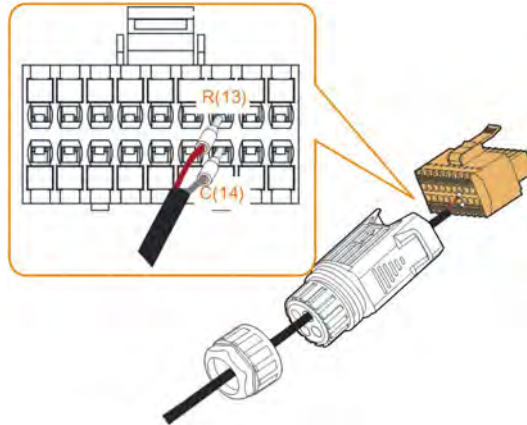

Table 5-4 Method of Asserting DRM

Mode	Asserted by Shorting Terminals on Inverter	Switch Operation on External DRED
DRM0	R & C	Close S1 and S5

Refer to section "5.8.1 Assembling the COM Connector" for detailed assembling procedure. Plug the wires to **R** and **C** terminals according the labels on the bottom of the inverter.



Refer to section "[5.9.3 Installing the COM Connector](#)" to install the connector.

6 Commissioning

6.1 Inspection before Commissioning

Check the following items before starting the inverter:

- All the installation sites are convenient for operation, maintenance and service.
- Check and confirm that all devices are firmly installed.
- Space for ventilation is sufficient for one inverter or multiple inverters.
- Nothing is left on the top of the inverter.
- The inverter and accessories are correctly connected.
- Cables are routed safely and protected against mechanical damage.
- The selection of the AC circuit breaker is in accordance with this manual and all applicable local standards.
- All unused terminals at the bottom of the inverter are properly sealed.
- Warning signs & labels are intact and legible.

6.2 Powering on the System

If all of the items mentioned above meet the requirements, proceed as follows to start up the inverter for the first time.

Step 1 Rotate the DC switch of the inverter to "ON" position.

Step 2 Turn on the AC circuit breaker (if applicable) between the inverter and the grid.

Step 3 Turn on the external DC switch (if applicable) between the inverter and the PV string.

Step 4 If the irradiation and grid conditions meet requirements, the inverter will operate normally. Observe the LED indicator to ensure that the inverter operates normally. Refer to "[2.4 Indicator Definition](#)" for details.

Step 5 Refer to the quick guide for WiNet-S for its indicator definition.

-- End

6.3 App Preparation

Step 1 Install the iSolarCloud App with latest version. Refer to "[7.2 Installing the App](#)".

Step 2 Register an account. Refer to "[7.3 Account Registration](#)". If you have got the account and password from the distributor/installer or SUNGROW, skip this step.

Step 3 Download the firmware package to the mobile device in advance. Refer to "[7.10.5 Firmware Update](#)". This is to avoid download failure due to poor on-site network signal.

-- End

6.4 Creating a Plant

Screenshots of creating a plant are for reference only. For details, refer to the actual screen.

Step 1 Open the App, tap  at the upper right corner and tap **Select Server**. Choose the same server as when registering.

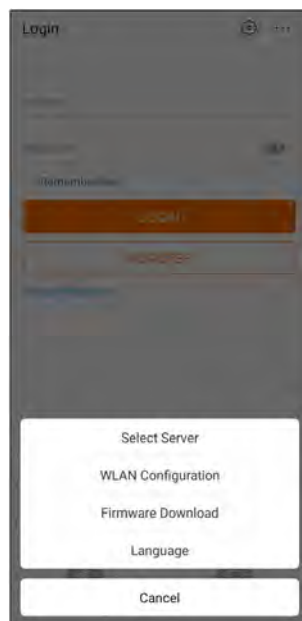



Figure 6-1 Selecting the Server

Step 2 Enter the account and password on the login screen and tap **Login** to enter the App home screen.

Step 3 If there is no plant, tap **Create power plant**. If there are existing plants, tap the icon  at the upper right corner to enter the creating screen.

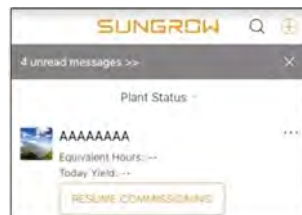

Figure 6-2 Creating Power Plant

Step 4 Select plant type to **RESIDENTIAL** and inverter type to **PV**.



Figure 6-3 Selecting Plant/Inverter Type

Step 5 Scan the QR code on the communication device or manually enter the serial number of the communication device. Tap **Next** after the QR code is identified or the serial number entered is correct and then tap **CONFIRM**. Your mobile device is thus connected to the WiNet-S successfully.

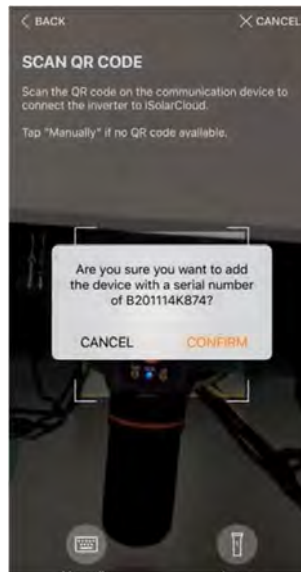

Figure 6-4 Connecting Mobile Device to WiNet-S

Step 6 Select the Internet access mode to **WLAN(CONNECTED)** or **ETHERNET** according to actual connection. The following description is for WLAN access mode.



Figure 6-5 Selecting Internet Access Mode

Step 7 The **EASYCONNECT INSTRUCTION** screen will prompt. Press the multi-function button on the WiNet-S module once to turn on EasyConnect mode. The WLAN indicator

on WiNet-S blinks quickly when this mode is turned on. Return to the App and the screen displays successful connection to the inverter WLAN. Tap **NEXT**.



Figure 6-6 Turn on EasyConnect Mode

NOTICE

The EasyConnect mode can be used only when the router is 2.4 GHz.
If the EasyConnect mode fails, refer to the WiNet-S quick guide for the instructions of other modes.

Step 8 Connect the inverter to router network. Enter network name and password. Tap **NEXT** and the screen display prompt information of successful connection to the router network.



Figure 6-7 Connecting Inverter to Router Network

-- End

6.5 Initializing the Device

The inverter is successfully connected to the router.

If there is no latest equipment upgrade package, skip steps 1 and 2.

The actual initializing procedure may differ due to different countries. Please follow the actual App guidance.

Step 1 If a latest equipment upgrade package is available, the following prompt window pops up. Tap **UPDATE NOW** to download the latest update package.

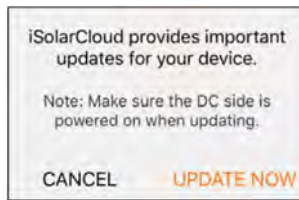

Figure 6-8 Upgrade Reminder

Step 2 After download, it would take around 15 minutes to update. After successful upgrade, the screen will show the version numbers before and after the upgrade as well as the upgrade time. Tap **NEXT**.



Figure 6-9 Upgrading Inverter

NOTICE

If the communication equipment is upgraded, after successful upgrade, check and confirm that the phone is connected to the inverter WLAN.

Step 3 Tap **Country/Region** and select the country where the inverter is installed at. The supported countries and corresponding settings are as follows.

Supported Country	Setting
Australia ("AU")	Australia
New Zealand ("NZ")	New Zealand
Poland("PL")	Poland
Countries not listed above	Other 50Hz or Other 60Hz

NOTICE

The parameter **Country/Region** must be set to the country (region) where the inverter is installed at. Otherwise, the inverter may report errors.

Step 4 When the country is set to Australia, additionally set the applicable network service provider and then the grid type.

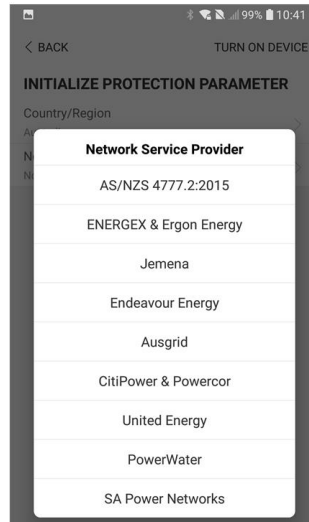

The image shown here is for reference only. Refer to the actual interface for the supported network service providers.

Table 6-1 Description of Network Service Provider and Grid Type

Network Service Provider	Grid Type
AS/NZS 4777.2:2015	/
ENERGEX & Ergon Energy	<ul style="list-style-type: none"> • STNW1170: single-phase < 10 kVA & three-phase < 30 kVA • STNW1174: 30 kVA < P_n ≤ 1500 kVA
Jemena	<ul style="list-style-type: none"> • ≤ 10 kVA per phase (or 30 kVA per three phase) • ELE GU 0014: 30 kVA – 200 kVA
Endeavour Energy	MDI 0043
Ausgrid	NS194
CitiPower & Powercor	<ul style="list-style-type: none"> • ≤ 5 kVA for single-phase & 30 kVA for three-phase • > 30 kVA three-phase
United Energy	<ul style="list-style-type: none"> • UE-ST-2008.1: ≤ 10 kVA for single-phase & 30 kVA for three-phase • UE-ST-2008.2: > 30 kVA three-phase

Network Service Provider	Grid Type
PowerWater	AS/NZS 4777.2:2015
SA Power Networks	<ul style="list-style-type: none"> • TS129-2019: < 10 kW for single-phase & 30 kW for three-phase • TS130-2017: > 30 kW & ≤ 200 kW • TS131-2018: > 200 kW

Step 5 Initialize parameters according to local grid requirements, including grid type, reactive power regulation mode, etc. The screen displays that the inverter is successfully configured.



Figure 6-10 Initializing Parameters

-- End

6.6 Configuring the Plant

The inverter is successfully added to the plant and initialized. Refer to the guidance in previous sections.

The distributor/installer who creates a plant for the end user needs to get the end user's e-mail address. In configuring a plant, the e-mail address is required, and each e-mail address can be registered only once.

Step 1 The App screen will display the added inverter. Tap **NEXT** to configure the plant.



Figure 6-11 Display the Added Inverter

Step 2 Fill in the plant information. The fields marked with * must be filled in.

← BACK × CANCEL

CONFIGURE PLANT

Enter plant information

- Plant Name: B201114K874
- Country/Region: [Dropdown]
- Time Zone: [Dropdown]
- Plant Address: [Text] Locating...
- Postal Code: [Text]
- Grid-connected Date: 2021-02-05

NEXT

Figure 6-12 Entering Plant Information

Step 3 (Optional) Fill in the tariff information. The electricity price can be set to a specific value or Time-of-Use tariff.

← BACK × CANCEL

CONFIGURE TARIFF

Enter tariff information to establish your plant revenue

- Unit: CNY
- Feed-in Tariff (CNY/kWh): [Text]
- Time-of-Use Tariff: [Text]
- Consumption Tariff (CNY/kWh): [Text]
- Time-of-Use Tariff: [Text]

NEXT

Figure 6-13 Entering Tariff Information

Step 4 Fill in the end user's e-mail address. The first time you fill in the end user's e-mail address, the system will create an account for the end user and send an email to the end user. The end user can activate the account via the email.



The Distributor/installer creates plants for the end user and can manage the plants by default.



Figure 6-14 Entering Owner's e-mail

Step 5 Tap **NEXT** to wait for the inverter to connect to the iSolarCloud.

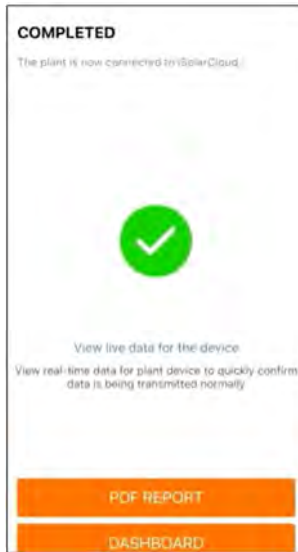

Figure 6-15 Configuration Completed

Step 6 (Optional) Tab **View live data for the device**, tick **Inverter** or **Total Plant Devices** and tab **ALL PLANTS OPEN**. The clock symbol indicates that the live data view function is successfully enabled. Tab the inverter to view the live data about voltage, current, power or curve.

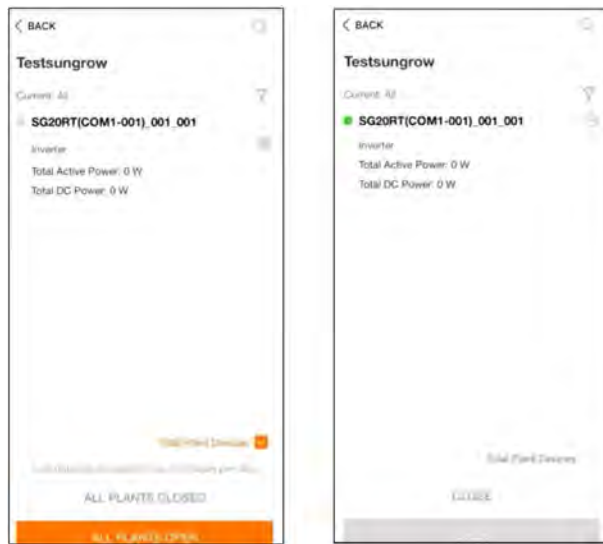

Figure 6-16 Live Data View Function Setting



Consult Sungrow service for the devices that support live data function.

Step 7 Tab **BACK** to the **COMPLETED** screen. Tab **PDF REPORT** to export the plant configuration report.

Step 8 Tab **BACK** to the **COMPLETED** screen. Tab **DASHBOARD** to return and manually refresh the page until the newly created plant is displayed with status commissioned.

-- End

7 iSolarCloud App

7.1 Brief Introduction

The iSolarCloud App can establish communication connection to the inverter via the WLAN, providing remote monitoring, data logging and near-end maintenance on the inverter. Users can also view inverter information and set parameters through the App.

* To achieve direct login via WLAN, the wireless communication module developed and manufactured by SUNGROW is required. The iSolarCloud App can also establish communication connection to the inverter via Ethernet connection.



- This manual describes only how to achieve near-end maintenance via WLAN direct connection.
- Screenshots in this manual are based on the V2.1.6 App for Android system, and the actual interfaces may differ.

7.2 Installing the App

Method 1

Download and install the App through the following application stores:

- MyApp (Android, mainland China users)
- Google Play (Android, users other than mainland China ones)
- App store (iOS)

Method 2

Scan the following QR code to download and install the App according to the prompt information.



The App icon appears on the home screen after installation.



7.3 Account Registration

The account distinguishes two user groups, end user and distributor/installer.

- The end user can view plant information, create plants, set parameters, share plants, etc.
- The distributor/installer can help the end user to create plants, manage, install, or maintain plants, and manage users and organizations.

Step 1 Tap **REGISTER** to enter the registration screen.

Step 2 Select **End user** or **Distributor/Installer** to enter the corresponding screen.

Figure 7-1 Selecting User Group

Step 3 Fill in the registration information, including server selection, email, verification code, password and affirmation, country (region) and time zone. The distributor/installer has the permission to fill in the company name and the code of upper level distributor/installer.



The code of upper level distributor/installer can be obtained from the upper level distributor/installer. Only when your organization belongs to the upper level distributor/installer organization, can you fill in the corresponding code.

Step 4 Tick **Accept privacy protocol** and tap **Register** to finish the registration operation.

-- End

7.4 Login

7.4.1 Requirements

The following requirements should be met:

- The AC and DC sides or the AC side of the inverter is powered-on.
- The WLAN function of the mobile phone is enabled.
- The mobile phone is within the coverage of the wireless network produced by the communication module.

7.4.2 Login Procedure

Step 1 Press the multi-function button on the WiNet-S module 3 times to enable the WLAN hotspot. No password is required and the valid time is 30 minutes.



Figure 7-2 Enabling the WLAN Hotspot

Step 2 Connect the mobile phone to the WLAN network named as "SG-xxxxxxxx" (-xxxxxxxx is the serial number indicated on the side of the communication module).

Step 3 Open the App to enter the login screen. Tap **Local ACCESS** to enter the next screen.

Step 4 Select **WLAN** and select the device (SN), then enter the password and tap **LOGIN**.



The default account is "user" and the initial password is "pw1111" which should be changed for the consideration of account security. Tap "More" at the lower right corner on home page and choose "Change Password".

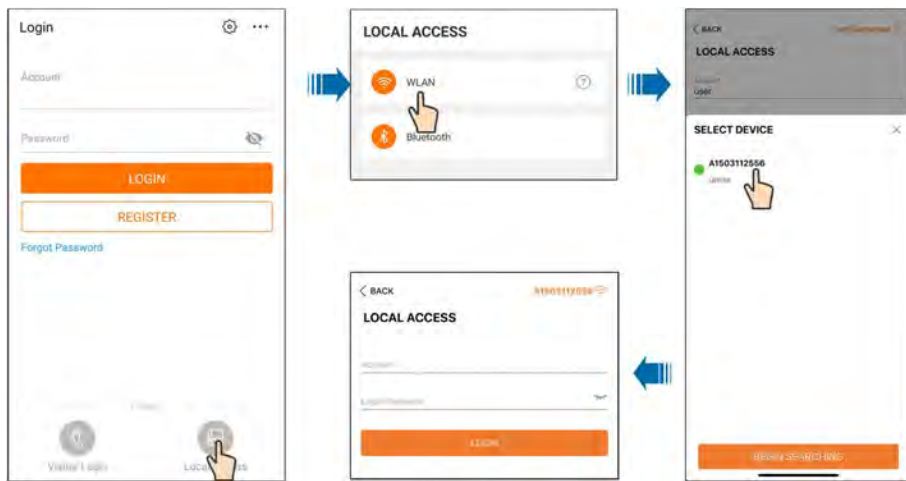

Figure 7-3 WLAN Local Access

Step 5 If the inverter is not initialized, navigate to the quick setting screen to initialize the protection parameters. For details, please refer to "Initial Settings".

NOTICE

The "Country/Region" must be set to the country where the inverter is installed at. Otherwise, the inverter may report errors.



Figure 7-4 WLAN Local Access

Step 6 After finishing the settings, tap **TUNR ON DEVICE** at the upper right corner and the device will be initialized. The App will send start instructions and the device will start and operate.

Step 7 After initialization settings, the App will return automatically to the home page.

-- End

7.5 Initial Settings

Tap **Country/Region** and select the country where the inverter is installed. For countries except Australia and Germany, the initialization is completed.

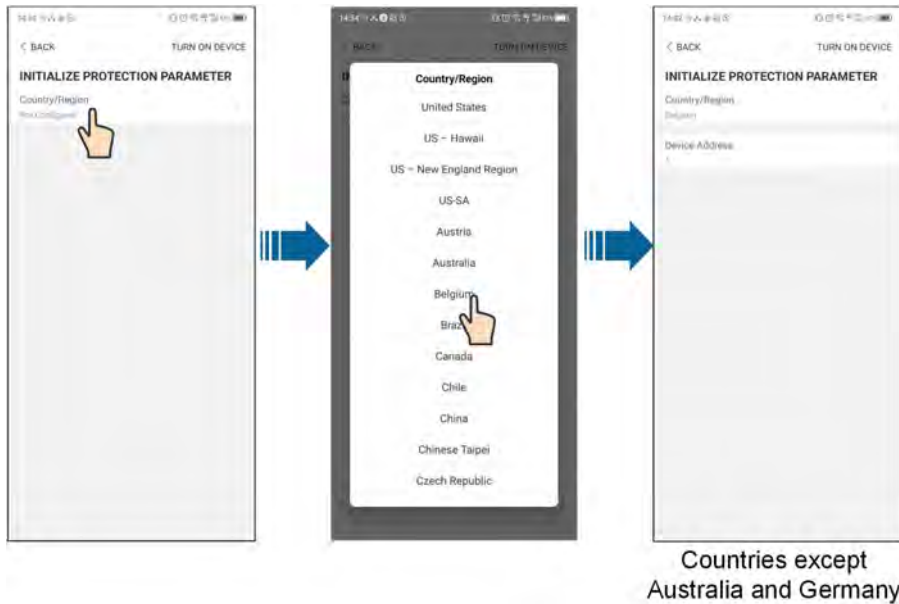

The actual initializing procedure may differ due to different countries. Please follow the actual App guidance.

For some countries, you should initialize parameters according to local grid requirements. For details, see 6.5 Initializing the Device.

7.6 Function Overview

The App provides parameter viewing and setting functions, as shown in the following figure.

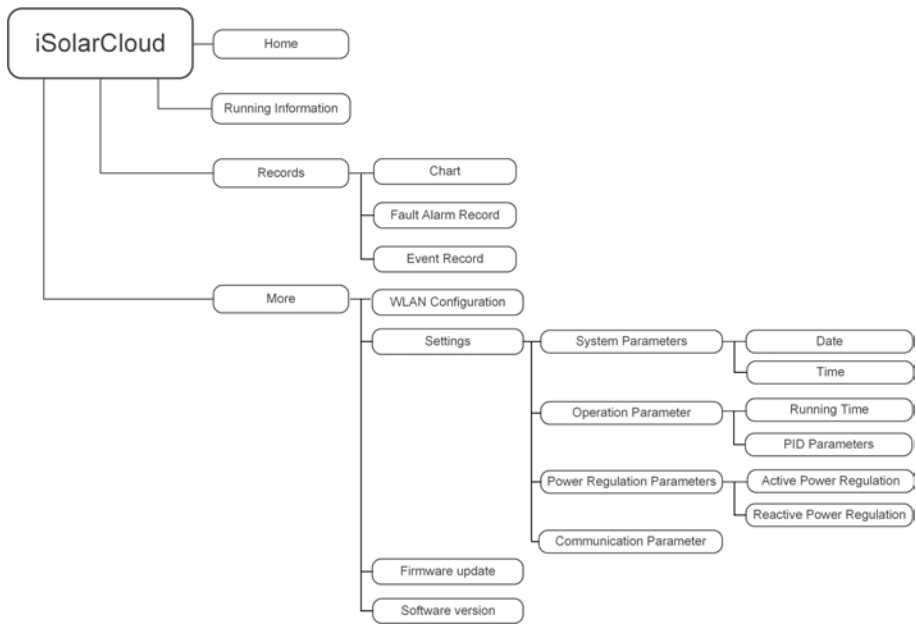

Figure 7-5 App Function Menu

7.7 Home

Home page of the App is shown in the following figure.

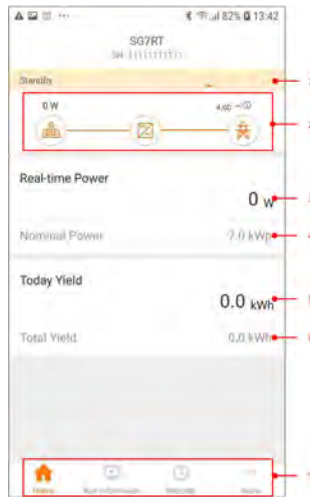



Figure 7-6 Home

Table 7-1 Home Page Description

No.	Name	Description
1	Inverter state	Present operation state of the inverter
2	Energy flow chart	Shows the PV power generation power, feed-in power, etc. The line with an arrow indicates energy flow between connected devices, and the arrow pointing indicates energy flow direction.
3	Real-time power	Shows the present output power of the inverter.
4	Nominal power	Shows the installed power of the inverter.
5	Today yield	Shows today power generation of the inverter
6	Total yield	Shows accumulative power generation of the inverter
7	Navigation bar	Includes menus of "Home", "Run Information", "Records" and "More".

If the inverter runs abnormally, the fault icon  will appear on the upper left corner of the screen. Users can tap the icon to view detailed fault information and corrective measures.

7.8 Run Information

Tap **Run Information** on the navigation bar to enter the screen showing running information, slide the screen upwards to view all detailed information.

Table 7-2 Description of Run Information

Item	Description
PV information	Shows voltage and current of every PV string.
Inverter information	Shows basic information such as running state, on-grid running time, negative voltage to grid, bus voltage, internal air temperature, inverter efficiency, etc.
Input	Shows total DC power, voltage and current of MPPT1 and MPPT2.
Output	Shows daily/monthly/annual/total yield, total active/reactive/apparent power, total power factor, grid frequency, phase voltage and current.
Meter information	Shows active power and phase active power of the meter.

7.9 Records

Tap **Records** on the navigation bar to enter the screen showing event records, as shown in the following figure.

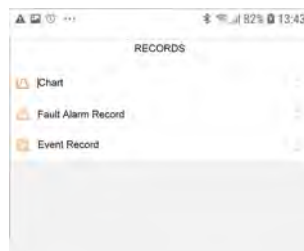
**Figure 7-7** Records

Chart

Tap **Chart** to enter the screen showing daily power generation, as shown in the following figure.



Figure 7-8 Chart

The App displays power generation records in a variety of forms, including daily power generation graph, monthly power generation histogram, annual power generation histogram and total power generation histogram.

Table 7-3 Description of Power Curve

Item	Description
Daily	Daily curve that indicates the real-time power.
Month	Monthly curve that indicates daily yield and equivalent hours in a month.
Year	Annual curve that indicates monthly yield and equivalent hours in a year.
Total	A curve that indicates annual yield and equivalent hours since installation.

Fault Alarm Record

Tap **Fault Alarm Record** to enter the screen, as shown in the following figure.

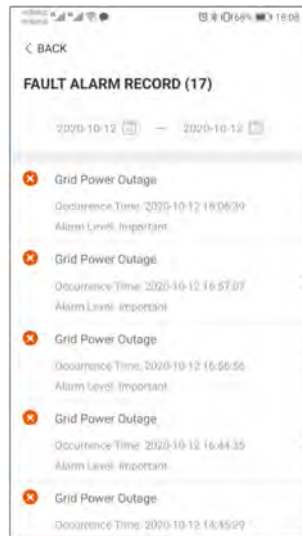



Figure 7-9 Fault Alarm Record



Click  to select a time segment and view corresponding records.

Select one of the records in the list and click the record, to view the detailed fault info as shown in following figure.



Figure 7-10 Detailed Fault Alarm Information

Event Record

Tap **Event Record** to enter the screen, as shown in the following figure.

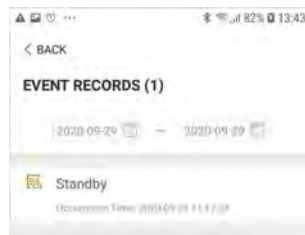



Figure 7-11 Event Record



Click  to select a time segment and view corresponding records.

7.10 More

Tap **More** on the navigation bar to enter the corresponding screen, as shown in the following figure.

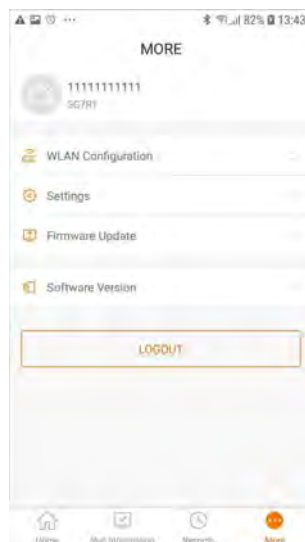

Figure 7-12 More

In addition to viewing the WLAN configuration and App software version, the **More** screen supports the following operations:

- Set parameters including inverter system parameters, operation parameters, power regulation parameters and communication parameters.
- Upgrade inverter firmware.

7.10.1 System Parameters

Tap **Settings**→**System Parameters** to enter the corresponding screen, as shown in the following figure.



Figure 7-13 System Parameters

Boot/Shutdown

Tap **Boot/Shutdown**, on which boot/shutdown instruction can be sent to the inverter. For Australia and New Zealand, when the DRM state is DRM0, the "Boot" option will be prohibited.

Date/Time

The correct system time is very important. Wrong system time will directly affect the data logging and power generation value. The clock is in 24-hour format.

7.10.2 Operation Parameters

Running Time

Tap **Settings**→**Operation Parameters**→**Running Time** to enter the corresponding screen, on which you can set the "Connecting Time" and "Reconnecting Time".



Figure 7-14 Running Time

PID Parameters

Tap **Settings**→**Operation Parameters**→**PID Parameters** to enter the corresponding screen, on which you can set "Connecting Time" and "Reconnecting Time".

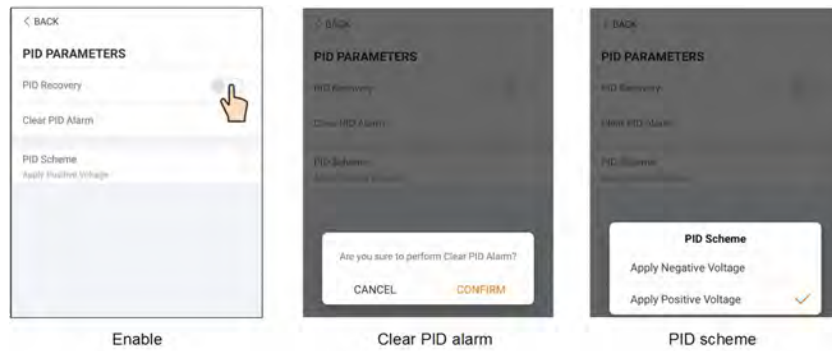

Figure 7-15 PID Setting

Table 7-4 PID Parameter Description

Parameter	Description
PID Recovery	Set enabling/disabling of the PID night recovery function. PID night recovery functions between 22:00 pm and 5:00 am by default.
Clear PID alarm	If ISO impedance abnormality or PID function exception is detected during running of the PID function, the inverter reports a PID false alarm and reminds the user to take corresponding measures. After processing, clear the alarm via this parameter.
PID Scheme	Apply negative or positive voltage.



For the selection of negative or positive voltage, please consult the supplier of PV panels.

After the PID night recovery function is enabled, the fault indicator on the inverter front panel turns green.

7.10.3 Power Regulation Parameters

Active Power Regulation

Tap **Settings**→**Power Regulation Parameters**→**Active Power Regulation** to enter the screen, as shown in the following figure.

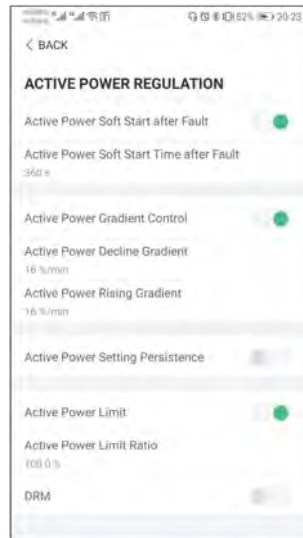

Figure 7-16 Active Power Regulation

Table 7-5 Description of Active Power Regulation Parameters

Parameter	Description	Range
Active Power Soft Start after Fault	Switch for activating/deactivating the function of active power soft start after a fault occurs	On/Off
Active Power Soft Start Time after Fault	The soft start time required for raising active power from 0 to rated value after a fault occurs	1 s – 1200 s
Active Power Gradient Control	Set whether to enable active power gradient control	On/Off
Active Power Decline Gradient	Decline gradient of inverter active power per minute	3 %/min – 6000 %/min
Active Power Rising Gradient	Rising gradient of inverter active power per minute	3 %/min – 6000 %/min
Active Power Setting Persistence	Switch for activating/deactivating the function of active power setting persistence	On/Off
Active Power Limit	Switch for limiting active power	On/Off
Active Power Limit Ratio	The ratio of active power limit to rated power in percentage	0.0 % – 110.0 %
DRM	Switch for activating/deactivating the DRM function	On/Off

Reactive Power Regulation

Tap **Settings**→**Power Regulation Parameters**→**Reactive Power Regulation** to enter the screen, as shown in the following figure.



Figure 7-17 Reactive Power Regulation

Table 7-6 Description of Reactive Power Regulation Parameters

Parameter	Description	Range
Reactive Power Setting Persistence	Switch for activating/deactivating the function of reactive power setting persistence	On/Off
Reactive Power Regulation Mode	Off/PF/Qt/Q(P)/Q(U)	Off/PF/Qt/Q(P)/Q(U)
Reactive Response	Switch for activating/deactivating the function of reactive response	On/Off
Reactive Response Time	Time for reactive response	0.2 s

"Off" Mode

The reactive power regulation function is disabled. The PF is fixed at +1.000.

"PF" Mode

The power factor (PF) is fixed and the reactive power is regulated by the parameter PF. The PF ranges from 0.8 leading to 0.8 lagging.

- Leading: the inverter is sourcing reactive power to the grid.
- Lagging: the inverter is injecting reactive power into the grid.

"Qt" Mode

In the Qt mode, the reactive power can be regulated by the parameter Q-Var limits (in %). The system rated reactive power is fixed, the system injects reactive power according to the delivered reactive power ratio. The "Reactive Power Ratio" is set through the App.

The setting range of the reactive power ratio is from -100 % to 100 %, corresponding to the ranges of inductive and capacitive reactive power regulation respectively.

"Q(P)" Mode

The PF of the inverter output varies in response to the output power of the inverter.

Table 7-7 "Q(P)" Mode Parameters Explanation

Parameter	Explanation	Range
Q(P) Curve	Select corresponding curve according to local regulations	A, B, C*
QP_P1	Output power at point P1 on the Q(P) mode curve (in %)	20.0 % – 100.0 %
QP_P2	Output power at point P2 on the Q(P) mode curve (in %)	20.0 % – 100.0 %
QP_P3	Output power at point P3 on the Q(P) mode curve (in %)	20.0 % – 100.0 %
QP_K1	Power factor at point P1 on the Q(P) mode curve	Curve A/C: 0.800 to 1.000
QP_K2	Power factor at point P2 on the Q(P) mode curve	Curve B: -0.600 to 0.600
QP_K3	Power factor at point P3 on the Q(P) mode curve	
QP_EnterVoltage	Voltage for Q(P) function activation (in %)	100.0 % – 110.0 %
QP_ExitVoltage	Voltage for Q(P) function deactivation (in %)	90.0 % – 100.0 %
QP_ExitPower	Power for Q(P) function deactivation (in %)	1.0 % – 20.0 %
QP_EnableMode	Unconditional activation/deactivation of Q(P) function	Yes, No

* Curve C is reserved and consistent with Curve A currently.

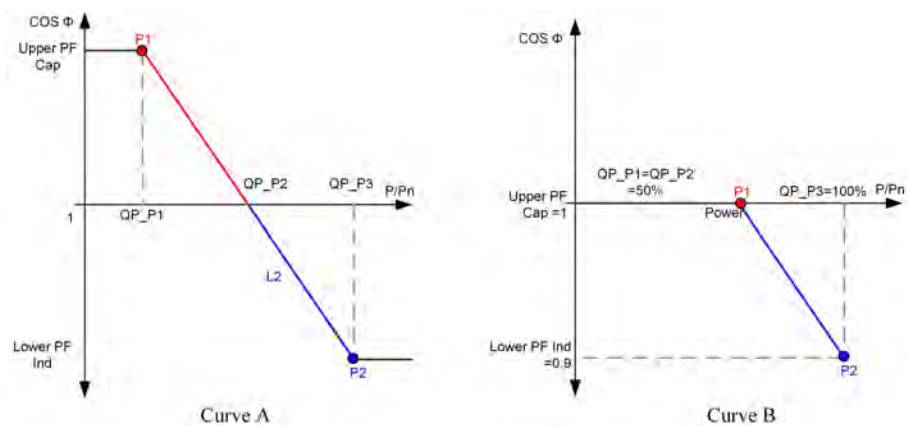

Figure 7-18 Reactive Power Regulation Curve in Q(P) Mode

"Q(U)" Mode

The reactive power output of the inverter varies in response to the grid voltage.

Table 7-8 "Q(U)" Mode Parameter Explanation

Parameter	Explanation	Range
Q(U) curve	Select corresponding curve according to local regulations	A, B, C*
Hysteresis Ratio	Voltage hysteresis ratio on the Q(U) mode curve	0.0 % – 5.0 %
QU_V1	Grid voltage limit at point P1 on the Q(U) mode curve (in %)	80.0 % – 100.0 %
QU_V2	Grid voltage limit at point P2 on the Q(U) mode curve (in %)	80.0 % – 110.0 %
QU_V3	Grid voltage limit at point P3 on the Q(U) mode curve (in %)	100.0 % – 120.0 %
QU_V4	Grid voltage limit at point P4 on the Q(U) mode curve (in %)	100.0 % – 120.0 %
QU_Q1	Value of Q/Sn at point P1 on the Q(U) mode curve (in %)	-60.0 % to 0.0 %
QU_Q2	Value of Q/Sn at point P2 on the Q(U) mode curve (in %)	-60.0 % to 60.0 %
QU_Q3	Value of Q/Sn at point P3 on the Q(U) mode curve (in %)	-60.0 % to 60 %
QU_Q4	Value of Q/Sn at point P4 on the Q(U) mode curve (in %)	0.0 % to 60.0 %
QU_EnterPower	Active power for Q(U) function activation (in %)	20.0 % – 100.0 %
QU_ExitPower	Active power for Q(U) function deactivation (in %)	1.0 % – 20.0 %
QU_EnableMode	Unconditional activation/deactivation of Q(U) function	Yes, No, Yes (- Limited by PF)
QU_Limited PF Value	Preset PF value	0 – 0.95

* Curve C is reserved and consistent with Curve A currently.

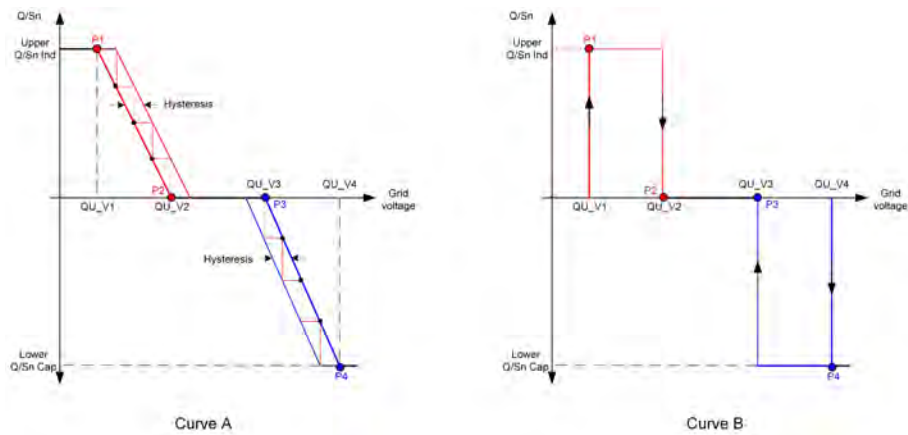

Figure 7-19 Reactive Power Regulation Curve in Q(U) Curve

7.10.4 Communication Parameters

Tap **Settings**→**Communication Parameters** to enter the corresponding screen, as shown in the following figure. The device address ranges from 1 to 246.

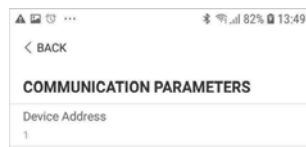



Figure 7-20 Communication Parameters

7.10.5 Firmware Update

To avoid download failure due to poor on-site network signal, it is recommended to download the firmware package to the mobile device in advance.

Step 1 Enable the "Mobile data" of the mobile device.

Step 2 Open the App, tap  at the upper right corner and select **Firmware Download**.

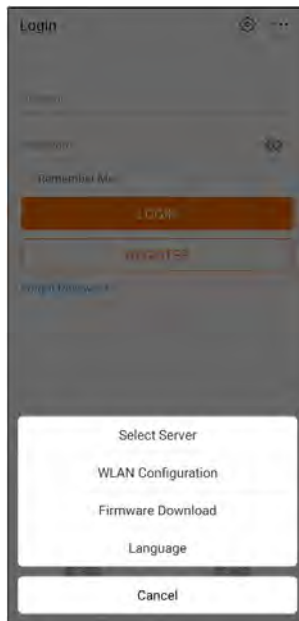

Figure 7-21 Firmware Download

Step 3 Select the firmware from the file list and download. Tap **Downloaded** to view successfully downloaded firmware package.



Figure 7-22 Downloading Firmware Package

Step 4 Login the App via local access mode. Refer to "[7.4.2 Login Procedure](#)".

Step 5 Tab **More** on the App home screen and then tab **Firmware upgrade**. Select the desired upgrade package to upgrade the firmware.

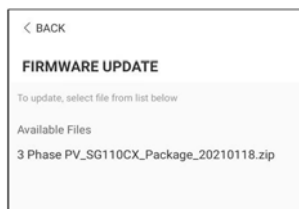

Figure 7-23 Updating Firmware

-- End

8 System Decommissioning

8.1 Disconnecting the Inverter

For maintenance or other service work, the inverter must be switched off.

Proceed as follows to disconnect the inverter from the AC and DC power sources. Lethal voltages or damage to the inverter will follow if otherwise.

Step 1 Disconnect the external AC circuit breaker and secure it against reconnection.

Step 2 Rotate the DC switch to the "OFF" position for disconnecting all of the PV string inputs.

Step 3 Wait about 10 minutes until the capacitors inside the inverter completely discharge.

Step 4 Ensure that the DC cable is current-free via a current clamp.

Step 5 Insert a MC4 wrench into the notch and press the wrench with an appropriate force to remove the DC connector.

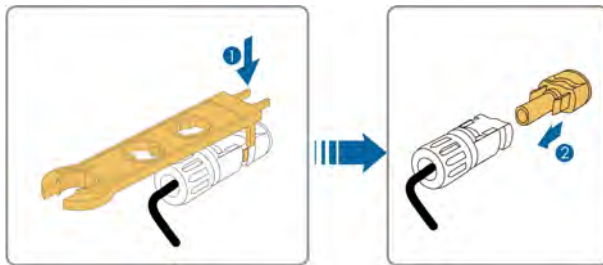

Step 6 Optional: Remove the block with the Phillips screwdriver.

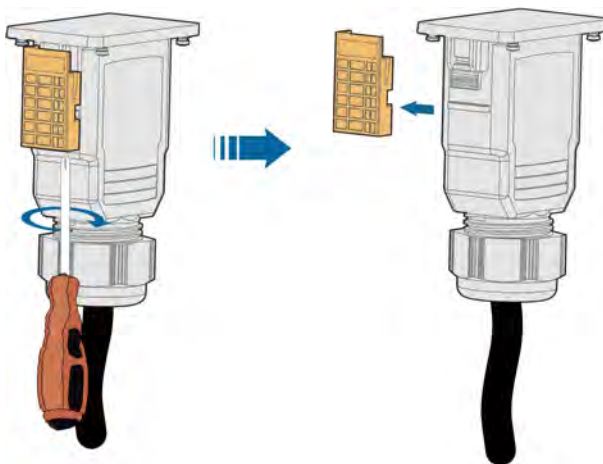

Step 7 Lay the tool in the location of snap and press the tool down to remove the AC connector. Ensure that the AC wiring terminals are voltage-free via a multimeter, and remove the AC wires and communication wires.

Step 8 Install the MC4 waterproof plugs.



For further disconnection and reconnection instructions, please visit the webpage of respective component manufacturer.

-- End

8.2 Dismantling the Inverter

⚠ CAUTION

Risk of burn injuries and electric shock!

Do not touch any inner live parts until for at least 10 minutes after disconnecting the inverter from the utility grid and the PV input.

Step 1 Refer to "[5 Electrical Connection](#)" for the inverter disconnection of all cables in reverse steps.

Step 2 Dismantle the inverter referring to "[4 Mechanical Mounting](#)" in reverse steps.

Step 3 If necessary, remove the wall-mounting bracket from the wall.

Step 4 If the inverter will be reinstalled in the future, please refer to "[3.2 Inverter Storage](#)" for a proper conservation.

-- End

8.3 Disposal of the Inverter

Users take the responsibility for the disposal of the inverter.

NOTICE

Some parts and devices of the inverter, such as the capacitors, may cause environmental pollution.

Do not dispose of the product together with household waste but in accordance with the disposal regulations for electronic waste applicable at the installation site.

9 Troubleshooting and Maintenance

9.1 Troubleshooting

When an alarm occurs, the alarm information can be viewed through the App.

Alarm ID and corrective measures are as follows:

Alarm ID	Alarm Name	Corrective Measures
001	Grid overvoltage	<p>Generally, the inverter will be reconnected to the grid after the grid recovers. If the alarm occurs frequently:</p> <ol style="list-style-type: none">1. Measure the grid voltage, and contact the local utility grid company for solutions if the grid voltage exceeds the specified value.2. Check, through the App, whether the protection parameters are appropriately set.3. Check whether the cross-sectional area of the AC cable meets the requirement.4. If the alarm persists, contact SUNGROW.
002	Grid undervoltage	<p>Generally, the inverter will be reconnected to the grid after the grid recovers. If the alarm occurs frequently:</p> <ol style="list-style-type: none">1. Measure the grid voltage, and contact the local utility grid company for solutions if the grid voltage is below the specified value.2. Check, through the App, whether the protection parameters are appropriately set.3. Check whether the AC cable is firmly in place.4. If the alarm persists, contact SUNGROW.

Alarm ID	Alarm Name	Corrective Measures
003	Grid overfrequency	<p>Generally, the inverter will be reconnected to the grid after the grid recovers. If the alarm occurs frequently:</p> <ol style="list-style-type: none"> 1. Measure the grid frequency, and contact the local utility grid company for solutions if the grid frequency is beyond the specified range.
004	Grid underfrequency	<ol style="list-style-type: none"> 2. Check, through the App, whether the protection parameters are appropriately set. 3. If the alarm persists, contact SUNGROW.
005	No Grid	<p>Generally, the inverter will be reconnected to the grid after the grid recovers. If the alarm occurs frequently:</p> <ol style="list-style-type: none"> 1. Check whether the grid supplies power reliably. 2. Check whether the AC cable is firmly in place. 3. Check whether the AC cable is correctly connected (whether the live wire and the N wire are in correct place). 4. Check whether the AC switch or circuit breaker is disconnected. 5. If the alarm persists, contact SUNGROW.
006	Overhigh leakage current	<ol style="list-style-type: none"> 1. The alarm can be caused by poor sunlight or damp environment, and the inverter will be reconnected to the grid after the environment is improved. 2. If the environment is normal, check whether the AC and DC cables are well insulated. 3. If the alarm persists, contact SUNGROW.
007	Grid abnormal	<p>Generally, the inverter will be reconnected to the grid after the grid recovers. If the alarm occurs frequently:</p> <ol style="list-style-type: none"> 1. Measure the grid frequency, and contact the local utility grid company for solutions if the grid frequency exceeds the specified value. 2. If the alarm persists, contact SUNGROW.

Alarm ID	Alarm Name	Corrective Measures
008	Grid voltage unbalance	<p>Generally, the inverter will be reconnected to the grid after the grid recovers. If the alarm occurs frequently:</p> <ol style="list-style-type: none"> 1. Measure the grid voltage. If the grid phase voltage differs greatly, contact the utility grid company for solutions. 2. If the voltage difference between the three phases is within the permissible range of the local utility grid company, modify the parameter setting through the App. 3. If the alarm persists, contact SUNGROW.
009	PV reverse connection fault	<ol style="list-style-type: none"> 1. Check whether the corresponding string is of reverse polarity. If so, disconnect the DC switch and adjust the polarity when the solar radiation is low and the string current drops below 0.5 A. 2. Check whether PV strings connected to the same MPPT have the same number of PV modules. If not, take corrective measures. 3. If the alarm persists, contact SUNGROW.
012	High ambient temperature	<ol style="list-style-type: none"> 1. Check whether the inverter is directly exposed to sunlight. If so, take some shading measures. 2. Check and clean the air ducts. 3. Check whether the sub-alarm ID 070 (fan alarm) occurs through the App. If so, replace the faulty fan. 4. If the alarm persists, contact SUNGROW.
013	Low ambient temperature	<ol style="list-style-type: none"> 1. Stop and disconnect the inverter. 2. Restart the inverter when the ambient temperature is within the permissible range.

Alarm ID	Alarm Name	Corrective Measures
014	Low ISO resistance	<p>Wait for the inverter to recover. If the fault occurs frequently:</p> <ol style="list-style-type: none"> 1. Check whether the insulation resistance protection value is extremely large through the App, and ensure that it complies with the local regulations. 2. Check the resistance to ground from the PV module/cable. Take corrective measures in case of leading to short circuit or damaged insulation layer. 3. If the cable is normal and the alarm occurs on rainy days, check it again when the weather turns fine. 4. If the fault occurs on a cloudy day without rain but there is stagnant water or vegetation on site, clear the water and vegetation. If the fault persists, check it again when the weather turns fine. 5. If the alarm persists, contact SUNGROW.
015	Grounding cable fault	<ol style="list-style-type: none"> 1. Check whether the AC cable is correctly connected. 2. Check whether the grounding cable and wire cores are wrongly insulated. 3. If the alarm persists, contact SUNGROW.
016	Arc fault	<ol style="list-style-type: none"> 1. Disconnect the DC inputs and check whether the DC cables are damaged, whether the wiring terminals or fuses, if necessary, are loose or in poor contact, and whether there is a PV module burnt. If so, take corresponding corrective measures. 2. After taking corresponding measures in step 1, reconnect the DC inputs. Remove the arc fault through the App, and therefore the inverter will recover. 3. If the alarm persists, contact SUNGROW.

Alarm ID	Alarm Name	Corrective Measures
019	Smart Energy Meter communication error	<ol style="list-style-type: none"> 1. Check whether the Smart Energy Meter communication cable and terminal are abnormal. If so, remove the corresponding abnormality. 2. Reconnect the Smart Energy Meter communication cable. 3. If the alarm persists, contact SUNGROW.
063	System alarm	<p>The inverter can operate normally.</p> <ol style="list-style-type: none"> 1. Check whether the related cable connection and terminals are abnormal, and check whether the ambient environment is abnormal. If so, take corrective measures. 2. If the alarm persists, contact SUNGROW.
064	System fault	<ol style="list-style-type: none"> 1. Wait for the inverter to recover. 2. Disconnect the AC and DC switches or circuit breakers, and connect them again after 15 minutes. 3. If the alarm persists, contact SUNGROW.

9.2 Maintenance

9.2.1 Maintenance Notices

The DC switch can be secured with a lock in the OFF position or a certain angle beyond the OFF position.

DANGER

Risk of inverter damage or personal injury due to incorrect service!

- Always keep in mind that the inverter is powered by dual sources: PV strings and utility grid.

Before any service work, observe the following procedure.

- Disconnect the AC circuit breaker and then set the DC load-break switch of the inverter to OFF;
- Wait at least 10 minutes for inner capacitors to discharge completely;
- Verify that there is no voltage or current before pulling any connector.

CAUTION

Keep non-related persons away!

A temporary warning sign or barrier must be posted to keep non-related persons away while performing electrical connection and service work.

NOTICE

Restart the inverter only after removing the fault that impairs safety performance.

As the inverter contains no component parts that can be maintained, never arbitrarily replace any internal components.

For any maintenance need, please contact SUNGROW. Otherwise, SUNGROW shall not be held liable for any damage caused.



Servicing of the device in accordance with the manual should never be undertaken in the absence of proper tools, test equipments or the latest revision of the manual which has been clearly and thoroughly understood.

9.2.2 Routine Maintenance

Item	Method	Period
System clean	Check the temperature and dust of the inverter. Clean the inverter enclosure if necessary.	Six months to a year (depending on the dust contents in air)

9.2.3 Fan Maintenance

If the inverter has an external fan, when the fan fails to work normally, the inverter cannot be effectively cooled, which will affect the efficiency of the inverter or cause derated operation. Therefore, keep the fan clean and replace the damaged fan in time.

Step 1 Refer to "[8.1 Disconnecting the Inverter](#)" to stop the inverter.

Step 2 Refer to "[5 Electrical Connection](#)" and disconnect all the cable connections in reverse steps.

Step 3 Refer to "[4 Mechanical Mounting](#)" and dismantle the inverter in reverse steps.

Step 4 Unscrew the screws on the fan bracket.

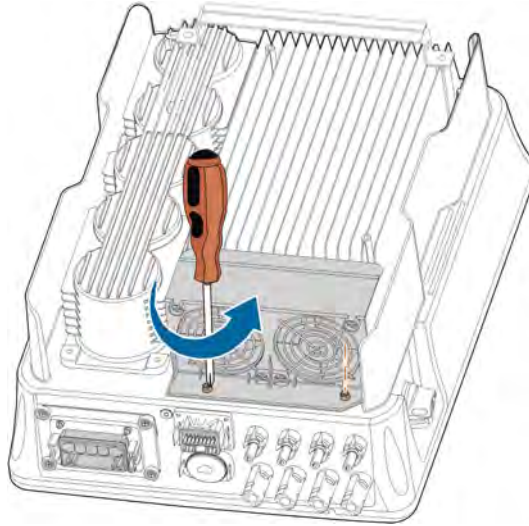

Step 5 Lift the fan bracket upwards, press down the protrusion on the fan power plug connector and pull it outwards, and remove the fan bracket.

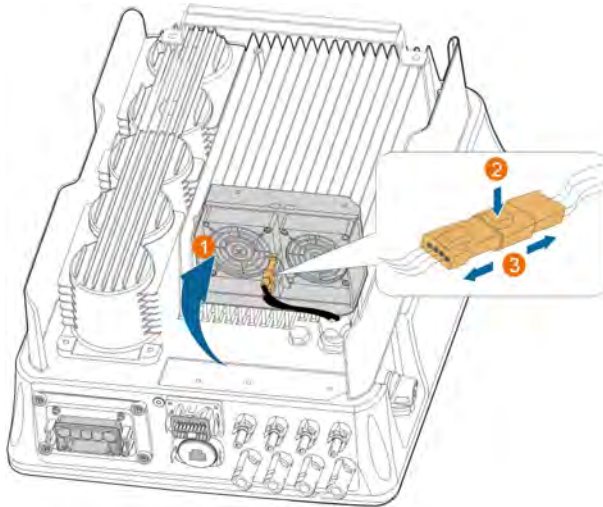

Step 6 Unscrew the screws on the dust covers and remove the dust covers.

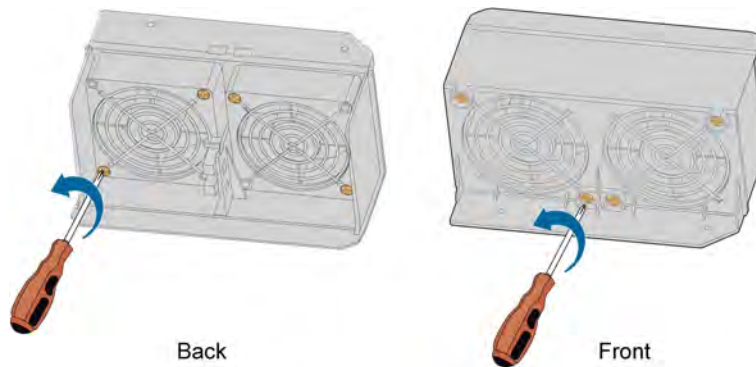

Step 7 Use a soft brush or vacuum cleaner to clean the fan. If you need to replace the fan, use a screwdriver to unscrew the screw at the fan bracket and remove the fan.

Step 8 Install the dust covers and then the fan bracket to the inverter. Restart the inverter.

-- End

10 Appendix

10.1 Technical Data

Parameter	SG3.0RT	SG4.0RT
Input (DC)		
Max. PV input power	4500 W	6000 W
Max. PV input voltage	1100 V *	
Startup voltage	180 V	
Nominal input voltage	600 V	
MPP voltage range	160 V – 1000 V	
No. of MPPTs	2	
Max. number of PV strings per MPPT	1 / 1	
Max. PV input current	25 A (12.5 A / 12.5 A)	
Max. current for input connector	30 A	
Max.DC Short-circuit current	32 A (16 A / 16 A)	
Max. inverter backfeed current to strings	0 A	
Output (AC)		
Nominal AC output power	3000 W	4000 W
Max. AC output apparent power	3000 VA for "AU", "BE", "DE", 3300 VA for others	4000 VA for "AU", "BE", "DE", 4400 VA for others
Max. AC output current	4.6 A for "AU", "BE", "DE", 5.1 A for others	6.1 A for "AU", "BE", "DE", 6.8 A for others
Max. inrush current (peak/duration)	20 A / 5 ms	
Max. output fault current (peak/duration)	40 A / 5 us	
Nominal AC voltage	3 / N / PE, 220 V / 230 V / 240 V	
AC voltage range	180 V AC – 276 V AC (this may vary with grid standards)	
Nominal grid frequency	50 Hz / 60 Hz	
Grid frequency range	45 Hz – 55 Hz / 55 Hz – 65 Hz (this may vary with grid standards)	

Parameter	SG3.0RT	SG4.0RT
Total Harmonic Distortion (THD)	< 5 % (of nominal power)	
Power factor	> 0.99 at default value at nominal power (adj. 0.8 overexcited/leading – 0.8 underexcited/lagging)	
Feed-in phases / connection phases	3 / 3	
Protection		
Grid monitoring	Yes	
DC reverse connection protection	Yes	
AC short circuit protection	Yes	
Leakage current protection	Yes	
DC switch	Yes	
PID recovery function	Yes	
Surge protection	DC Type II, AC Type II	
Overvoltage category	III [AC], II [PV]	
System Data		
Max. efficiency	98.20 %	
European efficiency	96.50 %	97.00 %
Isolation protection	Transformerless	
Ingress protection (IP) rating	IP65	
Operating ambient temperature range	-25°C to +60°C	
Allowable relative humidity range	0 – 100 %	
Max. operating altitude	4000 m (> 2000 m derating)	
Cooling method	Natural cooling	
Noise emission	< 35 dB	
Display	LED	
Communication	WLAN, Ethernet, RS485, DI, DO	
DC connection type	MC4	
AC connection type	Plug and play	
Mechanical Data		
Dimensions (W x H x D)	370 mm x 480 mm x 195 mm	
Mounting method	Wall-mounting bracket	
Weight	18 kg	

* The inverter enters standby state when the input voltage ranges between 1,000 V and 1,100 V. If the maximum DC voltage in the system can exceed 1,000 V, the MC4 connectors included in the scope of delivery must not be used. In this case MC4-Evo2 connectors must be used.

Parameter	SG5.0RT	SG6.0RT
Input (DC)		
Max. PV input power	7500 W	9000 W
Max. PV input voltage	1100 V *	
Startup voltage	180 V	
Nominal input voltage	600 V	
MPP voltage range	160 V – 1000 V	
No. of MPPTs	2	
Max. number of PV strings per MPPT	1 / 1	
Max. PV input current	25 A (12.5 A / 12.5 A)	
Max. current for input connector	30 A	
Max.DC Short-circuit current	32 A (16 A / 16 A)	
Max. inverter backfeed current to strings	0 A	
Output (AC)		
Nominal AC output power	5000 W	6000 W
Max. AC output apparent power	5000 VA for "AU", "BE", "DE", 5500 VA for others	6000 VA for "AU", "BE", "DE", 6600 VA for others
Max. AC output current	7.6 A for "AU", "BE", "DE", 8.3 A for others	9.1 A for "AU", "BE", "DE", 10.0 A for others
Max. inrush current (peak/duration)	20 A / 5 ms	
Max. output fault current (peak/duration)	40 A / 5 us	
Nominal AC voltage	3 / N / PE, 220 V / 230 V / 240 V	
AC voltage range	180 V AC – 276 V AC (this may vary with grid standards)	
Nominal grid frequency	50 Hz / 60 Hz	
Grid frequency range	45 Hz – 55 Hz / 55 Hz – 65 Hz (this may vary with grid standards)	

Parameter	SG5.0RT	SG6.0RT
Total Harmonic Distortion (THD)	< 3 % (of nominal power)	
Power factor	> 0.99 at default value at nominal power (adj. 0.8 overexcited/leading – 0.8 underexcited/lagging)	
Feed-in phases / connection phases	3 / 3	
Protection		
Grid monitoring	Yes	
DC reverse connection protection	Yes	
AC short circuit protection	Yes	
Leakage current protection	Yes	
DC switch	Yes	
PID recovery function	Yes	
Surge protection	DC Type II, AC Type II	
Overvoltage category	III [AC], II [PV]	
System Data		
Max. efficiency	98.40 %	
European efficiency	97.40 %	
Isolation protection	Transformerless	
Ingress protection (IP) rating	IP65	
Operating ambient temperature range	-25°C to +60°C	
Allowable relative humidity range	0 – 100 %	
Max. operating altitude	4000 m (> 2000 m derating)	
Cooling method	Natural cooling	
Noise emission	< 35 dB	
Display	LED	
Communication	WLAN, Ethernet, RS485, DI, DO	
DC connection type	MC4	
AC connection type	Plug and play	
Mechanical Data		
Dimensions (W x H x D)	370 mm x 480 mm x 195 mm	
Mounting method	Wall-mounting bracket	
Weight	18 kg	

* The inverter enters standby state when the input voltage ranges between 1,000 V and 1,100 V. If the maximum DC voltage in the system can exceed 1,000 V, the MC4 connectors included in the scope of delivery must not be used. In this case MC4-Evo2 connectors must be used.

Parameter	SG7.0RT	SG8.0RT
Input (DC)		
Max. PV input power	10500 W	12000 W
Max. PV input voltage	1100 V *	
Startup voltage	180 V	
Nominal input voltage	600 V	
MPP voltage range	160 V – 1000 V	
No. of MPPTs	2	
Max. number of PV strings per MPPT	2 / 1	
Max. PV input current	37.5 A (25 A / 12.5 A)	
Max. current for input connector	30 A	
Max. DC short-circuit current	48 A (32 A / 16 A)	
Max. inverter backfeed current to strings	0 A	
Output (AC)		
Nominal AC output power	6999 W for "AU", 7000 W for others	8000 W
Max. AC output apparent power	6999 VA for "AU", 7000 VA for "BE", "DE", 7700 VA for others	8000 VA for "AU", "BE", "DE", 8800 VA for others
Max. AC output current	10.6 A for "AU", 10.7 A for "BE", "DE", 11.7 A for others	12.1 A for "AU", "BE", "DE", 13.3 A for others
Max. inrush current (peak/duration)	20 A / 5 ms	
Max. output fault current (peak/duration)	40 A / 5 us	
Nominal AC voltage	3 / N / PE, 220 V / 230 V / 240 V	
AC voltage range	180 V AC – 276 V AC (this may vary with grid standards)	
Nominal grid frequency	50 Hz / 60 Hz	

Parameter	SG7.0RT	SG8.0RT
Grid frequency range	45 Hz – 55 Hz / 55 Hz – 65 Hz (this may vary with grid standards)	
Total Harmonic Distortion (THD)	< 3 % (of nominal power)	
Power factor	> 0.99 at default value at nominal power (adj. 0.8 overexcited/leading – 0.8 underexcited/lagging)	
Feed-in phases / connection phases	3 / 3	
Protection		
Grid monitoring	Yes	
DC reverse connection protection	Yes	
AC short circuit protection	Yes	
Leakage current protection	Yes	
DC switch	Yes	
PID recovery function	Yes	
Surge protection	DC Type II, AC Type II	
Overvoltage category	III [AC], II [PV]	
System Data		
Max. efficiency	98.40 %	98.50 %
European efficiency	97.70 %	97.80 %
Isolation protection	Transformerless	
Ingress protection (IP) rating	IP65	
Operating ambient temperature range	-25°C to +60°C	
Allowable relative humidity range	0 – 100 %	
Max. operating altitude	4000 m (> 2000 m derating)	
Cooling method	Natural cooling	
Noise emission	< 35 dB	
Display	LED	
Communication	WLAN, Ethernet, RS485, DI, DO	
DC connection type	MC4	
AC connection type	Plug and play	
Mechanical Data		
Dimensions (W x H x D)	370 mm x 480 mm x 195 mm	

Parameter	SG7.0RT	SG8.0RT
Mounting method	Wall-mounting bracket	
Weight	18 kg	

* The inverter enters standby state when the input voltage ranges between 1,000 V and 1,100 V. If the maximum DC voltage in the system can exceed 1,000 V, the MC4 connectors included in the scope of delivery must not be used. In this case MC4-Evo2 connectors must be used.

Parameter	SG10RT	SG12RT
Input (DC)		
Max. PV input power	15000 W	18000 W
Max. PV input voltage	1100 V *	
Startup voltage	180 V	
Nominal input voltage	600 V	
MPP voltage range	160 V – 1000 V	
No. of MPPTs	2	
Max. number of PV strings per MPPT	2 / 1	
Max. PV input current	37.5 A (25 A / 12.5 A)	
Max. current for input connector	30 A	
Max. DC short-circuit current	48 A (32 A / 16 A)	
Max. inverter backfeed current to strings	0 A	
Output (AC)		
Nominal AC output power	10000 W	12000 W
Max. AC output apparent power	10000 VA for "AU", "BE", "DE", 11000 VA for others	12000 VA for "AU", "BE", "DE", 13200 VA for others
Max. AC output current	15.2 A for "AU", "BE", "DE", 16.7 A for others	18.2 A for "AU", "BE", "DE", 20.0 A for others
Max. inrush current (peak/duration)	20 A / 5 ms	
Max. output fault current (peak/duration)	40 A / 5 us	
Nominal AC voltage	3 / N / PE, 220 V / 230 V / 240 V	
AC voltage range	180 V AC – 276 V AC (this may vary with grid standards)	
Nominal grid frequency	50 Hz / 60 Hz	

Parameter	SG10RT	SG12RT
Grid frequency range	45 Hz – 55 Hz / 55 Hz – 65 Hz (this may vary with grid standards)	
Total Harmonic Distortion (THD)	< 3 % (of nominal power)	
Power factor	> 0.99 at default value at nominal power (adj. 0.8 overexcited/leading – 0.8 underexcited/lagging)	
Feed-in phases / connection phases	3 / 3	
Protection		
Grid monitoring	Yes	
DC reverse connection protection	Yes	
AC short circuit protection	Yes	
Leakage current protection	Yes	
DC switch	Yes	
PID recovery function	Yes	
Surge protection	DC Type II, AC Type II	
Overvoltage category	III [AC], II [PV]	
System Data		
Max. efficiency	98.50 %	
European efficiency	97.90 %	
Isolation protection	Transformerless	
Ingress protection (IP) rating	IP65	
Operating ambient temperature range	-25°C to +60°C	
Allowable relative humidity range	0 – 100 %	
Max. operating altitude	4000 m (> 2000 m derating)	
Cooling method	Natural cooling	
Noise emission	< 35 dB	
Display	LED	
Communication	WLAN, Ethernet, RS485, DI, DO	
DC connection type	MC4	
AC connection type	Plug and play	
Mechanical Data		
Dimensions (W x H x D)	370 mm x 480 mm x 195 mm	

Parameter	SG10RT	SG12RT
Mounting method	Wall-mounting bracket	
Weight	18 kg	

* The inverter enters standby state when the input voltage ranges between 1,000 V and 1,100 V. If the maximum DC voltage in the system can exceed 1,000 V, the MC4 connectors included in the scope of delivery must not be used. In this case MC4-Evo2 connectors must be used.

Parameter	SG15RT	SG17RT	SG20RT
Input (DC)			
Max. PV input power	22500 W	25500 W	30000 W
Max. PV input voltage	1100 V *		
Startup voltage	180 V		
Nominal input voltage	600 V		
MPP voltage range	160 V – 1000 V		
No. of MPPTs	2		
Max. number of PV strings per MPPT	2 / 2		
Max. PV input current	50 A (25 A / 25 A)		
Max. current for input connector	30 A		
Max. DC short-circuit current	64 A (32 A / 32 A)		
Max. inverter backfeed current to strings	0 A		
Output (AC)			
Nominal AC output power	15000 W	17000 W	20000 W
Max. AC output apparent power	15000 VA for "AU", "BE", "DE", 16500 VA for others	17000 VA for "AU", "BE", "DE", 18700 VA for others	20000 VA for "AU", "BE", "DE", 22000 VA for others
Max. AC output current	22.7 A for "AU", "BE", "DE", 25.0 A for others	25.8 A for "AU", "BE", "DE", 28.3 A for others	30.3 A for "AU", "BE", "DE", 31.9 A for others
Max. inrush current (peak/duration)	20 A / 5 ms		
Max. output fault current (peak/duration)	100 A / 5 us		
Nominal AC voltage	3 / N / PE, 220 V / 230 V / 240 V		

Parameter	SG15RT	SG17RT	SG20RT
AC voltage range	180 V AC – 276 V AC (this may vary with grid standards)		
Nominal grid frequency	50 Hz / 60 Hz		
Grid frequency range	45 Hz – 55 Hz / 55 Hz – 65 Hz (this may vary with grid standards)		
Total Harmonic Distortion (THD)	< 3 % (of nominal power)		
Power factor	> 0.99 at default value at nominal power (adj. 0.8 overexcited/leading – 0.8 underexcited/lagging)		
Feed-in phases / connection phases	3 / 3		
Protection			
Grid monitoring	Yes		
DC reverse connection protection	Yes		
AC short circuit protection	Yes		
Leakage current protection	Yes		
DC switch	Yes		
PID recovery function	Yes		
Surge protection	DC Type II, AC Type II		
Overvoltage category	III [AC], II [PV]		
System Data			
Max. efficiency	98.50 %		
European efficiency	98.10 %		
Isolation protection	Transformerless		
Ingress protection (IP) rating	IP65		
Operating ambient temperature range	-25°C to +60°C		
Allowable relative humidity range	0 – 100 %		
Max. operating altitude	4000 m (> 2000 m derating)		
Cooling method	Smart forced air cooling		
Noise emission	< 45 dB		
Display	LED		
Communication	WLAN, Ethernet, RS485, DI, DO		
DC connection type	MC4		

Parameter	SG15RT	SG17RT	SG20RT
AC connection type	Plug and play		
Mechanical Data			
Dimensions (W x H x D)	370 mm x 480 mm x 195 mm		
Mounting method	Wall-mounting bracket		
Weight	21 kg		

* The inverter enters standby state when the input voltage ranges between 1,000 V and 1,100 V. If the maximum DC voltage in the system can exceed 1,000 V, the MC4 connectors included in the scope of delivery must not be used. In this case MC4-Evo2 connectors must be used.

10.2 Quality Assurance

When product faults occur during the warranty period, SUNGROW will provide free service or replace the product with a new one.

Evidence

During the warranty period, the customer shall provide the product purchase invoice and date. In addition, the trademark on the product shall be undamaged and legible. Otherwise, SUNGROW has the right to refuse to honor the quality guarantee.

Conditions

- After replacement, unqualified products shall be processed by SUNGROW.
- The customer shall give SUNGROW a reasonable period to repair the faulty device.

Exclusion of Liability

In the following circumstances, SUNGROW has the right to refuse to honor the quality guarantee:

- The free warranty period for the whole machine/components has expired.
- The device is damaged during transport.
- The device is incorrectly installed, refitted, or used.
- The device operates in harsh environment, as described in this manual.
- The fault or damage is caused by installation, repairs, modification, or disassembly performed by a service provider or personnel not from SUNGROW.
- The fault or damage is caused by the use of non-standard or non-SUNGROW components or software.
- The installation and use range are beyond stipulations of relevant international standards.
- The damage is caused by unexpected natural factors.

For faulty products in any of above cases, if the customer requests maintenance, paid maintenance service may be provided based on the judgment of SUNGROW.

10.3 Contact Information

Should you have any question about this product, please contact us.
We need the following information to provide you the best assistance:

- Model of the device
- Serial number of the device
- Fault code/name
- Brief description of the problem

China (HQ)

Sungrow Power Supply Co., Ltd
Hefei
+86 551 65327834
service@sungrowpower.com

Australia

Sungrow Australia Group Pty. Ltd.
Sydney
+61 2 9922 1522
service@sungrowpower.com.au

Brazil

Sungrow Do Brasil
Sao Paulo
+55 0800 677 6000
latam.service@sungrowamericas.com

France

Sungrow France
Lyon
+33420102107
service@sungrow-emea.com

Germany, Austria, Switzerland

Sungrow Deutschland GmbH
Munich
+49 0800 4327 9289
service@sungrow-emea.com

Greece

Service Partner – Survey Digital
+30 2106044212
service@sungrow-emea.com

India

Sungrow (India) Private Limited
Gurgaon
+91 080 41201350
service@in.sungrowpower.com

Italy

Sungrow Italy
Verona
+39 0800 974739 (Residential)
+39 045 4752117 (Others)
service@sungrow-emea.com

Japan

Sungrow Japan K.K.
Tokyo
+ 81 3 6262 9917
service@jp.sungrowpower.com

Korea

Sungrow Power Korea Limited
Seoul
+82 70 7719 1889
service@kr.sungrowpower.com

<p>Malaysia</p> <p>Sungrow SEA Selangor Darul Ehsan +60 19 897 3360 service@my.sungrowpower.com</p>	<p>Philippines</p> <p>Sungrow Power Supply Co., Ltd Mandaluyong City +63 91 73022769 service@ph.sungrowpower.com</p>
<p>Thailand</p> <p>Sungrow Thailand Co., Ltd. Bangkok +66 891 246053 service@th.sungrowpower.com</p>	<p>Spain</p> <p>Sungrow Ib é rica S.A.U. Mutilva +34 948 05 22 04 service@sungrow-emea.com</p>
<p>Romania</p> <p>Service Partner - Elerex +40 241 762250 service@sungrow-emea.com</p>	<p>Turkey</p> <p>Sungrow Deutschland GmbH Turkey Istanbul +90 216 663 61 80 service@sungrow-emea.com</p>
<p>UK</p> <p>Sungrow Power UK Ltd. Milton Keynes +44 (0) 01908 414127 service@sungrow-emea.com</p>	<p>U.S.A, Mexico</p> <p>Sungrow USA Corporation Phoenix +1 833 747 6937 techsupport@sungrow-na.com</p>
<p>Vietnam</p> <p>Sungrow Vietnam Hanoi +84 918 402 140 service@vn.sungrowpower.com</p>	<p>Belgium, Netherlands and Luxembourg (Benelus)</p> <p>+31 08000227012 (only for Netherlands) service@sungrow-emea.com</p>
<p>Poland</p> <p>+48 221530484 service@sungrow-emea.com</p>	-

Clean power for all

SUNGROW

Sungrow Power Supply Co., Ltd.

Add: No.1699 Xiyou Rd.,New & High Technology Industrial Development Zone, 230088,Hefei, P. R. China.

Web: www.sungrowpower.com

Specifications are subject to changes without advance notice.