



**PYLONTECH**



# Rechargeable Li-ion Battery

## US3000C Operation Manual

Information Version: V1.0









**5PMPA08-00222**





This manual introduces US3000C from Pylontech. Please read this manual before you to install the battery and follow the instruction carefully during the installation process. Any confusion, please contact Pylontech immediately for advice and clarification.

<b>1. Symbols in label, manual and product</b>	<b>1</b>
<b>2. Safety Precautions</b>	<b>2</b>
2.1 Before Connecting	3
2.2 In Using	3
<b>3. Introduction</b>	<b>4</b>
3.1 Features	4
3.2 Specification	6
3.3 Equipment interface instruction	8
Definition of RJ45 Port Pin	10
<b>4. Safe handling of lithium batteries guide</b>	<b>12</b>
4.1 Schematic diagram of solution	12
4.2 Danger label	12
4.3 Tools	13
4.4 Safety gear	13
<b>5. Installation and operation</b>	<b>14</b>
5.1 Package items	14
5.2 Installation location	16
5.3 Grounding	17
5.4 Put into cabinet or racks	18
5.5 Put into bracket	20
5.6 Suitable breaker	23
5.7 Power on	23
5.8 Power off	25
5.9 Multi-group mode	26
<b>6. Trouble shooting</b>	<b>28</b>
<b>7. Emergency Situations</b>	<b>31</b>
<b>8. Remarks</b>	<b>32</b>

## 1. Symbols in label, manual and product

	Caution! Warning! Reminding. Safety related information. Risk of battery system failure or life cycle reduces.
	Do not reverse connection the positive and negative.
	Do not place near open flame
	Do not place at the children and pet touchable area.
	Warning electric shock.
	Warning Fire. Do not place near flammable material
	Read the product and operation manual before operating the battery system!
	Grounding.
	Recycle label.

	<p>The certificate label for EMC.</p>
	<p>Label for Waste Electrical and Electronic Equipment (WEEE) Directive (2012/19/EU)</p>
	<p>The certificate label for Safety by TÜV Rheinland.</p>

## 2. Safety Precautions



### Reminding

- 1) It is important and necessary to read the user manual carefully (in the accessories) before installing or using battery. Failure to do so or to follow any of the instructions or warnings in this document can result in electrical shock, serious injury, or death, or can damage battery, potentially rendering it inoperable
- 2) If the battery is stored for long time, it is required to charge them every six months, and the SOC should be no less than 90%
- 3) Battery needs to be recharged within 12 hours, after fully discharged
- 4) Do not install the product in outdoor environment, or an environment out of the operation temperature or humidity range listed in manual.
- 5) Do not expose cable outside
- 6) Do not connect power terminal reversely.
- 7) All the battery terminals must be disconnected for maintenance
- 8) Please contact the supplier within 24 hours if there is something abnormal.
- 9) Do not use cleaning solvents to clean battery
- 10) Do not expose battery to flammable or harsh chemicals or vapors
- 11) Do not paint any part of battery, include any internal or external components

- 12) Do not connect battery with PV solar wiring directly
- 13) The warranty claims are excluded for direct or indirect damage due to items above.
- 14) Any foreign object is prohibited to insert into any part of battery



## **Warning**

### **2.1 Before Connecting**

- 1) After unpacking, please check product and packing list first, if product is damaged or lack of parts, please contact with the local retailer
- 2) Before installation, be sure to cut off the grid power and make sure the battery is in the turned-off mode
- 3) Wiring must be correct, do not mistake the positive and negative cables, and ensure no short circuit with the external device
- 4) It is prohibited to connect the battery and AC power directly
- 5) The embedded BMS in the battery is designed for 48VDC, please DO NOT connect battery in series
- 6) Battery must connect to ground and the resistance must be less than 0.1Ω
- 7) Please ensured the electrical parameters of battery system are compatible to related equipment
- 8) Keep the battery away from water and fire.

### **2.2 In Using**

- 1) If the battery system needs to be moved or repaired, the power must be cut off and the battery is completely shutdown
- 2) It is prohibited to connect the battery with different type of battery.
- 3) It is prohibited to connect batteries with faulty or incompatible inverter
- 4) It is prohibited to disassemble the battery (QC tab removed or damaged);
- 5) In case of fire, only dry powder fire extinguisher can be used, liquid fire

extinguishers are prohibited

- 6) Please do not open, repair or disassemble the battery except staffs from Pylontech or authorized by Pylontech. We do not undertake any consequences or related responsibility which because of violation of safety operation or violating of design, production and equipment safety standards.

### **3. Introduction**

US3000C lithium iron phosphate battery is the new energy storage products developed and produced by Pylontech, it can be used to provide reliable power for various types of equipment and systems.

US3000C has built-in BMS battery management system, which can manage and monitor cells information including voltage, current and temperature.

#### **3.1 Features**

- 1) NEW: Build-in soft-start function able to reduce current strike when inverter need to start from battery.
- 2) NEW: Dual active protection on BMS level.
- 3) NEW: Automatic address setting when connect in multi-group.
- 4) NEW: Support wake up by 5~12V signal from RJ45 port.
- 5) NEW: Support upgrade battery module from upper controller via CAN or RS485 communication.
- 6) NEW: Enable 95% depth of discharge, available for the inverter which completely follow Pylontech latest protocol to operate.
- 7) The module is non-toxic, non-pollution and environmentally friendly
- 8) Cathode material is made from LiFePO<sub>4</sub> with safety performance and long cycle life
- 9) Battery management system (BMS) has protection functions including over-discharge, over-charge, over-current and high/low temperature
- 10) The system can automatically manage charge and discharge state and

balance voltage of each cell

- 11) Flexible configuration, multiple battery modules can be in parallel for expanding capacity and power
- 12) Adopted self-cooling mode rapidly reduced system entire noise
- 13) The module has less self-discharge, up to 6 months without charging it on shelf, no memory effect, excellent performance of shallow charge and discharge
- 14) Small size and light weight, standard of 19-inch embedded designed module is comfortable for installation and maintenance
- 15) Compatible with the US2000C, US3000, and US2000.

\*Mixture using master battery priority:

US3000C>US2000C>US3000>US2000

For same type of module always use the latest production unit as master.

\*Mixture using battery deployment option:

Master battery (1 <sup>st</sup> )	US3000C/US2000C
Slave 2 <sup>nd</sup> ~8 <sup>th</sup>	US3000C/US2000C/US3000/US2000
Slave 9 <sup>th</sup> ~16 <sup>th</sup>	US3000C/US2000C



### 3.2 Specifications

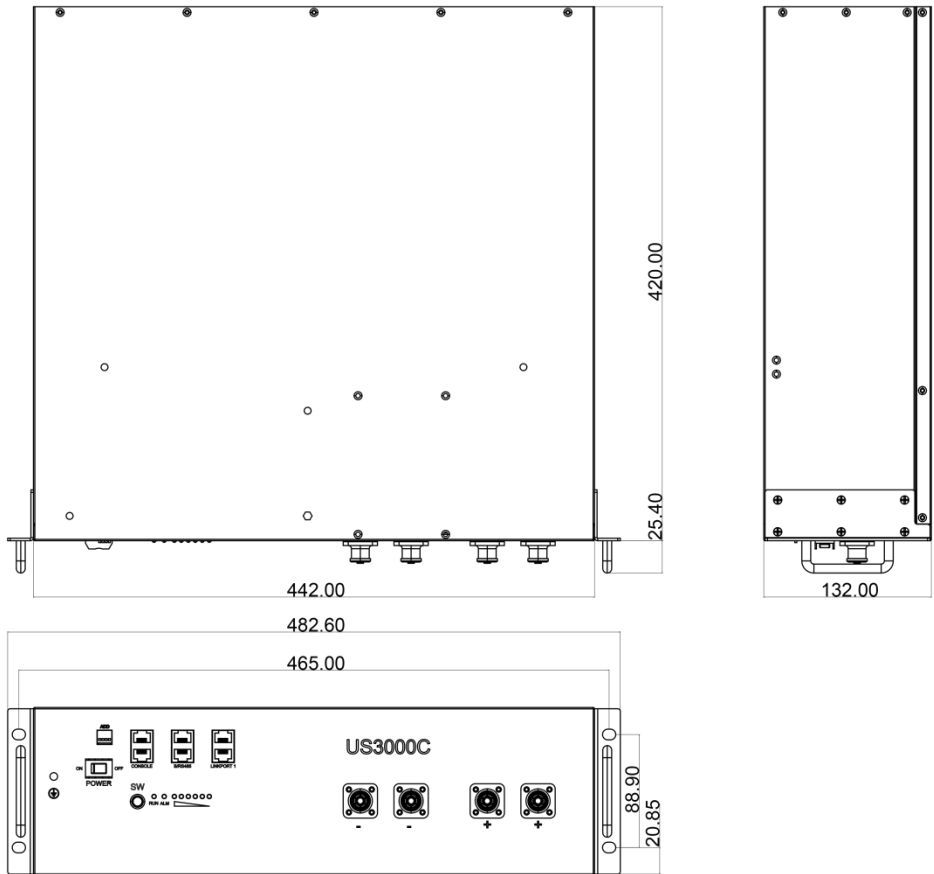

Basic Parameters	US3000C
Nominal Voltage (V)	48
Nominal Capacity (Wh)	3552
Usable Capacity (Wh)	3374.4
Dimension (mm)	442*420*132
Weight (Kg)	32
Discharge Voltage (V)	44.5 ~ 53.5
Charge Voltage (V)	52.5 ~ 53.5

Recommend Charge/Discharge Current (A)	37
Max. Charge/Discharge Current (A)	74-89@60sec
Peak Charge/Discharge Current (A)	90~200@15sec
Communication	RS485, CAN
Depth of discharge (%)	95
Configuration (max. in 1 battery group)	16pcs
Working Temperature (°C)	0~50 Charge
	-10~50Discharge
Shelf Temperature (°C)	-20~60
Short current/duration time	<4000A/2ms
Cooling type	Natural
Protective class	I
IP rating of enclosure	IP20
Humidity (% RH)	5 ~ 95 (No Condensation)
Altitude(m)	<4000
Certifications	TÜV / CE / UN38.3/UL
Design life (year)	15+ (25°C/77°F)
Cycle Life (cycle)*	>8,000 25°C
Reference to standards	IEC62619, IEC63056, IEC62040, IEC62477-1, UL1973,U1642,UL9540A, VDE2510-50, IEC61000-6-2, IEC61000-6-3, UN38.3

\* Cycle Life is defined based on specific operation conditions, for more details please check with Pylontech service team.

### 3.3 Equipment interface instruction

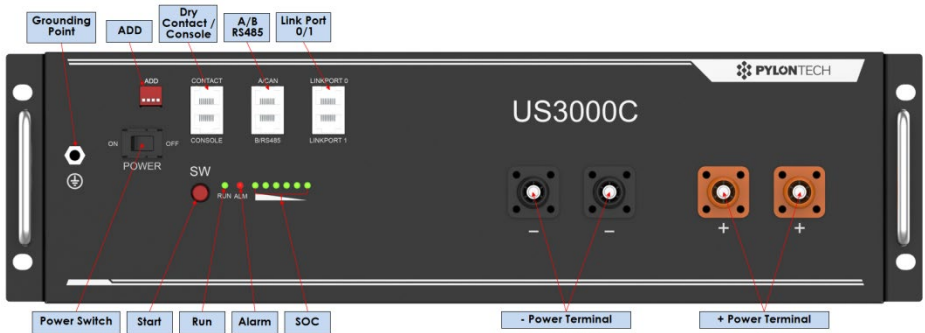

#### Power Switch

ON: ready to turn on.

OFF: power off. For storage or shipping.

#### Start

Turn on: press more than 0.5s to start the battery module

Turn off: press more than 0.5s to turn off the battery.

#### RUN

Green LED lighting to show the battery running status

#### Alarm

Red LED flashing to show the battery has alarm; lighting to show the battery is under protection.

#### SOC

6 green LEDs to show the battery's current capacity.

#### ADD Switch



Dip1: RS485 baud rate: 1: 9600; 0: 115200. After change, please restart battery.

Dip2: CAN terminal resistance on BMS side. 1: NONE. 0: connected. After change, no restart required. **In single group mode, please keep dip2 at 0 position.** For multi-groups, please refer to [5.9].

Dip3~4, reversed.

Based on design of BMS, the dip switch is deployed physically reversely.

For instance:

Dip1	Dip2	Dip3	Dip4	The corresponding position of switch	Status
0	0	0	0		RS485:115200 CAN terminal resistance: connected
1	0	0	0		RS485:9600 CAN terminal resistance: connected
0	1	0	0		RS485: 115200 CAN terminal resistance: NONE

## Console

For manufacturer or professional engineer to debug or service.

Pin3	232-TX
Pin4*	+5~+12V for wake up
Pin5*	GND for wake up
Pin6	232-RX
Pin8	232-GND
*Wake up signal shall $\geq 0.5$ Sec, current between 5~15mA. After send wake up signal, the voltage shall disappear for normal operation.	

## Contact

Pin1	Input, passive signal. On: turn off battery. Off: normal.	
Pin2		
Pin3	Output1. On: stop charge.	+
Pin4		-
Pin5	Output2. On: stop discharge.	+
Pin6		-
Pin7	Output3. On: BMS error.	+
Pin8		-

Output request signal voltage  $\leq 25V$

## CAN

500 Kbps. 120Ω. For connection to LV-HUB, inverter, or upper battery.

## RS485

9600 or 115200 bps.120Ω. For connection to inverter, or slave battery.

## Link Port 0, 1

for communication between multiple parallel batteries.

### Definition of RJ45 Port Pin

	A/CAN	B/RS485
Pin1	<b>These pins shall be NULL.</b>	
Pin2	<b>If not, may influence communication</b>	
Pin3	<b>between BMS and inverter.</b>	
Pin4	CAN-H	CAN-H (single group)
Pin5	CAH-L	CAN-L (single group)
Pin6	CAN-GND	CAN-GND (single group)
Pin7	485A	485A
Pin8	485B	485B

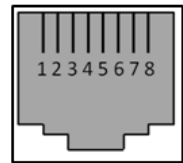

RJ45 Port

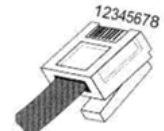

RJ45 Plug

## Power Terminals

Power cable terminals: there are two pair of terminals with same function, one connects to equipment, the other one paralleling to other battery module for capacity expanding.

For power cables uses water-proofed connectors. must keep pressing this Lock Button while pulling out the power plug.

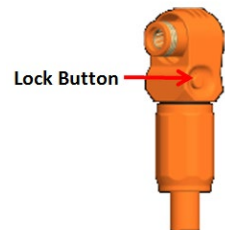

## LED Status Indicators

Condition	RUN	ALR	1	2	3	4	5	6
Power off	-	-	-	-	-	-	-	-
Power on								
Idle/Normal		-	-	-	-	-	-	-
Charge		-	Show soc; highest LED flash on: 0.5s; off 0.5s					
Discharge			Show soc					
Alarm	ALR: ; Other LEDs are same as above.							
System error/Protect	-		-	-	-	-	-	
	ON							
	flash, on: 0.3s; off: 3.7s							
	flash, on:0.5s; off: 1.5s							

## BMS basic function

Protection and alarm	Management and monitor
Charge/Discharge End	Cells Balance
Charge Over Voltage	Intelligent Charge Model
Discharge Under Voltage	Charge/Discharge Current Limit
Charge/Discharge Over Current	Capacity Retention Calculate
High/Low Temperature(cell/BMS)	Administrator Monitor
Short Circuit	Operation Record
	Power Cable Reverse
	Soft start of inverter

## 4. Safe handling of lithium batteries guide

### 4.1 Schematic diagram of solution

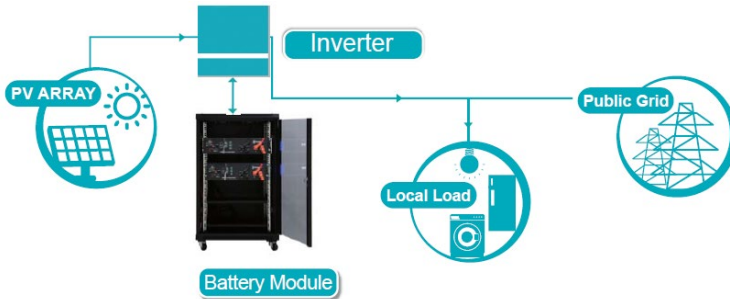

### 4.2 Danger label

**DANGER**  
DANGER LOW DC VOLTAGE INSIDE  
DANGER ARC FLASH & SHOCK HAZARD

A vertical column of seven warning icons: 1. A yellow triangle with a black exclamation mark. 2. A red circle with a diagonal slash over a flame. 3. A red circle with a diagonal slash over a child. 4. A yellow triangle with a black lightning bolt. 5. A yellow triangle with a black flame. 6. A yellow circle with a black silhouette of a person working. 7. A black battery symbol with a diagonal slash over it.

- \* Do not disconnect or disassemble by non-professional personnel.
- \* Do not drop, deform, impact, cut or spearing with a sharp object.
- \* Do not place at a children or pet touchable area.
- \* Do not place near open flame or flammable material.
- \* Do not cover or wrap the product case.
- \* Do not sit or put heavy things on battery.
- \* Do not touch the leaking liquid.
- \* Avoid of direct sunlight.
- \* Avoid of moisture or liquid.
- \* The product Ingress Protection (IP) class is IP20.
- \* Make sure the grounding connection set correctly before operation.
- \* Follow the product manual to make wiring connection.
- \* If leaking, fire, wet or damaged, switch off the breaker on DC side and stay away from battery.
- \* Contact your supplier within 24 hours if anything failure happens.

## 4.3 Tools



Wire cutter



Crimping modular plier



Screwdriver

### NOTE

Use properly insulated tools to prevent accidental electric shock or short circuits. If insulated tools are not available, cover the entire exposed metal surfaces of the available tools, except their tips, with electrical tape.

## 4.4 Safety gear

It is recommended to wear the following safety gear when dealing with the battery pack



Insulated gloves



Safety goggles



Safety shoes



## 5. Installation and operation

### 5.1 Package items

Unpacking and check the Packing List

#### 1) For battery module package:

- Battery Module



- Two 4AWG power cables and one RJ45 communication cable

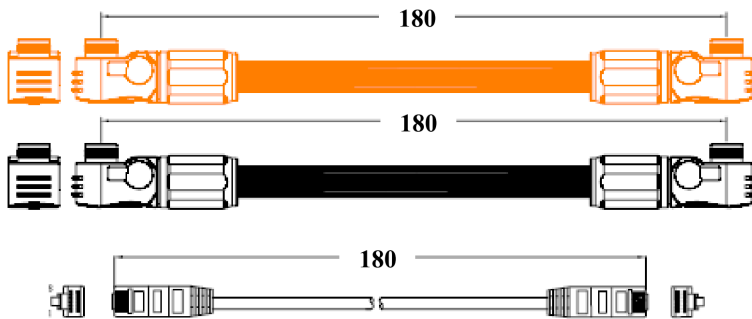

- 10AWG grounding cable

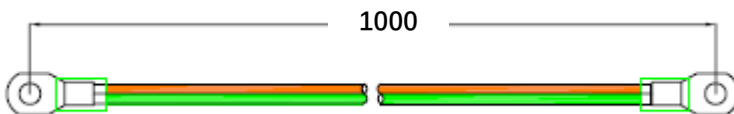

## 2) For External cable kits:

### NOTE

Power and communication cables to connect to inverter belongs to an **External Cable Kit, NOT include in battery carton box**. They are in another **extra small cable box**. If there is anything missed please contact dealer.

Two power cables (4 AWG, peak current capacity **120A**, constant **100A**) and communication cable for each energy storage system

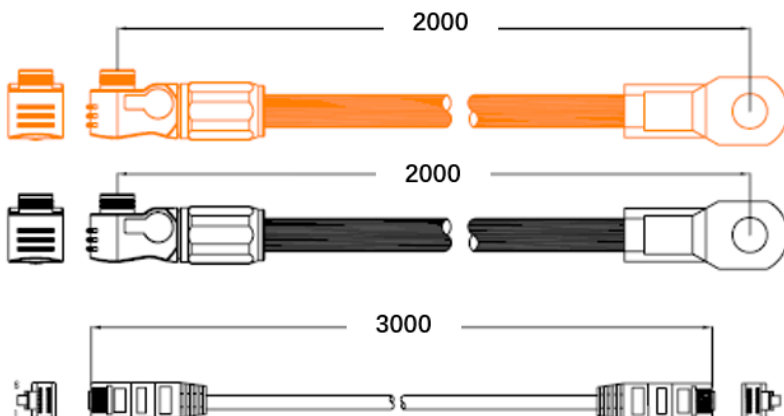

For the external cables, the length shall less than 3 meters.

SN of RJ45cable	Mark	Pin	
WI0SCAN30RJ1	With <b>blue</b> mark: Battery-Inverter	Pin1~3: NULL Pin4~8: pin to pin	For connection to inverter
WI0SCAN35RJ3	With silver mark: Battery-Battery	Pin1~8: pin to pin	For parallel connection between master batteries

## 5.2 Installation location

Make sure that the installation location meets the following conditions:

- 1) The area is completely waterproof
- 2) The floor is flat and level.
- 3) There are no flammable or explosive materials.
- 4) The ambient temperature is within the range from 0°C to 50°C.
- 5) The temperature and humidity are maintained at a constant level.
- 6) There is minimal dust and dirt in the area.
- 7) The distance from heat source is more than 2 meters.
- 8) The distance from air outlet of inverter is more than 0.5 meters.
- 9) The installation areas shall avoid of direct sunlight.
- 10) There are no mandatory ventilation requirements for battery module, but please avoid of installation in confined area. The aeration shall avoid of high salinity, humidity or temperature.



### **Caution**

If the ambient temperature is out of the operating range, the battery stops operating to protect itself. The optimal temperature range for the battery pack to operate is 10°C to 40°C. Frequent exposure to harsh temperatures may deteriorate the performance and life of the battery.

## 5.3 Grounding

Grounding cables shall be 10AWG or higher yellow-green cables. After connection, the resistance from battery grounding point to Ground connection point of room or installed place shall smaller than 0.1Ω.

- 1) based on metal directly touch between the module's surface and rack's surface. If using painted rack, the corresponding place shall remove the painting.
- 2) install a grounding cable to the grounding point of the modules.

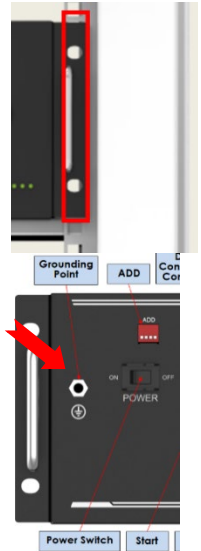

## 5.4 Put into cabinet or racks

Put battery modules into cabinet and connect the cables:



- 1) Put the battery into the cabinet
- 2) Drive the 4 pcs screws
- 3) Connect the cables between battery modules
- 4) Connect the cables to inverter

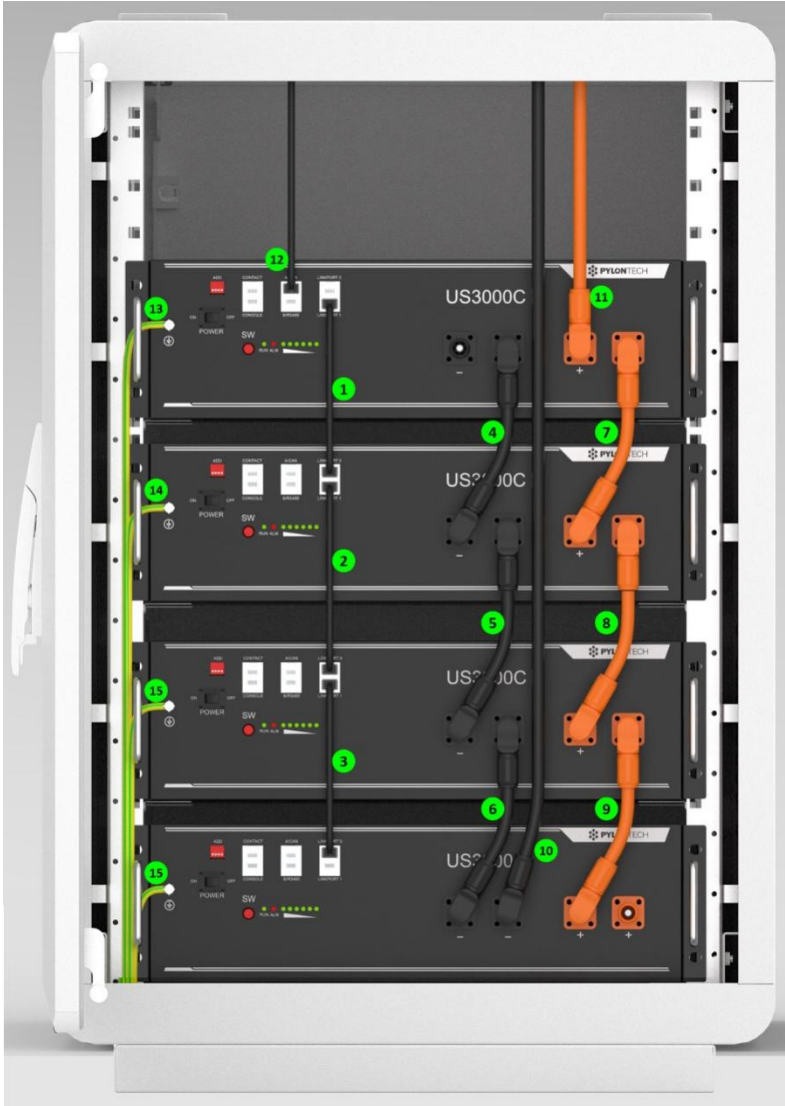

## 5.5 Put into bracket

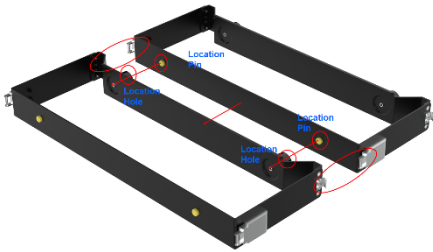

### 1) Dismantle the 2 holders of battery.

1. Dismantle the 2 tabs on the battery.



Dismantle 12 screws.

2) Put the battery into 2 pcs of bracket.

2. Set the battery into 2 pcs **Bracket** from front and back.



3) Use 4 location holes, stack the batteries together. And connect the 4 locker together.





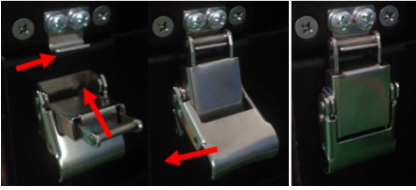

4) Maximum 4 in stack.



## NOTE

**After installation, do not forget to register online for full warranty:**

<http://www.pylontech.com.cn/service/support>



### Caution

- 1) Follow local electric safety and installation policies, a suitable breaker between battery system and inverter could be required.
- 2) All the installation and operation must follow local electric standards.

## 5.6 Suitable breaker

- 1) The rated voltage shall  $\geq 60V$  DC. Do **NOT** use AC breaker.
- 2) The type of breaker shall be type C (recommended) or type D.
- 3) The rated current shall match with system design:  
shall consider the DC current on inverter side.  
the number of power cable: for instance, if only one pair of 4awg cable, the rated current of breaker shall be 125A or smaller.
- 4) The Icu required:  
the short circuit current for calculation of each module is 2500A. for instance:

	Icu of breaker
1~4 modules	Must $\geq 10kA$
5~8 modules	Must $\geq 20kA$

## 5.7 Power on

Double check all the power cable and communication cable.

- 1) Switch on all the battery modules:

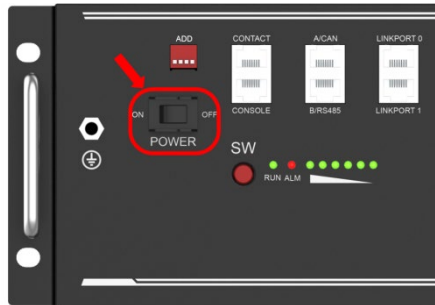

- 2) The one with **empty Link Port 0** is the **Master Battery** Module, others are slaves (1 master battery configure with maximum 15 slave batteries):

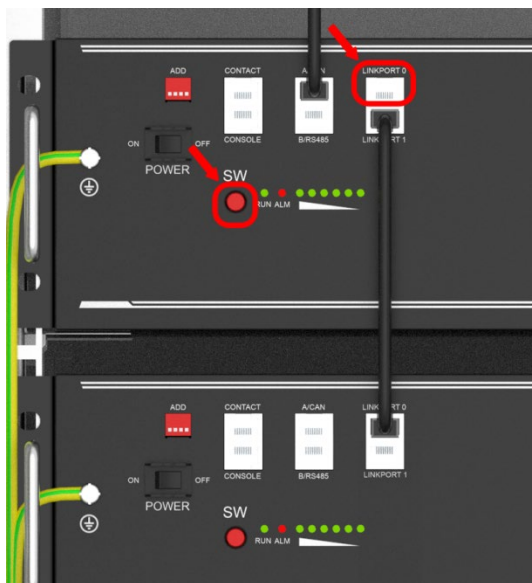

3) Appuyez sur le bouton rouge SW de la batterie principale pour l'allumer, tous les voyants LED de la batterie s'allumeront un par un à partir de la batterie principale:



Note:

- 1) After the battery module powered on, the soft-start function takes **3sec** to active. After soft-starts battery ready to output high power.
- 2) During capacity expansion or replacement, when parallel different SOC/voltage of module together, please maintain the system in idle for  $\geq 15$ mins or till the SOC LEDs becomes similar ( $\leq 1$ dot difference) before normal operation.

## 5.8 Power off

- 1) Turn external power source off.
- 2) Press red SW switch of master battery. Then all batteries will off.
- 3) Switch Power switch OFF.

## 5.9 Multi-group mode

By RS485: DO NOT need LV-HUB.

Connect power cable first:

- 1) each pair of cable hold max 100A constant current. Connect enough pairs of cable based on calculation of system current.
- 2) Suitable protection breaker between battery system and inverter is required.

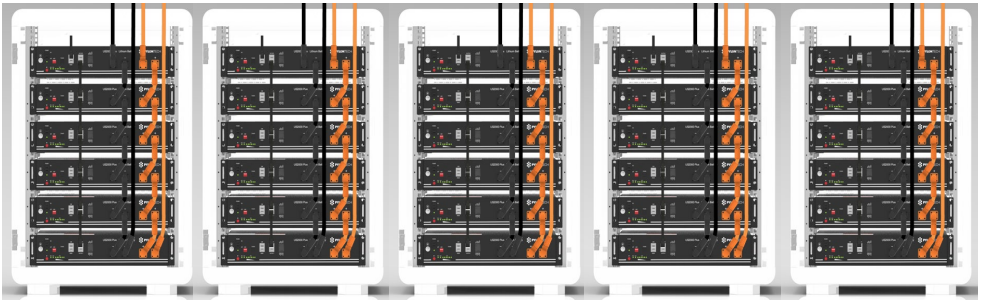

- 3) Make sure all dip switch of master batteries are **R0XX**, then turn ON batteries.  
**R**: is the baud rate of RS485 needed, all master batteries shall be the same.
- 4) After all batteries running and buzzer of master battery in group1 rings 3 times. Means all groups are online.

The interruption of each RS485 command shall at least  $\geq 1s$ .

### Multiple Battery Groups RS485 Communication Cable Connection

Max 6 groups

- 1) The A/CAN of 1<sup>st</sup> group/master battery connects to inverter or EMS(pin: 7A, 8B, **DO NOT connect other pins**)
- 2) The B connect to A of next group; the B/RS485 of last group master battery is empty.

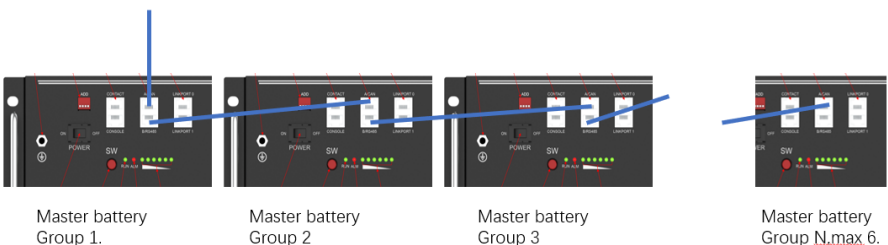

By CAN:

Connect power cable first:

- 1) each pair of cable hold max 100A constant current. Connect enough pairs of cable based on calculation of system current.
- 2) Suitable protection breaker between battery system and inverter is required.
- 3) connect power cable of LV-HUB



- 4) Make sure all dipswitch is X0XX, then turn ON batteries.
- 5) After all batteries running and buzzer of master battery in group1 rings 3 times. Means all groups are online.
- 6) Change the dip switch of **master battery in group1** to X1XX. Then connect communication cable between LV-HUB and master battery in group 1.
- 7) Then turn ON LV-HUB.

Detailed information please refer to manual of LV-HUB.

### Multiple Battery Groups CAN Communication Cable Connection

Each Communication HUB connects maximum 6 battery piles.



- 1) The CAN IN connects to port 0
- 2) The A/CAN connects to port 1~7 freely
- 3) The B connect to A of next group;

the B/RS485 of last group master battery is empty.



Master Battery Group 1



Master Battery Group 2



Master Battery Group 3



Master Battery Group N, max 6

Each battery pile can configure maximum 16pcs US2000C/US3000C.

## 6. Trouble shooting

- Communication related problem

Unable to communicate with inverter on compatible list.

Possible conditions:

- 1) RS485: baud rate. Check the dip switch1, set to correct one, and restart. All master battery shall be the same.
- 2) CAN: terminal resistance. Check the dip switch2, set to 0 and retry.
- 3) CAN: pin. Try connect the CAN-H, L, GND only and do not connect other pins to inverter.

- Functional related problem

- 1) Whether the battery can be turned on or not
- 2) If battery is turned on, check the red light is off, flashing or lighting
- 3) If the red light is off, check whether the battery can be charged/discharged or not.

Possible conditions:

- 1) Battery cannot turn on, switch ON and press the red SW the lights are all no lighting or flashing.
- a) Capacity too low, or module over discharged.

solution: use a charge or inverter to provide 48-53.5V voltage. If battery can start, then keep charge the module and use monitor tools to check the battery log.

If battery terminal voltage is  $\leq 45\text{Vdc}$ , please use  $\leq 0.05\text{C}$  to slowly charge the module to avoid affect to SOH.

If battery terminal voltage is  $> 45\text{Vdc}$ , it can use  $\leq 0.5\text{C}$  to charge.

If battery cannot start, turn off battery and repair.

- 2) The battery can turn on, but red light is lighting, and cannot charge or discharge. If the red light is lighting, that means system is abnormal, please

check values as following

- b) Temperature: Above 60°C or under -10°C, the battery could not work.  
Solution: to move battery to the normal operating temperature range between 0°C and 50°C
  - c) Current: If current exceeds 90A, battery protection will turn on.  
Solution: Check whether current is too large or not, if it is, change the settings on power supply side.
  - d) High Voltage: If charging voltage above 54V, battery protection will turn on.  
Solution: Check whether voltage is too high or not, if it is, to change the settings on power supply side. And discharge the module.
  - e) Low Voltage: When the battery discharges to 44.5V or less, battery protection will turn on.  
Solution: Charge the battery till the red light turns off.
  - f) Cell voltage high. The module voltage is lower than 54V, SOC LED does not all on. When discharge the module protection disappear.  
Solution: keep charge the module by 53-54V or keep the system cycle. The BMS can balance the cell during cycling.
- 3) Unable to charge and discharge with red LED on. The temperature is 0~50 degree. Use charger to charge, not possible. Use load to discharge, not possible.
- g) Under permanent protection. The single cell voltage has been higher than 4.2 or lower than 1.5 or temperature higher than 80 degrees. Solution: Switch off the module and contact your local distributor for repair.
- 4) Unable to charge and discharge without red LED on. The temperature is 0~50 degree. Use charger to charge, not possible. Use load to discharge, not possible.
- h) Fuse broken.  
Solution: Switch off the module and contact your local distributor for repair.
- 5 ) Buzzer rings and **all LED flash**
- i) High voltage protection.



Cell voltage higher than 4V or module voltage higher than 55.5V.

Solution: **Battery system requires properly established communication with inverter and correctly settings on inverter to run safely.** Check the setting of the inverter or charger, the charge voltage shall be 53.2~52.5Vdc; Check the communication between battery system and inverter whether established or not; Check the ADD switch on battery module whether is set correctly or not;

Under this condition, the BMS remains functional without damage. Just leave the module switched OFF and wait for the battery voltage drop down naturally(15mins) then restart. If then no alarm comes out, this means the module is ready for work

6 ) Buzzer rings and **ALM solid red**

j) Reverse connection of cables.

Solution: Power off all battery and inverters. Disconnect breaker. Check the cable connection and disconnect all power cables. Check the power port damaged or not. Then try turn on the single module, without any cable connected. If no alarm, then it is reverse connection of cables. Switch off the module and contact your local distributor.

k) MOSFAIL.

Solution: Power off all battery and inverters. Disconnect breaker. Check the cable connection and disconnect all power cables. Check the power port damaged or not. Check the setting of inverter or charger, check the communication between inverter and battery system.

Try turn on the single module, without any cable connected. If still buzzer rings. Then switch off the module and contact your local distributor.

7 ) After switch On, the module turns on directly

l) BMS failure.

Solution : Switch off the module and contact your local distributor.

**Excluding the points above, if the faulty still cannot be located, turn off battery and contact your local distributor.**

## **7. Emergency Situations**

### **1) Leaking Batteries**

If the battery pack leaks electrolyte, avoid contact with the leaking liquid or gas. If one is exposed to the leaked substance, immediately perform the actions described below.

- a) Inhalation: Evacuate the contaminated area and seek medical attention.
- b) Contact with eyes: Rinse eyes with flowing water for 15 minutes and seek medical attention.
- c) Contact with skin: Wash the affected area thoroughly with soap and water and seek medical attention.

Ingestion: Induce vomiting and seek medical attention.

### **2) Fire**

**NO WATER!** Only dry powder fire or carbon dioxide extinguisher can be used; if possible, move the battery pack to a safe area before it catches fire.

### **3) Wet Batteries**

If the battery pack is wet or submerged in water, do not let people access it, and then contact Pylontech or an authorized dealer for technical support. Cut off all power switch on inverter side.

### **4) Damaged Batteries**

Damaged batteries are dangerous and must be handled with the utmost care. They are not fit for use and may pose a danger to people or property. If the battery pack seems to be damaged, pack it in its original container, and then return it to Pylontech or an authorized dealer.



### **Caution**

Damaged batteries may leak electrolyte or produce flammable gas.

## 8. Remarks

### Recycle and disposal

In case a battery (normal condition or damaged) needs disposal or needs recycling, it shall follow the local recycling regulation (i.e. Regulation (EC) N° 1013/2006 among European Union) to process, and using the best available techniques to achieve a relevant recycling efficiency.

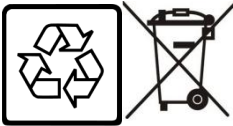

**Li-ion** 

### Storage, Maintenance and Expansion

- 1) It is required to charge the battery at least once every 12 months, for this charge maintenance make sure the SOC is charged to higher than 90%
- 2) Every year after installation. The connection of power connector, grounding point, power cable and screw are suggested to be checked. Make sure there is no loose, no broken, no corrosion at connection point. Check the installation environment such as dust, water, insect etc. make sure it is suitable for IP20 battery system.
- 3) If the battery is stored for long time, it is required to charge them every six months, and the SOC should be higher than 90%.
- 4) A new battery module can be added onto an existing system at any time. Please make sure the new battery is acting as the master. The new module, due to a higher SOH may have a difference on SOC with existing system, but it will not affect the parallel connection system performance.



**PYLONTECH**

**Pylon Technologies Co., Ltd.**

5/F, No.71-72, Lane 887, ZuChongzhi Road, China (Shanghai) Pilot Free Trade Zone, Pudong, Shanghai 201203, China

**T**+86-21-51317699 | **F** +86-21-51317698

**E** [service@pylontech.com.cn](mailto:service@pylontech.com.cn)

**W** [www.pylontech.com.cn](http://www.pylontech.com.cn)